

High Pressure Coolant Valve

- Max. operating pressure: 3 MPa, 7 MPa, **10 MPa, 14 MPa**
- Applicable to high-speed grinding and long drilling processes
- Coolant valve for high-pressure coolant liquid that is ideal for lubrication, dust blowing, and cooling

Service life: **3 million cycles**

(Based on SMC's test conditions)

Water hammer: Reduced by **20%**
(2-port)

(Compared to existing model, VNH series)

Power consumption: **0.35 w**

(24 VDC, V116)
(With light/surge voltage suppressor: 0.58 W)

The 3-port dual pressure type has been standardized.

(See application examples 1 and 2 on page 2.)

New 10 and 14 MPa specifications have been added.

Improved machining accuracy

- Improved machining surface finish
- Allows for the machining of difficult-to-machine materials

Easy maintenance

- Improved machining chips handling
- Improved life of cutting tools (Improved cooling and lubrication)



Flow rate characteristics (2-port)

Pressure	Kv
7 MPa	1.5 (1.8) to 5.5 (6.5)
10 MPa	1.0 (1.3)
14 MPa	0.9 (1.1)

(): Cv factor



SGH Series



CAT.ES70-37B 

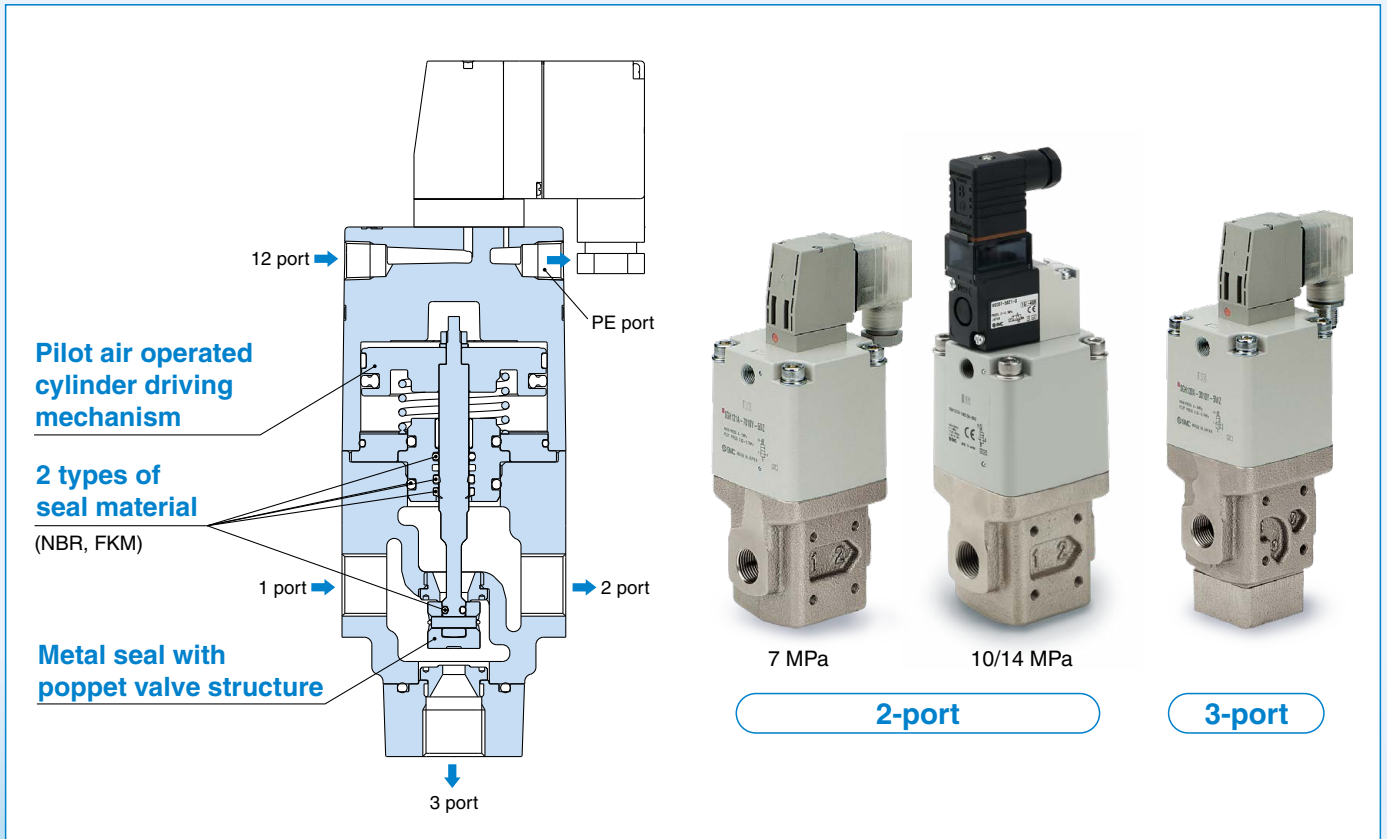

Variations

Port	Type of actuation	Pressure specifications	Orifice diameter ϕ [mm]		Flow rate characteristics Kv (): Conversion Cv		Port size	Rated voltage
			1 \rightarrow 2	1 \rightarrow 3	1 \rightarrow 2	1 \rightarrow 3		
2-port	External pilot solenoid type Air operated type	7 MPa	$\phi 7.5$	—	1.5 (1.8)	—	3/8	100 VAC 50/60 Hz 200 VAC 50/60 Hz 110 VAC [115 VAC] 50/60 Hz 220 VAC [230 VAC] 50/60 Hz 24 VDC 12 VDC
			$\phi 9.4$	—	2.3 (2.7)	—	1/2	
			$\phi 12.4$	—	4.0 (4.7)	—	3/4	
			$\phi 15.4$	—	5.5 (6.5)	—	1	
3-port		3 MPa	$\phi 10.2$ equiv.	$\phi 9.4$	1.8 (2.1)	2.0 (2.3)	3/8	
			$\phi 13.7$ equiv.	$\phi 12$	3.2 (3.8)	3.3 (3.8)	1/2	
			$\phi 15.9$ equiv.	$\phi 15.2$	4.8 (5.6)	5.0 (5.8)	1	
			7 MPa	$\phi 6.3$ equiv.	$\phi 6$	0.9 (1.1)	0.8 (1.0)	
	$\phi 8.1$ equiv.	$\phi 7.6$		1.6 (1.9)	1.8 (2.0)	1/2		
	$\phi 11.3$ equiv.	$\phi 10$		2.8 (3.3)	2.3 (2.7)	3/4		
	$\phi 13.2$ equiv.	$\phi 11.5$		3.6 (4.3)	3.0 (3.5)	1		

Electrical entry

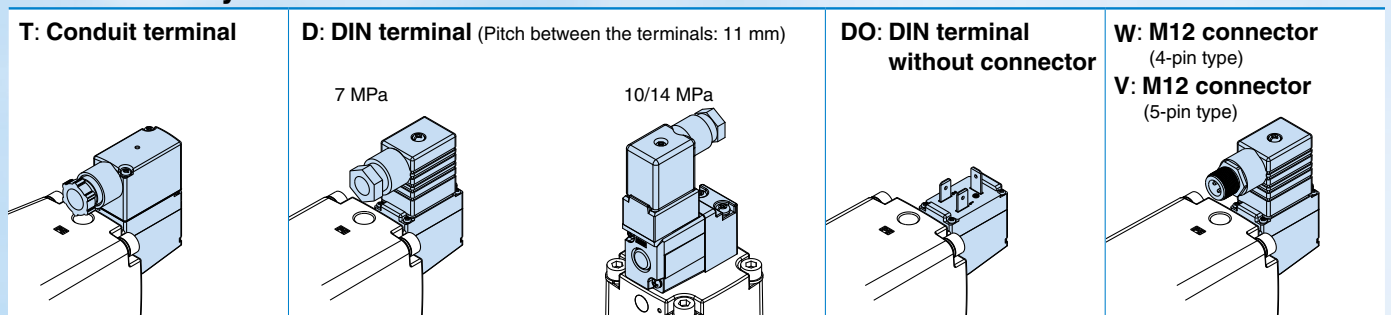

Application examples

For supplying to the main spindle drill

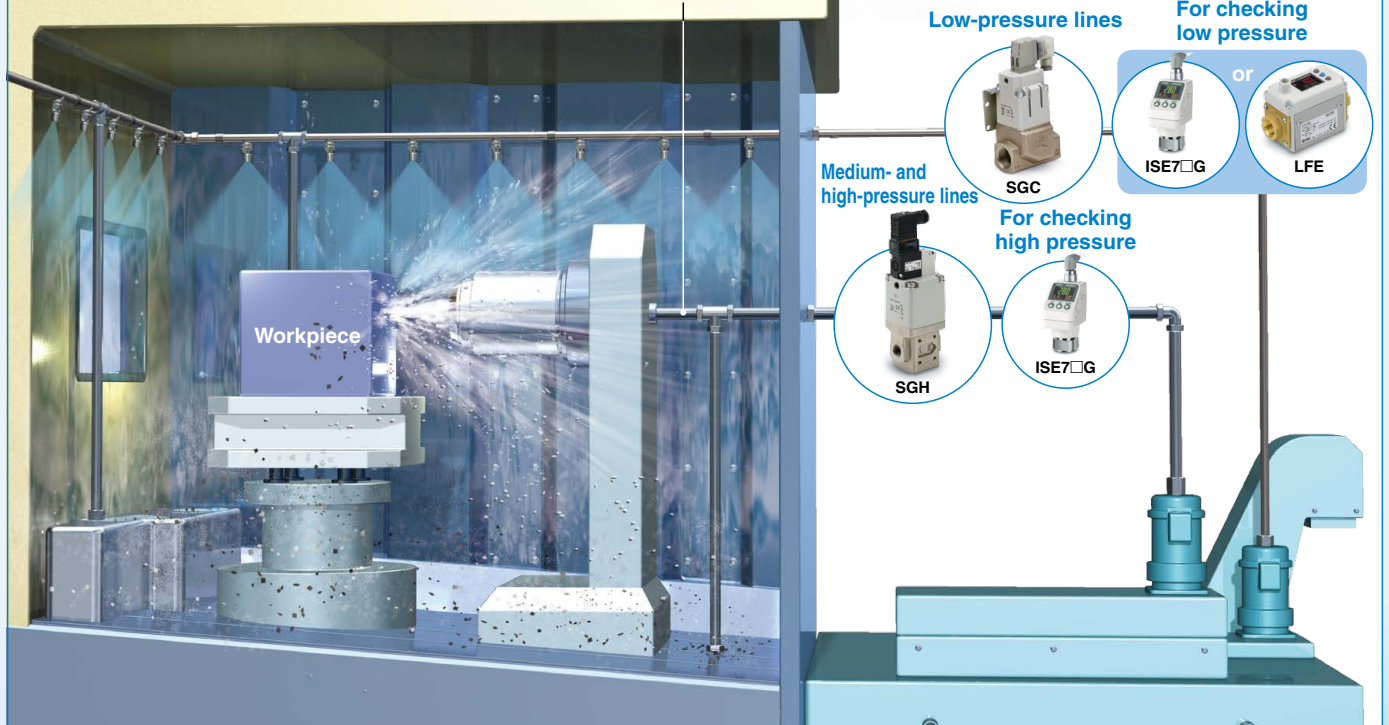

Application examples

Example 1 3-port dual pressure, N.C. type

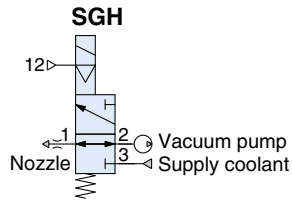

Fluid leakage can be avoided.

Example 2 3-port dual pressure, Selector type

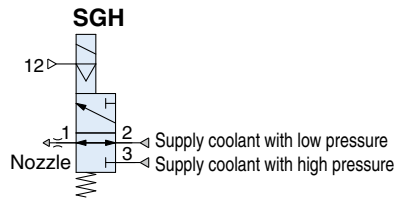

Coolant can be supplied at different pressures.

Example 3 2-port, For turning nozzles ON/OFF

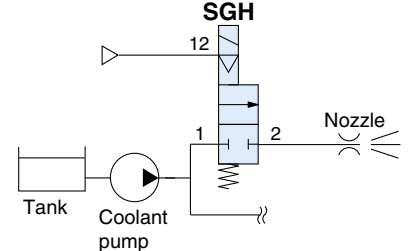

Example 4 3-port, For reducing the pump load

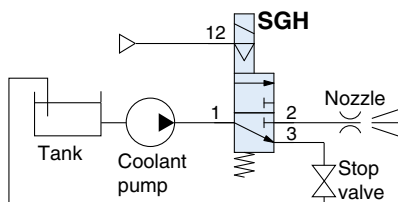

To reduce the pump load, coolant liquid is returned to the tank from the B port each time.

Example 5 3-port, For switching nozzles

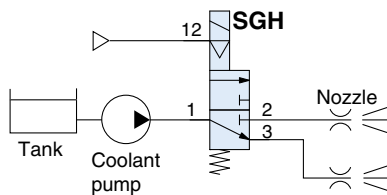

For switching between 2 nozzles
It can be used as a 2-port valve by plugging the 3(B) port.

CONTENTS

How to Order 2-Port Type	p. 3	Replacement Parts	p. 9
How to Order 3-Port Type	p. 5	Dimensions: 2-Port	p. 10
Flow Rate Characteristics	p. 6	Dimensions: 3-Port	p. 13
Valve Specifications	p. 6	Options	p. 17
Construction	p. 7	Made to Order	p. 18
Pilot Solenoid Valve: Single Unit	p. 8	Specific Product Precautions	p. 19

Coolant Valve

SGH Series



How to Order 2-Port Type

* A filter is installed on the PE port as standard.

External pilot solenoid

SGH 1 2 1 A - 70 G 10 Y - 1 T Z - B1

Air operated

SGHA 1 2 1 A - 70 G 10 - B1

1 2 3 4 5 6 7 8 9 10 11 12

1 Series

1	SGH100
2	SGH200
3	SGH300
4	SGH400

2 Valve type

1	N.C.
2*1	N.O.

*1 Only the pressure range "70" can be selected.

3 Seal material

A	NBR
B	FKM

4 Pressure range

70	Pressure range 0 to 7 MPa
100*2	Pressure range 0 to 10 MPa
140*2	Pressure range 0 to 14 MPa

*2 Only the SGH(A)100 series can be selected.

5 Thread type

Nil	Rc
G	G (ISO1179-1)
N	NPT
T	NPTF

6 Port size

10	3/8	SGH100
15	1/2	SGH200
20	3/4	SGH300
25	1	SGH400

7 Pilot valve

Y	V116	For 7 MPa
H	VO307	For 10/14 MPa

8 Rated voltage

1	100 VAC 50/60 Hz
2	200 VAC 50/60 Hz
3	110 VAC [115 VAC] 50/60 Hz
4	220 VAC [230 VAC] 50/60 Hz
5	24 VDC
6	12 VDC

* Refer to page 19 when energizing for long periods of time.

10 Light/surge voltage suppressor

Nil	None
S	With surge voltage suppressor (Non-polar)
Z	With light/surge voltage suppressor

* Refer to Table 1 on page 4 for combinations with electrical entries.

9 Electrical entry

For 7 MPa (at V116)			
T: Conduit terminal (Pilot valve V116 only)*6 	D: DIN terminal (Pitch between the terminals: 11 mm) 	DO: DIN terminal without connector *3 	W: M12 connector (4-pin type) *4 V: M12 connector (5-pin type) *4, *5
For 10/14 MPa (at VO307)			
	D: DIN terminal (Pitch between the terminals: 11 mm) 	DO: DIN terminal without connector *3 	W: M12 connector (4-pin type) *4 V: M12 connector (5-pin type) *4, *5

*3 Refer to Table 1 on page 4 for combinations with light/surge voltage suppressors.

*4 A cable for the M12 connector is not included with the product. Refer to "Options" on page 17 and order it separately.

*5 Only DC voltage can be selected.

*6 The H: VO307 type cannot be selected.



11 Manual override

For 7 MPa (Pilot valve: V116)		For 10/14 MPa (Pilot valve: VO307)
Nil: Non-locking push type 	D: Push-turn locking slotted type 	Nil: Non-locking push type



Made to Order

Specifications (For details, refer to page 18.)
Connector entry direction selection

12 Bracket

For 7 MPa (Pilot valve: V116)			For 10/14 MPa (Pilot valve: VO307)		
Nil: Without bracket 	B1: Bracket on the left side 	B2: Bracket on the right side 	Nil: Without bracket 	B1: Bracket on the left side 	B2: Bracket on the right side

Table 1 Electrical Entry/Light/Surge Voltage Suppressor

Pilot valve	Rated voltage	Electrical entry	Without light/surge voltage suppressor	With surge voltage suppressor	With light/surge voltage suppressor
			Nil	S	Z
V116	AC	T	—	●	●
		D	—	●	●
		W	—	—	—
	DC	DO	●*1	—	—
		T	—	—	—
		D	●	●	●
VO307	AC	W, V	—	—	—
		DO	●	—	—
		D	●	—	●
	DC	W, V	—	—	—
		DO	●	—	●
		D	●	—	●

*1 If an AC specification (V116) without a DIN terminal (DO) is selected, always use a DIN connector with a surge voltage suppressor as the connector.

Options

(For details, refer to page 17.)

Cable for M12 connector

V100-200-1-4

Specifications		Cable length (L)	
4-pin type	1	4	1000 [mm]
	2	8	3000 [mm]
5-pin type	3	9	5000 [mm]

* When selecting the 5-pin type, only DC voltage can be selected.

SGH Series



External pilot solenoid

Air operated

How to Order 3-Port Type

* A filter is installed on the PE port as standard.

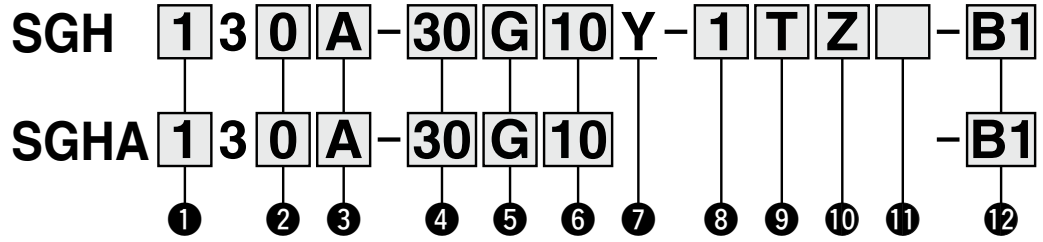

1 Series

1	SGH100
2	SGH200
3	SGH300
4	SGH400

2 Valve type

0	3-port
3	3-port*1 dual pressure type

*1 The flow direction of the fluid is not the same as the arrow on the body.

3 Seal material

A	NBR
B	FKM

5 Thread type

Nil	Rc
G	G (ISO1179-1)
N	NPT
T	NPTF



Made to Order

Specifications (For details, refer to page 18.)
Connector entry direction selection

4 Pressure range

30	Pressure range 0 to 3 MPa
70	Pressure range 0 to 7 MPa

6 Port size

10	3/8	SGH100
15	1/2	SGH200
20	3/4	SGH300
25	1	SGH400

7 Pilot valve

Y	V116
---	------

8 Rated voltage

1	100 VAC 50/60 Hz
2	200 VAC 50/60 Hz
3	110 VAC [115 VAC] 50/60 Hz
4	220 VAC [230 VAC] 50/60 Hz
5	24 VDC
6	12 VDC

9 Electrical entry

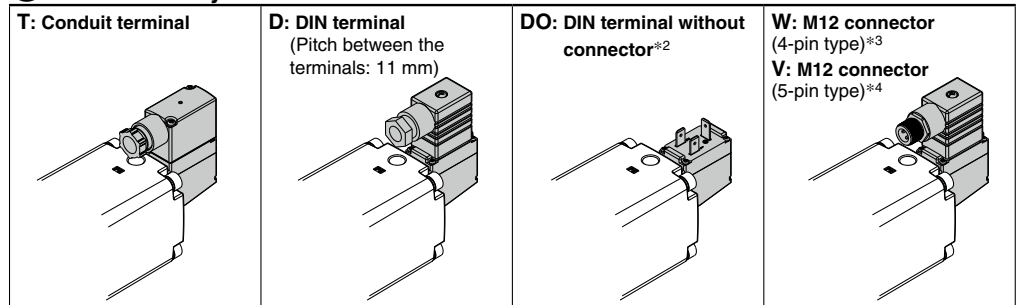

*2 Refer to Table 1 below for combinations with light/surge voltage suppressors.

*3 A cable is not included with the product. Refer to "Options" on page 17 and order it separately.

*4 Only DC voltage can be selected.

10 Light/surge voltage suppressor

Nil	None
S	With surge voltage suppressor (Non-polar)
Z	With light/surge voltage suppressor (Non-polar)

* Refer to Table 1 below for combinations with electrical entries.

* DOS and DOZ are not available.

* For AC specifications, Nil is only set for electrical entry DO.

11 Manual override

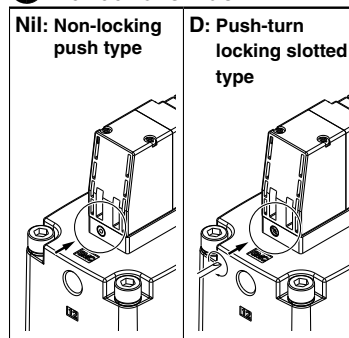

12 Bracket

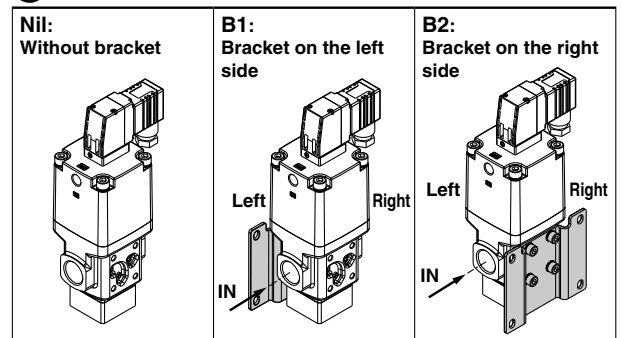

Table 1 Electrical Entry/Light/Surge Voltage Suppressor

Rated voltage	Electrical entry	Without light/surge voltage suppressor	With surge voltage suppressor	With light/surge voltage suppressor
		Nil	S	Z
AC	T	—	●	●
	D	—	●	●
	W	—	—	—
	DO	●*5	—	—
DC	T	●	●	●
	D	●	●	●
	W, V	—	—	—
	DO	●	—	—

*5 If an AC specification without a DIN terminal (DO) is selected, always use a DIN connector with a surge voltage suppressor as the connector.

Options

(For details, refer to page 17.)

Cable for M12 connector

V100-200-1-4

Specifications

4-pin type	1	DC
	2	AC
5-pin type	3	DC

Cable length (L)

4	1000 [mm]
8	3000 [mm]
9	5000 [mm]

* When selecting the 5-pin type, only DC voltage can be selected.

Flow Rate Characteristics

Port	Pressure specifications	Model	Port size	Orifice diameter ϕ [mm]		Flow rate characteristics Kv (): Conversion Cv		Weight [kg] (): With bracket	
				1 → 2	1 → 3	1 → 2	1 → 3	Air operated	External pilot solenoid
2-port	7 MPa	SGH(A)12□□-70□10	3/8	$\phi 7.5$	—	1.5 (1.8)	—	1.3 (1.4)	1.4 (1.5)
		SGH(A)22□□-70□15	1/2	$\phi 9.4$	—	2.3 (2.7)	—	2.3 (2.5)	2.4 (2.6)
		SGH(A)32□□-70□20	3/4	$\phi 12.4$	—	4.0 (4.7)	—	4.6 (5.2)	4.7 (5.3)
		SGH(A)42□□-70□25	1	$\phi 15.4$	—	5.5 (6.5)	—	6.5 (7.1)	6.6 (7.2)
2-port	10 MPa	SGH(A)12□□-100□10	3/8	$\phi 6$	—	1.0 (1.3)	—	1.4 (1.5)	1.6 (1.7)
	14 MPa	SGH(A)12□□-140□10	3/8	$\phi 5.5$	—	0.9 (1.1)	—	1.4 (1.5)	1.6 (1.7)
3-port	3 MPa	SGH(A)13□□-30□10	3/8	$\phi 10.2$ equiv.	$\phi 9.4$	1.8 (2.1)	2.0 (2.3)	1.5 (1.6)	1.6 (1.7)
		SGH(A)23□□-30□15	1/2		$\phi 10.5$	2.0 (2.3)	2.6 (3.0)	1.5 (1.6)	1.6 (1.7)
		SGH(A)33□□-30□20	3/4	$\phi 13.7$ equiv.	$\phi 12$	3.2 (3.8)	3.3 (3.8)	2.5 (2.7)	2.6 (2.8)
		SGH(A)43□□-30□25	1	$\phi 15.9$ equiv.	$\phi 15.2$	4.8 (5.6)	5.0 (5.8)	4.7 (5.3)	4.8 (5.4)
	7 MPa	SGH(A)13□□-70□10	3/8	$\phi 6.3$ equiv.	$\phi 6$	0.9 (1.1)	0.8 (1.0)	1.5 (1.6)	1.6 (1.7)
		SGH(A)23□□-70□15	1/2	$\phi 8.1$ equiv.	$\phi 7.6$	1.6 (1.9)	1.8 (2.0)	2.5 (2.7)	2.6 (2.8)
		SGH(A)33□□-70□20	3/4	$\phi 11.3$ equiv.	$\phi 10$	2.8 (3.3)	2.3 (2.7)	4.7 (5.3)	4.8 (5.4)
		SGH(A)43□□-70□25	1	$\phi 13.2$ equiv.	$\phi 11.5$	3.6 (4.3)	3.0 (3.5)	6.3 (6.9)	6.4 (7.0)

Valve Specifications

Fluid	Coolant (This product cannot be used for water applications.)		
Fluid temperature	-10 to 60°C*1		
Ambient temperature	-10 to 50°C*1		
Proof pressure	SGH(A)□□□□-30	4.5 MPa	
	SGH(A)□□□□-70	10.5 MPa	
	SGH(A)□□□□-100	15 MPa	
	SGH(A)□□□□-140	21 MPa	
Leakage from the valve seat	20 cm ³ /min or less (Coolant pressure)		
Operating pressure range	SGH(A)□□□□-30	0 to 3 MPa	
	SGH(A)□□□□-70	0 to 7 MPa	
	SGH(A)□□□□-100	0 to 10 MPa	
	SGH(A)□□□□-140	0 to 14 MPa	
Pilot air	Pressure	SGH(A)□□□□- ¹⁰⁰ / ₇₀ / ₃₀	0.25 to 0.7 MPa
		SGH(A)121□-140	0.35 to 0.7 MPa
	Lubrication	Not required (Use Class 1 (ISO VG32) turbine oil if lubricating.)	
	Temperature	-10 to 50°C*1	

*1 No freezing

* The flow direction of the fluid is not the same as the arrow on the body. Refer to pages 15 and 16.

Symbol

Valve type Type of actuation	2-port		3-port	3-port dual pressure type
	N.C.	N.O.		
Air operated type				
External pilot solenoid type				

* For the 3-port dual pressure type, it is not possible to pressurize from port 1.

3-Port Dual Pressure Type

① Application example, N.C. type

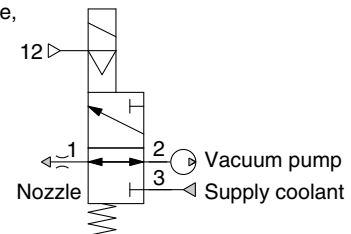

② Application example, Selector type

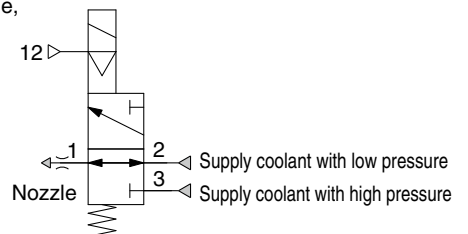

SGH Series

Construction

2-port valve (N.C.)

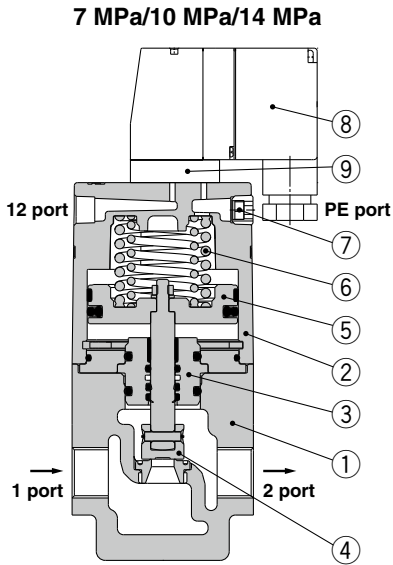

3-port valve

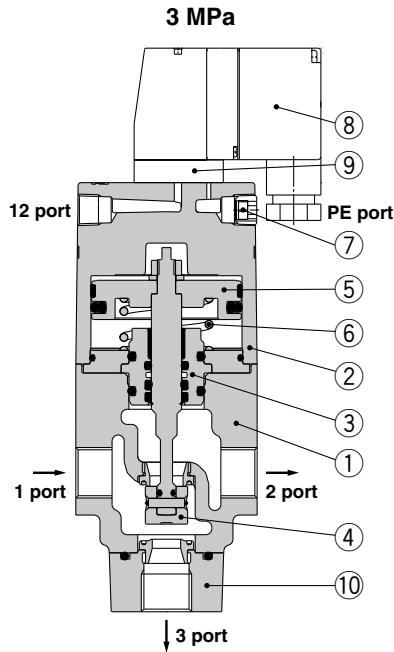

3-port valve (Dual pressure type)

* The flow direction of the fluid is not the same as the arrow on the body.

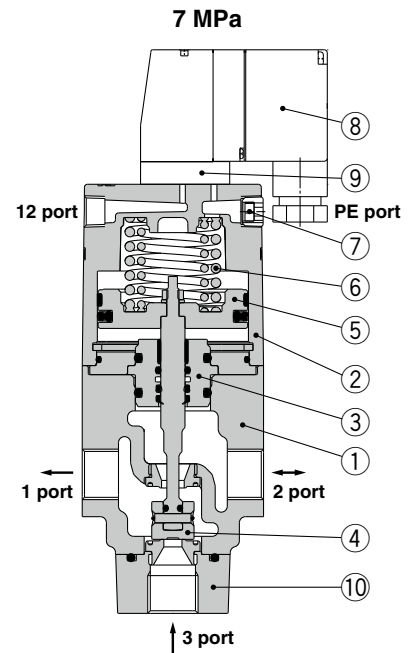
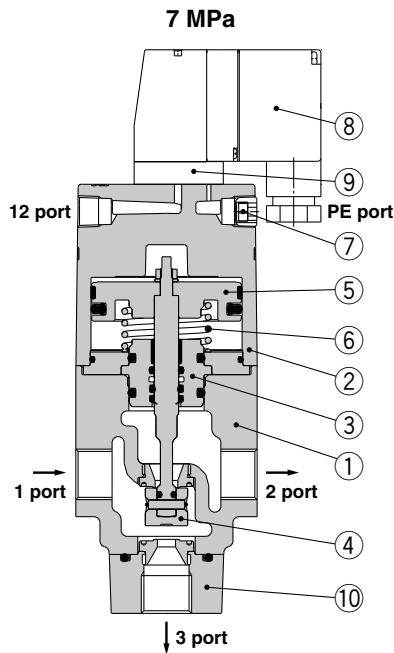
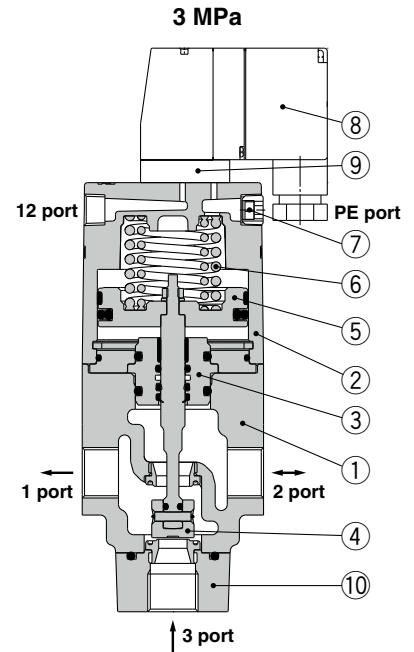

Component Parts

No.	Description	Material	Note
1	Body assembly	Cast iron	Plating
2	Cover	Aluminum die-casted	White
3	Plate assembly	Iron	Valve component, NBR, FKM
4	Valve body	Stainless steel	—
5	Piston assembly	Stainless steel, Aluminum	—
6	Return spring	Stainless steel	—
7	Filter	BC	Replaceable part (Refer to page 9.)
8	Pilot solenoid valve	—	Replaceable part (Refer to page 8.)
9	Adapter plate assembly	—	Replaceable part (Refer to page 9.)
10	Undercover assembly	Cast iron	Plating, only for 3-port valve
—	Bracket	Iron	Replaceable part (Refer to page 9.)

Pilot Solenoid Valve: Single Unit**How to Order****For 3/7 MPa (V116)**
V116-5TZ-1

①
②
③

① Rated voltage

1	100 VAC 50/60 Hz
2	200 VAC 50/60 Hz
3	110 VAC [115 VAC] 50/60 Hz
4	220 VAC [230 VAC] 50/60 Hz
5	24 VDC
6	12 VDC

② Electrical entry

T	Conduit terminal
D	DIN terminal (with connector)
DO	DIN terminal (without connector)
W	M12 connector (4-pin type)
V	M12 connector (5-pin type)*1

*1 Only DC voltage can be selected.

③ Light/surge voltage suppressor

Nil	None
S	With surge voltage suppressor (Non-polar)
Z	With light/surge voltage suppressor (Non-polar)

* Refer to Table ① on pages 4 and 5 for combinations with electrical entries.

* DOS and DOZ are not available.

* For AC specifications, Nil is only set for electrical entry DO.

Specifications

Model		V116-□□□-1	
Electrical entry		Conduit terminal, DIN terminal, M12 connector	
Coil rated voltage	DC	12 V, 24 V	
	AC (50/60 Hz)	100 V, 110 V, 200 V, 220 V	
Allowable voltage range		±10% of the rated voltage*2	
Power consumption	DC	0.35 W (With indicator light: 0.58 W)	
Apparent voltage	AC	100 V	0.78 VA (With indicator light: 0.87 VA)
		110 V [115 V]	0.86 VA (With indicator light: 0.97 VA) [0.94 VA (With indicator light: 1.07 VA)]
		200 V	1.15 VA (With indicator light: 1.30 VA)
		220 V [230 V]	1.27 VA (With indicator light: 1.46 VA) [1.39 VA (With indicator light: 1.60 VA)]
Surge voltage suppressor		ZNR (Varistor)	
Indicator light		LED (Neon bulb when AC with DIN terminal and M12 connector)	
Enclosure		IEC60529 standard IP65, JIS C0920	

*2 In common between 110 VAC and 115 VAC, and between 220 VAC and 230 VAC.

*2 For 115 VAC and 230 VAC, the allowable voltage range is -15% to +5% of the rated voltage.

How to Order**For 10/14 MPa (VO307)****Electrical entry: DIN terminal**
VO307Y-5DZ1-X409-Q

①
②
③

Electrical entry: DIN terminal without connector
VO307Y-5DOZ1-Q

①
②
③

Electrical entry: M12 connector
VO307Y-5DZ1-W-X408-Q

①
②
③
④

① Voltage

Nil	AC
Y	DC

② Rated voltage

1	100 VAC 50/60 Hz
2	200 VAC 50/60 Hz
3	110 VAC 50/60 Hz
4	220 VAC 50/60 Hz
5	24 VDC
6	12 VDC

③ Light/surge voltage suppressor

Nil	None
Z	With light/surge voltage suppressor

* Refer to Table ① on page 4 for combinations with electrical entries.

④ Electrical entry

W	M12 connector (4-pin type)
V	M12 connector (5-pin type)*1

*1 Only DC voltage can be selected.

Specifications

Model		VO307(Y)-□□□1(-X408, 409)-Q	
Electrical entry		DIN terminal, M12 connector	
Coil rated voltage	DC	12 V, 24 V	
	AC (50/60 Hz)	100 V, 110 V, 200 V, 220 V	
Allowable voltage range		-15 to +10% of the rated voltage	
Power consumption	DC	1.8 W (With indicator light: 2 W)	
Apparent voltage	AC	Starting	12.7 VA (50 Hz), 10.7 VA (60 Hz)
		Energized	7.6 VA (50 Hz), 5.4 VA (60 Hz)
Light/surge voltage suppressor	DC	Diode, LED	
	AC (50/60 Hz)	Varistor, LED	
Enclosure		Dustproof	

SGH Series

Replacement Parts

Bracket Part No.

Series	Port	Pressure specifications	Part no.
SGH100	2-port	7 MPa/10 MPa/ 14 MPa	SGH1-16-1A
	3-port	3 MPa	
		7 MPa	
SGH200	2-port	7 MPa	SGH2-16-1A
	3-port	3 MPa	SGH1-16-1A
		7 MPa	SGH2-16-1A
SGH300	2-port	7 MPa	SGH3-16-1A
	3-port	3 MPa	SGH2-16-1A
		7 MPa	SGH3-16-1A
SGH400	2-port	7 MPa	SGH4-16-1A
	3-port	3 MPa	SGH3-16-1A
		7 MPa	SGH4-16-1A

Filter Part No.

Series	Pressure specifications	Thread type	
		Ni/G	N/T
SGH100	3 MPa	EBKX-W4005	EBKY-D8006
	7 MPa/10 MPa/ 14 MPa		
SGH200	7 MPa		
	3 MPa		
SGH300	7 MPa		
	3 MPa		
SGH400	3 MPa		
	7 MPa		

Adapter Plate Assembly Part No.: For 3/7 MPa (V116)

Manual override	Part no.
Non-locking push type	SGC2-13-1A
Push-turn locking slotted type	SGC2-13-1DA

Dimensions: 2-Port, 7 MPa/10 MPa/14 MPa

Air operated type

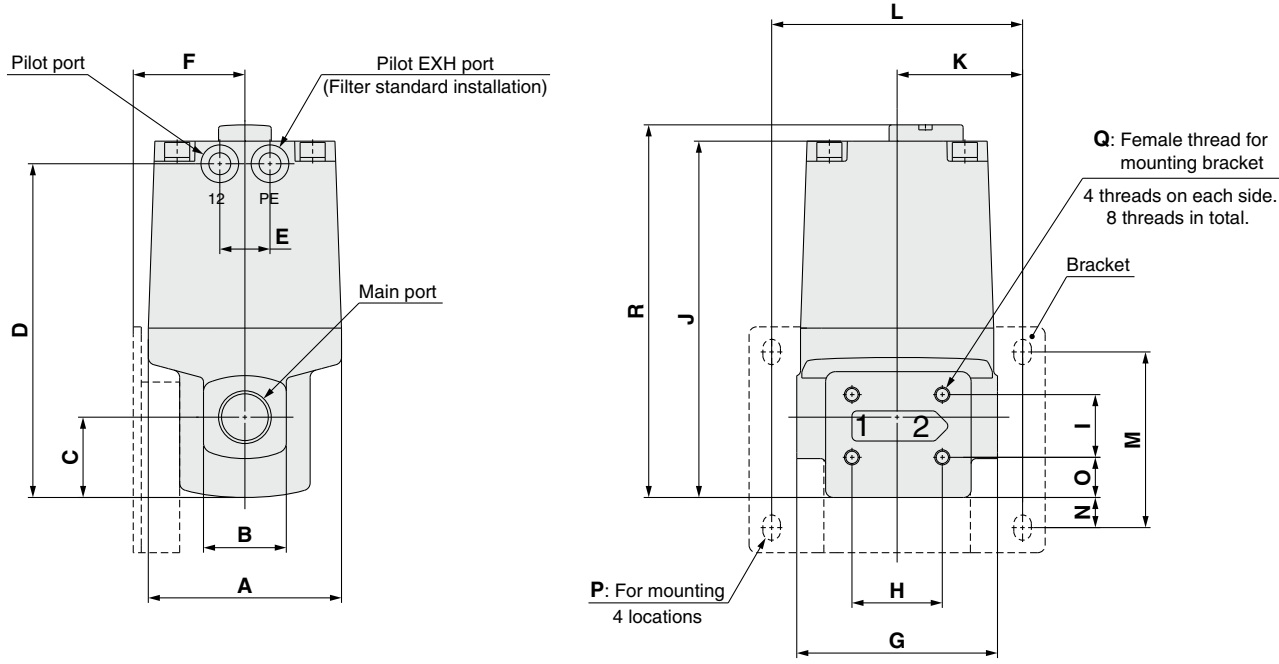

Air Operated Type

Model	Main port	Pilot port	A	B	C	D	E	F	G	H	I	J	K	L	M	N	O
SGHA12□- ¹⁴⁰ / ₁₀₀ -7010	2 x 3/8	1/8	60	28	29	116	—	34	60	24	29	125	37.5	75	62	10.5	16
SGHA22□-7015	2 x 1/2	1/8	77	33	32	133	20	44.5	80	36	25	142	50	100	70	12	16
SGHA321-7020	2 x 3/4	1/4	96	43	39	157	24	60.5	100	49	34	169	63	126	92	20.5	19
SGHA322-7020	2 x 3/4	1/4	96	43	39	142	24	60.5	100	49	34	154	63	126	92	20.5	19
SGHA421-7025	2 x 1	1/4	113	48	43	173	24	66.5	115	56	38	185	70.5	141	109	31.3	19
SGHA422-7025	2 x 1	1/4	113	48	43	149	24	66.5	115	56	38	161	70.5	141	109	31.3	19

Model	P	Q	R
SGHA12□- ¹⁴⁰ / ₁₀₀ -7010	For M5	M5	131.5
SGHA22□-7015	For M6	M6	148.5
SGHA321-7020	For M8	M8	175.5
SGHA322-7020	For M8	M8	160.5
SGHA421-7025	For M8	M8	191.5
SGHA422-7025	For M8	M8	167.5

SGH Series

Dimensions: 2-Port, 7 MPa

External pilot solenoid type

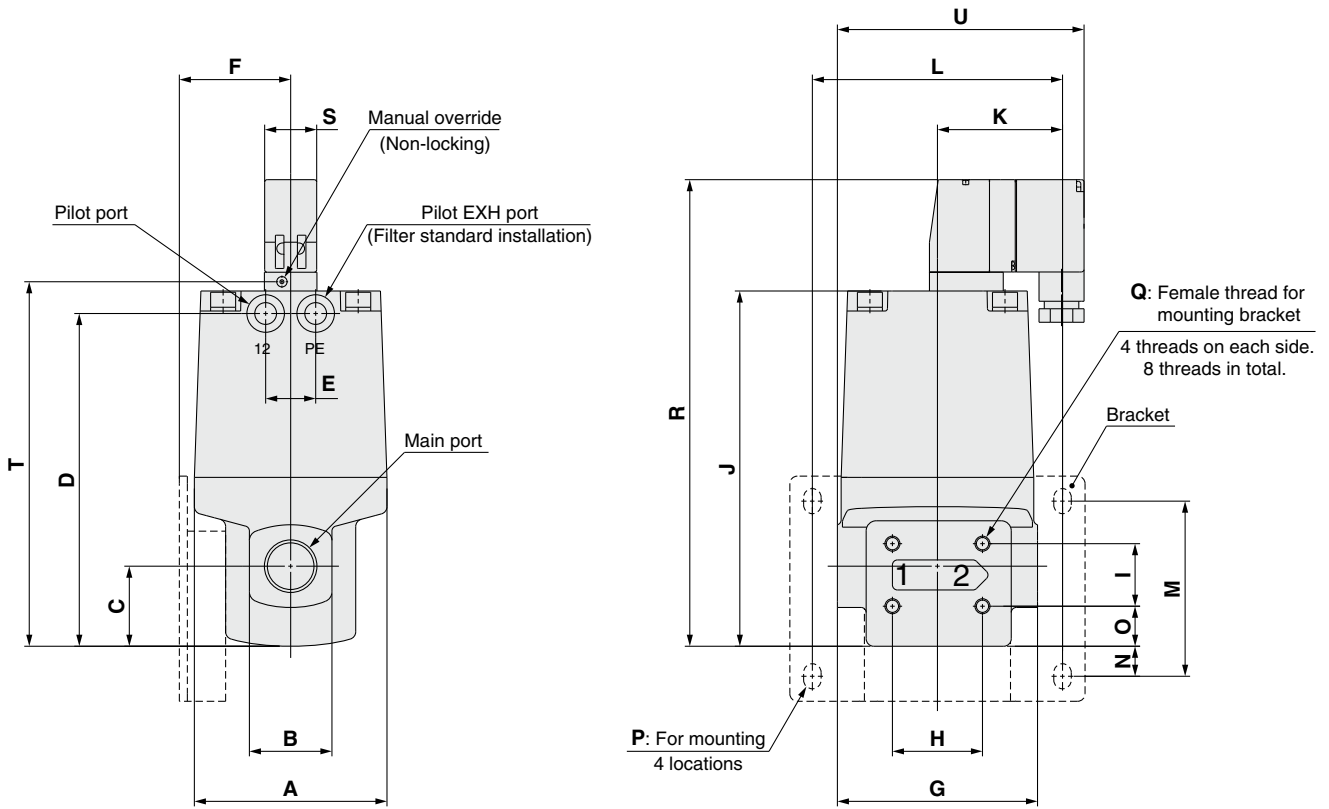

* Drawing indicates conduit terminal type.

External Pilot Solenoid Type (Conduit terminal)

Model	Main port	Pilot port	A	B	C	D	E	F	G	H	I	J	K	L	M	N	O
SGH12□-7010	2 x 3/8	1/8	60	28	29	116	—	34	60	24	29	125	37.5	75	62	10.5	16
SGH22□-7015	2 x 1/2	1/8	77	33	32	133	20	44.5	80	36	25	142	50	100	70	12	16
SGH321-7020	2 x 3/4	1/4	96	43	39	157	24	60.5	100	49	34	169	63	126	92	20.5	19
SGH322-7020	2 x 3/4	1/4	96	43	39	142	24	60.5	100	49	34	154	63	126	92	20.5	19
SGH421-7025	2 x 1	1/4	113	48	43	173	24	66.5	115	56	38	185	70.5	141	109	31.3	19
SGH422-7025	2 x 1	1/4	113	48	43	149	24	66.5	115	56	38	161	70.5	141	109	31.3	19

Model	P	Q	R	S	T	U
SGH12□-7010	For M5	M5	169.5	20.8	128.7	81.1
SGH22□-7015	For M6	M6	186.5	20.8	145.7	98.6
SGH321-7020	For M8	M8	213.5	20.8	172.7	117.6
SGH322-7020	For M8	M8	198.5	20.8	157.7	117.6
SGH421-7025	For M8	M8	229.5	20.8	188.7	133.6
SGH422-7025	For M8	M8	205.5	20.8	164.7	133.6

External Pilot Solenoid Type (DIN terminal)

Model	U
SGH12□-7010	86.8
SGH22□-7015	104.3
SGH321-7020	123.3
SGH322-7020	123.3
SGH421-7025	139.3
SGH422-7025	139.3

DIN terminal

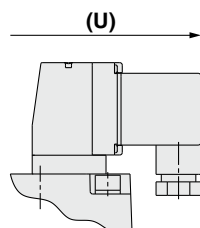

External Pilot Solenoid Type (M12 connector)

Model	U
SGH12□-7010	86.8
SGH22□-7015	104.3
SGH321-7020	123.3
SGH322-7020	123.3
SGH421-7025	139.3
SGH422-7025	139.3

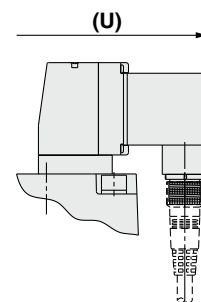

Dimensions: 2-Port, 10 MPa/14 MPa

External pilot solenoid type

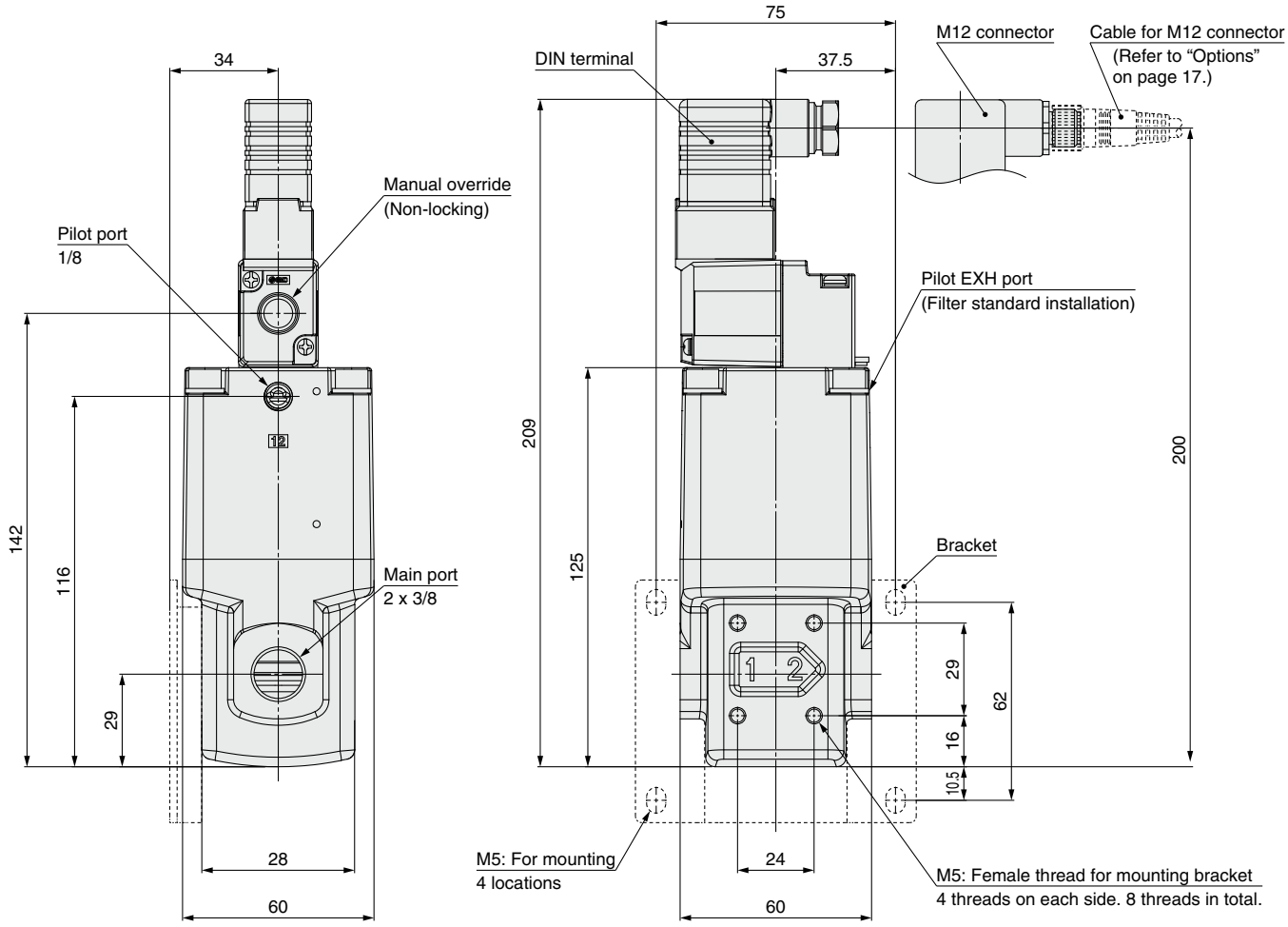

SGH Series

Dimensions: 3-Port, 3 MPa/7 MPa

Air operated type

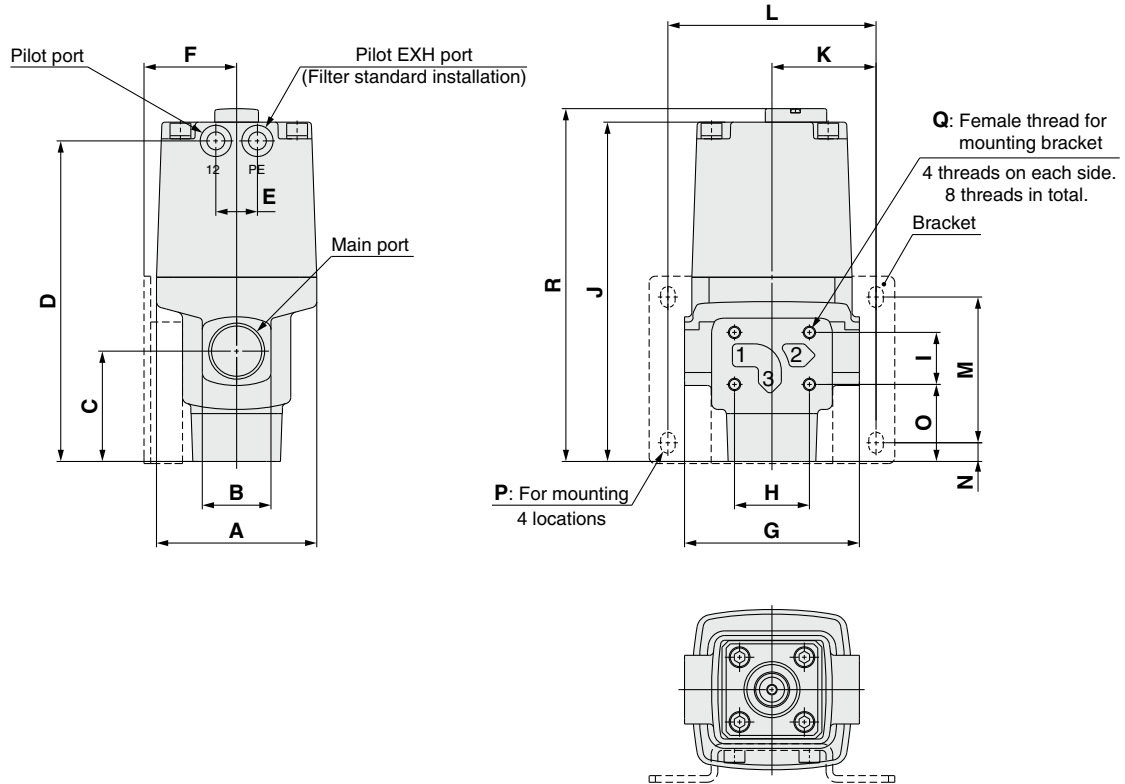

Air Operated Type

Model	Main port	Pilot port	A	B	C	D	E	F	G	H	I	J	K	L	M	N	O
SGHA130-□□10	3 x 3/8	1/8	60	28	46	133	—	34	60	24	29	142	37.5	75	62	6.5	33
SGHA230-3015	3 x 1/2	1/8	60	28	48	135	—	34	65	24	29	144	37.5	75	62	8.5	35
SGHA230-7015	3 x 1/2	1/8	77	36	49	150	20	44.5	80	36	25	159	50	100	70	5	33
SGHA330-3020	3 x 3/4	1/8	77	36	53	154	20	44.5	84	36	25	163	50	100	70	9	37
SGHA330-7020	3 x 3/4	1/4	96	43	60	163	24	60.5	100	49	34	175	63	126	92	0.5	40
SGHA430-3025	3 x 1	1/4	96	43	64.5	167.5	24	60.5	104	49	34	179.5	63	126	92	5	44.5
SGHA430-7025	3 x 1	1/4	113	48	65.5	171.5	24	66.5	115	56	38	183.5	70.5	141	109	—	41.5

Model	P	Q	R
SGHA130-□□10	For M5	M5	148.5
SGHA230-3015	For M5	M5	150.5
SGHA230-7015	For M6	M6	165.5
SGHA330-3020	For M6	M6	169.5
SGHA330-7020	For M8	M8	181.5
SGHA430-3025	For M8	M8	186
SGHA430-7025	For M8	M8	190

Dimensions: 3-Port, 3 MPa/7 MPa

External pilot solenoid type

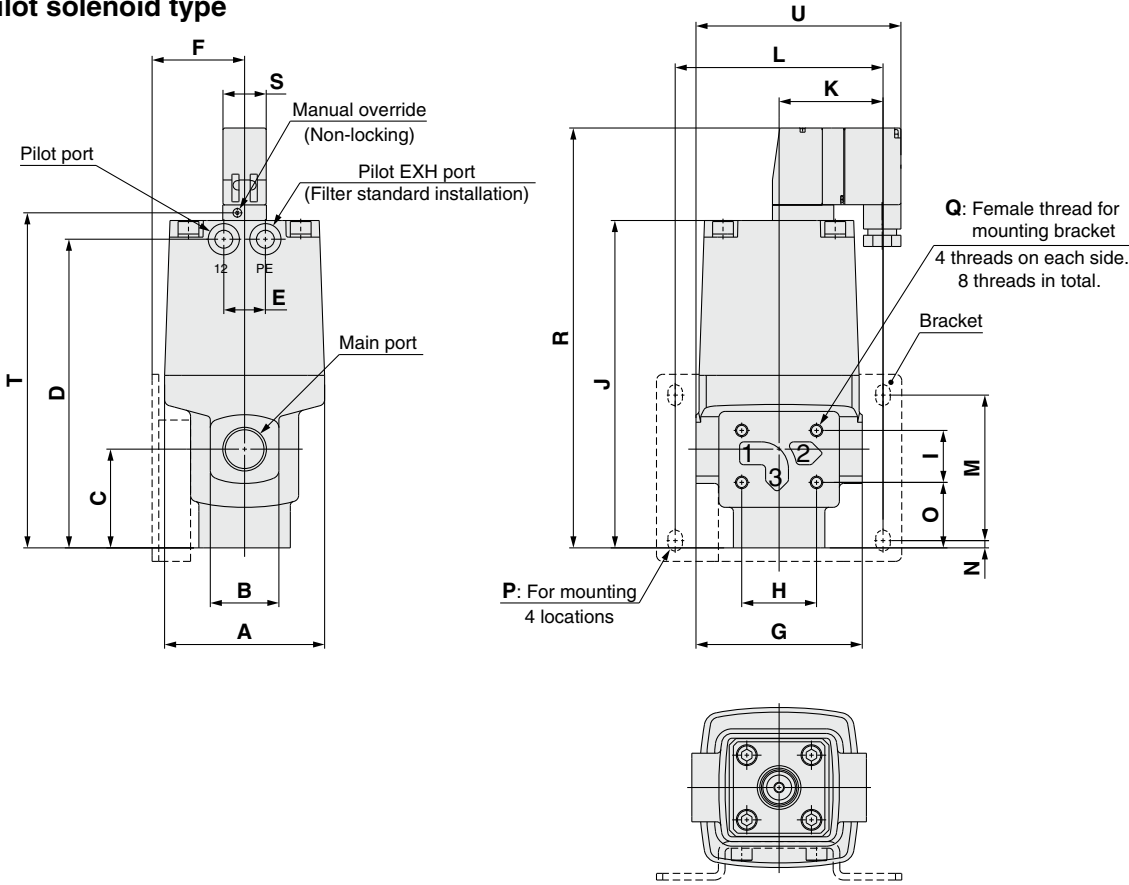

* Drawing indicates conduit terminal type.

External Pilot Solenoid Type (Conduit terminal)

Model	Main port	Pilot port	A	B	C	D	E	F	G	H	I	J	K	L	M	N	O
SGH130-□□10	3 x 3/8	1/8	60	28	46	133	—	34	60	24	29	142	37.5	75	62	6.5	33
SGH230-3015	3 x 1/2	1/8	60	28	48	135	—	34	65	24	29	144	37.5	75	62	8.5	35
SGH230-7015	3 x 1/2	1/8	77	36	49	150	20	44.5	80	36	25	159	50	100	70	5	33
SGH330-3020	3 x 3/4	1/8	77	36	53	154	20	44.5	84	36	25	163	50	100	70	9	37
SGH330-7020	3 x 3/4	1/4	96	43	60	163	24	60.5	100	49	34	175	63	126	92	0.5	40
SGH430-3025	3 x 1	1/4	96	43	64.5	167.5	24	60.5	104	49	34	179.5	63	126	92	5	44.5
SGH430-7025	3 x 1	1/4	113	48	65.5	171.5	24	66.5	115	56	38	183.5	70.5	141	109	—	41.5

Model	P	Q	R	S	T	U
SGH130-□□10	For M5	M5	186.5	20.8	145.7	81.1
SGH230-3015	For M5	M5	188.5	20.8	147.7	83.6
SGH230-7015	For M6	M6	203.5	20.8	162.7	98.6
SGH330-3020	For M6	M6	207.5	20.8	166.7	100.6
SGH330-7020	For M8	M8	219.5	20.8	178.7	117.6
SGH430-3025	For M8	M8	224	20.8	183.2	119.6
SGH430-7025	For M8	M8	228	20.8	187.2	133.6

External Pilot Solenoid Type DIN terminal (DIN terminal)

Model	U
SGH130-□□10	86.8
SGH230-3015	89.3
SGH230-7015	104.3
SGH330-3020	106.3
SGH330-7020	123.3
SGH430-3025	125.3
SGH430-7025	139.3

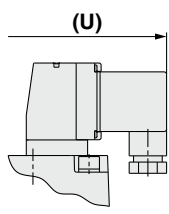

External Pilot Solenoid Type M12 connector (M12 connector)

Model	U
SGH130-□□10	86.8
SGH230-3015	89.3
SGH230-7015	104.3
SGH330-3020	106.3
SGH330-7020	123.3
SGH430-3025	125.3
SGH430-7025	139.3

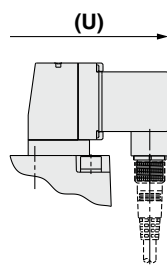

Dimensions: 3-Port, 3 MPa/7 MPa, Dual Pressure Type

Air operated type * The flow direction of the fluid is not the same as the arrow on the body.

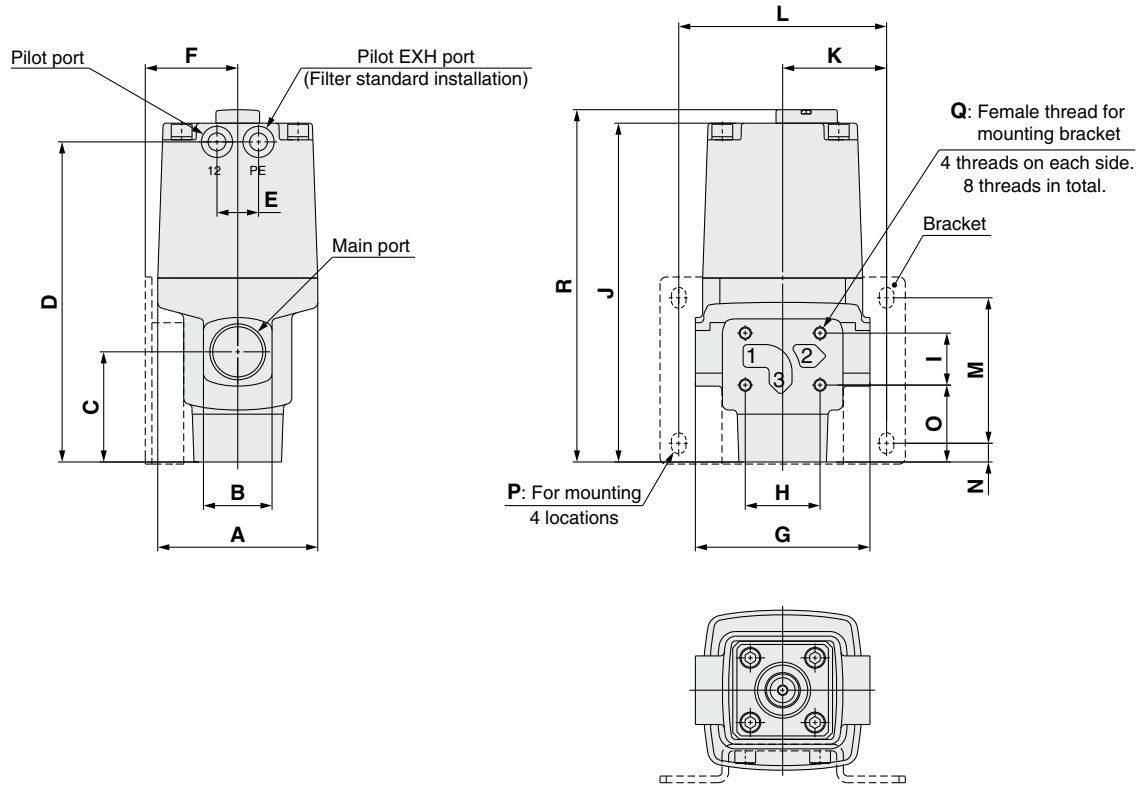

Air Operated Type

Model	Main port	Pilot port	A	B	C	D	E	F	G	H	I	J	K	L	M	N	O
SGHA133-□□□10	3 x 3/8	1/8	60	28	46	133	—	34	60	24	29	142	37.5	75	62	6.5	33
SGHA233-3015	3 x 1/2	1/8	60	28	48	135	—	34	65	24	29	144	37.5	75	62	8.5	35
SGHA233-7015	3 x 1/2	1/8	77	36	49	150	20	44.5	80	36	25	159	50	100	70	5	33
SGHA333-3020	3 x 3/4	1/8	77	36	53	154	20	44.5	84	36	25	163	50	100	70	9	37
SGHA333-7020	3 x 3/4	1/4	96	43	60	178	24	60.5	100	49	34	190	63	126	92	0.5	40
SGHA433-3025	3 x 1	1/4	96	43	64.5	182.5	24	60.5	104	49	34	194.5	63	126	92	5	44.5
SGHA433-7025	3 x 1	1/4	113	48	65.5	195.5	24	66.5	115	56	38	207.5	70.5	141	109	—	41.5

Model	P	Q	R
SGHA133-□□□10	For M5	M5	148.5
SGHA233-3015	For M5	M5	150.5
SGHA233-7015	For M6	M6	165.5
SGHA333-3020	For M6	M6	169.5
SGHA333-7020	For M8	M8	196.5
SGHA433-3025	For M8	M8	201
SGHA433-7025	For M8	M8	214

Dimensions: 3-Port, 3 MPa/7 MPa, Dual Pressure Type

External pilot solenoid type * The flow direction of the fluid is not the same as the arrow on the body.

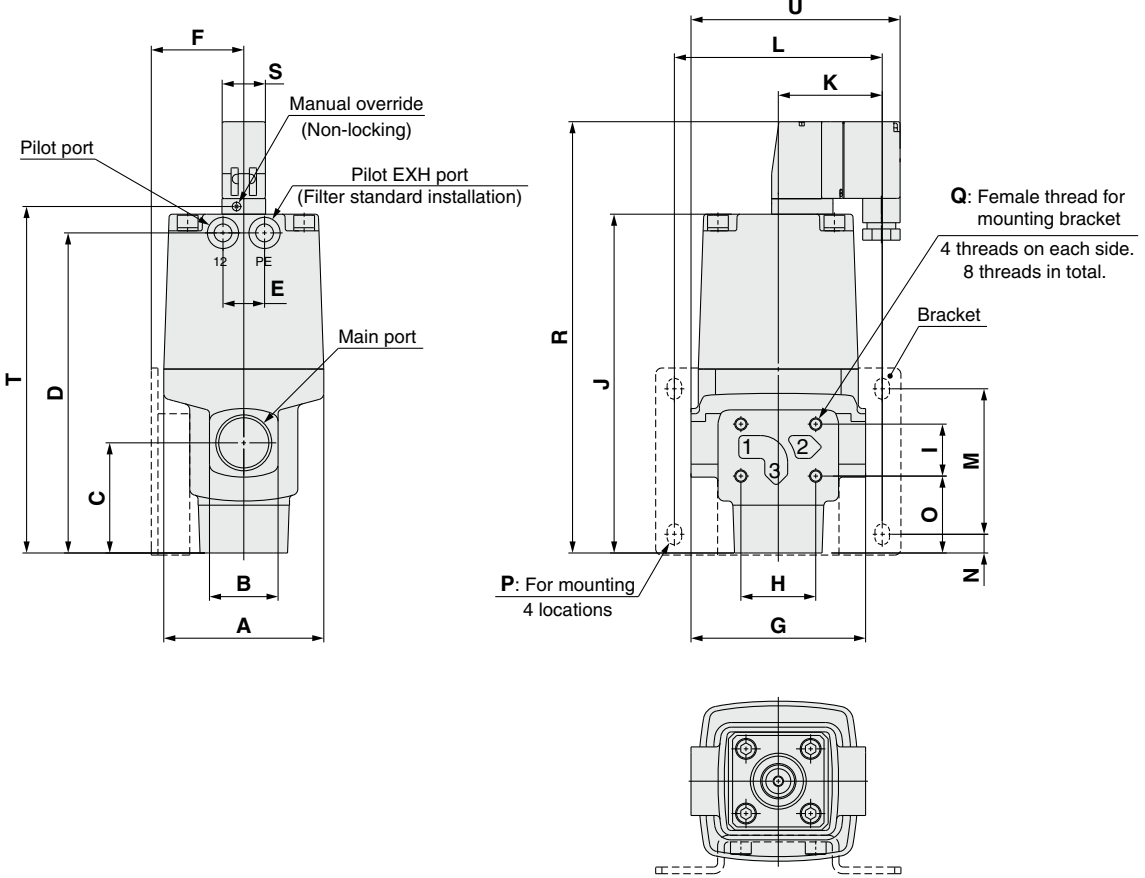

* Drawing indicates conduit terminal type.

External Pilot Solenoid Type (Conduit terminal)

Model	Main port	Pilot port	A	B	C	D	E	F	G	H	I	J	K	L	M	N	O
SGH133-□□10	3 x 3/8	1/8	60	28	46	133	—	34	60	24	29	142	37.5	75	62	6.5	33
SGH233-3015	3 x 1/2	1/8	60	28	48	135	—	34	65	24	29	144	37.5	75	62	8.5	35
SGH233-7015	3 x 1/2	1/8	77	36	49	150	20	44.5	80	36	25	159	50	100	70	5	33
SGH333-3020	3 x 3/4	1/8	77	36	53	154	20	44.5	84	36	25	163	50	100	70	9	37
SGH333-7020	3 x 3/4	1/4	96	43	60	178	24	60.5	100	49	34	190	63	126	92	0.5	40
SGH433-3025	3 x 1	1/4	96	43	64.5	182.5	24	60.5	104	49	34	194.5	63	126	92	5	44.5
SGH433-7025	3 x 1	1/4	113	48	65.5	195.5	24	66.5	115	56	38	207.5	70.5	141	109	—	41.5

Model	P	Q	R	S	T	U
SGH133-□□10	For M5	M5	186.5	20.8	145.7	81.1
SGH233-3015	For M5	M5	188.5	20.8	147.7	83.6
SGH233-7015	For M6	M6	203.5	20.8	162.7	98.6
SGH333-3020	For M6	M6	207.5	20.8	166.7	100.6
SGH333-7020	For M8	M8	234.5	20.8	193.7	117.6
SGH433-3025	For M8	M8	239	20.8	198.2	119.6
SGH433-7025	For M8	M8	252	20.8	211.2	133.6

External Pilot Solenoid Type DIN terminal (DIN terminal)

Model	U
SGH133-□□10	86.8
SGH233-3015	89.3
SGH233-7015	104.3
SGH333-3020	106.3
SGH333-7020	123.3
SGH433-3025	125.3
SGH433-7025	139.3

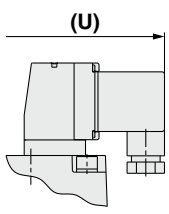

External Pilot Solenoid Type M12 connector (M12 connector)

Model	U
SGH133-□□10	86.8
SGH233-3015	89.3
SGH233-7015	104.3
SGH333-3020	106.3
SGH333-7020	123.3
SGH433-3025	125.3
SGH433-7025	139.3

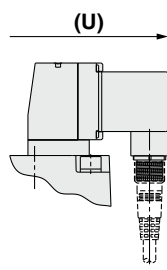

SGH Series Options

Cable for M12 connector (Female connector with cable)

V100-200-**1**-**4**

Specifications

4-pin type	1	DC
	2	AC
5-pin type	3	DC

* When selecting the 5-pin type, only DC voltage can be selected.

Cable length (L)

4	1000 [mm]
8	3000 [mm]
9	5000 [mm]

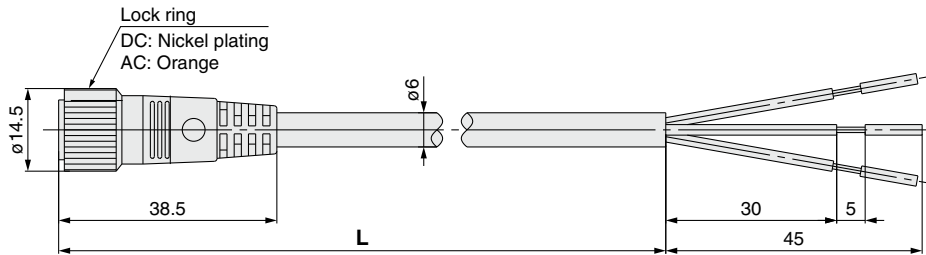

4-pin type

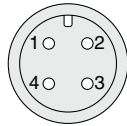

Socket pin connector
pin arrangement

Terminal no.

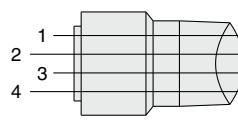

Connections

Cable colors

Cable cover colors for core wire

BROWN: Ground
WHITE: Not used
BLUE: Power supply for valve
BLACK: Power supply for valve

5-pin type

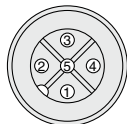

Socket pin connector
pin arrangement

Terminal no.

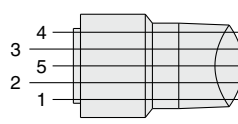

Connections

Cable colors

Cable cover colors for core wire

BLACK: Power supply for valve
BLUE: Power supply for valve
GRAY: Ground
WHITE: Not used
WHITE: Not used

How to Order

Include the part number of the female connector with cable together with the part number for the solenoid valve.

Example) In case of lead wire length, 1000 mm

W: M12 connector (4-pin type)

· DC
SGH221A-7015Y-5WZ
V100-200-1-4

· AC
SGH221A-7015Y-1WZ
V100-200-2-4

V: M12 connector (5-pin type)

SGH221A-7015Y-5VZ
V100-200-3-4

* When selecting the 5-pin type, only DC voltage can be selected.

SGH Series (Common for 2-Port and 3-Port)

Made to Order

Please contact SMC for detailed dimensions, specifications, and lead times.



Connector entry direction selection

SGH **1** ²/₃ **1** **A** - **70** **G** **10** **Y** - **1** **T** **Z** - **B1** - **A**

① to ⑫ are the same as standard. Refer to pages 3 to 5.

Connector entry direction*2

Connector entry direction
<A>

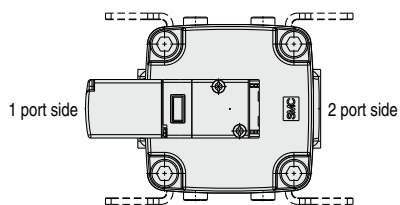

Connector entry direction

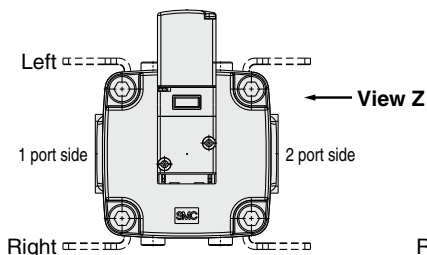

Connector entry direction
<C>

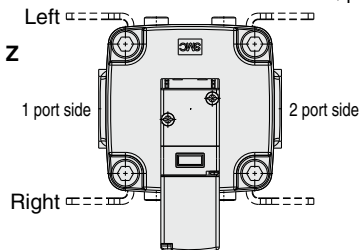

A	1 port side
B*1	Left side mounting
C*1	Right side mounting

*1 Mounting direction (R or L) is viewed from the inlet (1) port.

View Z

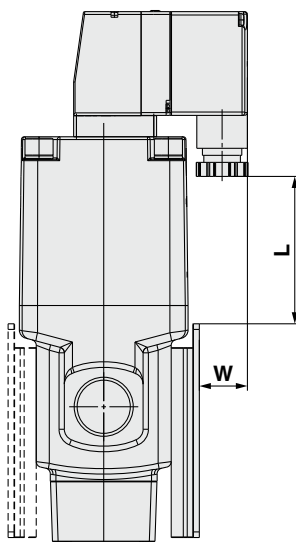

*2 When using a bracket whose direction is the same as that of the pilot valve, ensure that the installation surface does not get in the way of the pilot valve.

Series	Product specifications			T: Conduit terminal		D/DO: DIN terminal		W/V: M12 connector	
				L	W	L	W	L	W
SGH100	2-port	7 MPa	N.C.	52	17	56	22	54	22
			N.O.						
	3-port	3 MPa							
		7 MPa							
3-port dual pressure type	3 MPa	N.C.							
		N.O.							
	7 MPa	3 MPa							
		7 MPa							
SGH200	2-port	7 MPa	N.C.	59	14	63	19	61	19
			N.O.						
	3-port	3 MPa	52	17	56	22	54	22	
		7 MPa	59	14	63	19	61	19	
	3-port dual pressure type	3 MPa	N.C.	52	17	56	22	54	22
			N.O.	59	14	63	19	61	19
		7 MPa	3 MPa	52	17	56	22	54	22
			7 MPa	59	14	63	19	61	19
SGH300	2-port	7 MPa	N.C.	71	7	75	12	73	12
			N.O.						
	3-port	3 MPa	59	14	63	19	61	19	
		7 MPa	56	7	60	12	58	12	
	3-port dual pressure type	3 MPa	N.C.	59	14	63	19	61	19
			N.O.	71	7	75	12	73	12
		7 MPa	3 MPa	59	14	63	19	61	19
			7 MPa	71	7	75	12	73	12
SGH400	2-port	7 MPa	N.C.	79	9	83	15	81	15
			N.O.						
	3-port	3 MPa	56	7	60	12	58	12	
		7 MPa							
	3-port dual pressure type	3 MPa	55	9	59	15	57	15	
		7 MPa							79



SGH Series Specific Product Precautions 1

Be sure to read this before handling the products. Refer to the back cover for safety instructions. For 2-port solenoid valve for fluid control precautions, refer to the “Handling Precautions for SMC Products” and the “Operation Manual” on the SMC website: <https://www.smcworld.com>

Design

⚠ Warning

Extended periods of continuous energization

If a valve is continuously energized for long periods of time, heat generation of the coil may result in reduced performance and shorter service life. This may also have an adverse effect on the peripheral equipment in proximity. Should a valve be continuously energized for long periods of time, or its daily energized state exceeds its non-energized state, please use a valve with DC specifications. Additionally, when using with AC, energizing for long periods of time continuously, select the air-operated valve and use the continuous duty type of the VT307 for a pilot valve.

Fluid Quality

⚠ Warning

Although the product has a scraper to prevent foreign matter from entering into the product, fluid containing fine foreign matter such as abrasive powder may cause sealing failure by the foreign matter adhering to the rod sliding part.

Perform periodic maintenance or take countermeasures. Sealing failure of the rod sliding surface will allow reverse flow of the fluid in the pilot air piping, entering into the pilot valve or circuit connected to the pilot air piping, causing adverse effects such as operation failure or leakage.

Mounting

⚠ Warning

- 1. Do not apply external force to the coil section.**
When tightening is performed, apply a wrench or other tool to the outside of the piping connection ports.
- 2. Do not warm the coil assembly with a heat insulator, etc.**
Use tape, heaters, etc., for freeze prevention on the piping and body only. This can cause the coil to burn out.
- 3. Avoid sources of vibration, or adjust the arm from the body to the minimum length so that resonance will not occur.**
- 4. Avoid mounting the valve vertically facing downwards, otherwise, foreign matter in the coolant will accumulate in the plate assembly which may shorten the product's life.**

Manual Override

⚠ Warning

Since connected equipment will be actuated when the manual override is operated, first confirm that conditions are safe.

■ Non-locking push type

Press in the direction of the arrow.

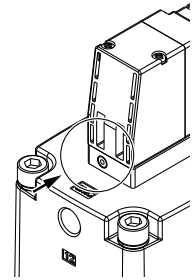

■ Push-turn locking slotted type [D type]

While pressing, turn in the direction of the arrow (90° clockwise). If it is not turned, it can be operated the same way as the non-locking type.

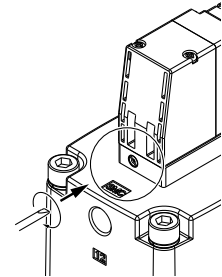

⚠ Caution

When operating the push-turn locking slotted type (D) with a screwdriver, turn it gently using a flat head watchmaker's screwdriver. [Torque: Less than 0.1 N·m]

When locking the manual override on the push-turn locking slotted type (D), be sure to push it down before turning. Turning without first pushing it down can cause damage to the manual override and trouble such as air leakage, etc.



SGH Series

Specific Product Precautions 2

Be sure to read this before handling the products. Refer to the back cover for safety instructions. For 2-port solenoid valve for fluid control precautions, refer to the “Handling Precautions for SMC Products” and the “Operation Manual” on the SMC website: <https://www.smcworld.com>

Wiring

⚠ Caution

1. Applied voltage

When electric power is connected to a solenoid valve, be careful to apply the proper voltage. Failure to do so may result in malfunction or coil damage.

2. Check the connections.

Check that the connections are correct after completing all wiring.

Leakage Voltage

⚠ Caution

Take note that the leakage voltage will increase when a resistor is used in parallel with a switching element or when a C-R circuit (surge voltage suppressor) is used for protecting a switching device because of the leakage voltage passing through the C-R circuit. The suppressor residual leakage voltage should be as follows.

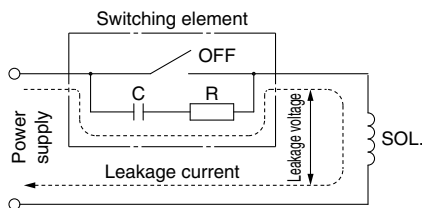

DC coil

3% or less of the rated voltage

AC coil

8% or less of the rated voltage (For the 0.35 W type: Pilot valve V116)

15% or less of the rated voltage (For the 1.8 W type: Pilot valve VO307)

Operating Environment

⚠ Caution

1. Products with an IP65 enclosure (based on IEC60529) are protected against dust and water. However, these products cannot be used in water.

2. If the product is used in an environment where condensation is generated, there may be a risk of rusting.

Maintenance

⚠ Warning

Do not disassemble the product. The safety of products which have been disassembled cannot be guaranteed. In particular, the C type retaining ring inside the cover of the N.C. type valve and the bolt on the cover of the 3-port dual pressure specification must not be removed. Removal may result in the cover, piston, or spring popping out, which may result in an accident. Never remove the C type retaining ring or the bolt.



SGH Series

Specific Product Precautions 3

Be sure to read this before handling the products. Refer to the back cover for safety instructions. For 2-port solenoid valve for fluid control precautions, refer to the "Handling Precautions for SMC Products" and the "Operation Manual" on the SMC website: <https://www.smcworld.com>

Precautions on Pilot Valve V116

Light/Surge Voltage Suppressor

⚠ Caution

<DC>

Conduit terminal (Non-polar)

Surge voltage suppressor (TS)

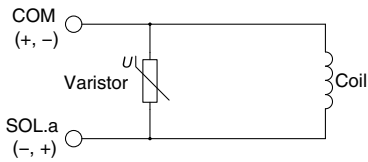

Light/surge voltage suppressor (TZ)

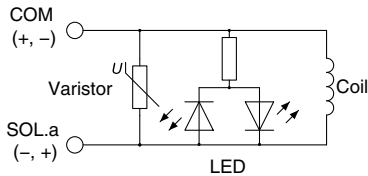

DIN terminal (Non-polar)

Surge voltage suppressor (DS)

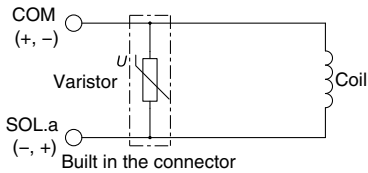

Light/surge voltage suppressor (DZ)

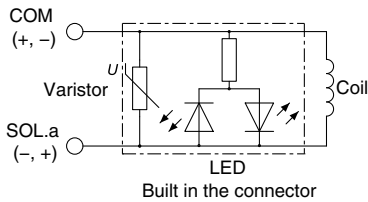

M12 connector (Non-polar)

Surge voltage suppressor (WS/VS)

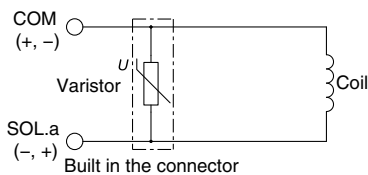

Light/surge voltage suppressor (WZ/VZ)

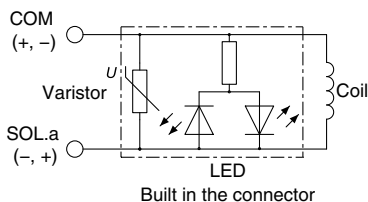

<AC>

Conduit terminal

Surge voltage suppressor (TS)

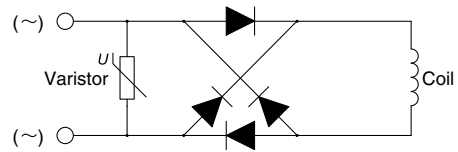

Light/surge voltage suppressor (TZ)

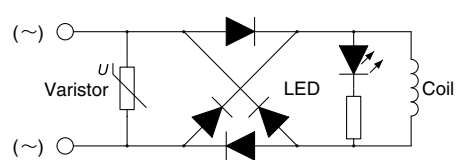

DIN terminal

Surge voltage suppressor (DS)

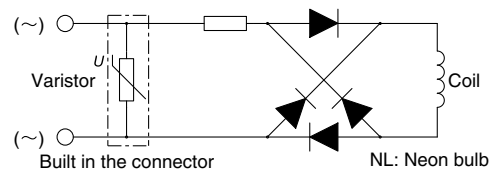

Light/surge voltage suppressor (DZ)

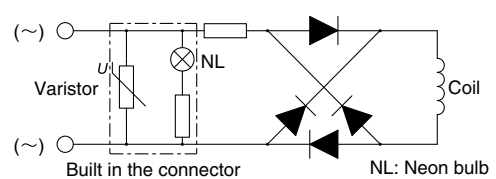

M12 connector

Surge voltage suppressor (WS)

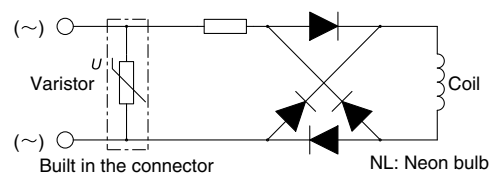

Light/surge voltage suppressor (WZ)

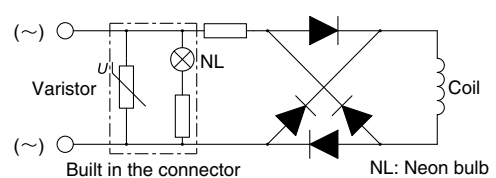



SGH Series Specific Product Precautions 4

Be sure to read this before handling the products. Refer to the back cover for safety instructions. For 2-port solenoid valve for fluid control precautions, refer to the “Handling Precautions for SMC Products” and the “Operation Manual” on the SMC website: <https://www.smcworld.com>

M12 Connector

⚠ Caution

1. M12 connector types of the pilot valve V116 have an IP65 (enclosure) rating, offering protection from dust and water. However, please note: these products are not intended for use in water.
2. Do not use a tool to mount the connector, as this may cause damage. Only tighten by hand. (0.4 to 0.6 N·m)
3. The excessive stress on the cable connector will not be able to satisfy the IP65 rating. Please use caution and do not apply a stress of 30 N or greater.

Take note that if a connector other than the one stated above is used or if the connector is not tight enough, the IP65 rating will not be satisfied.

M12 connector

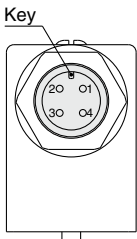

Female connector with cable

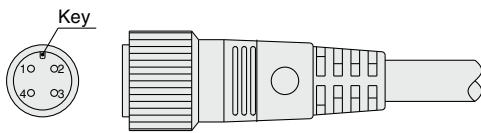

* For connecting a female connector with cable, adjust the connector key to the M12 connector key in the valve side since there is an orientation. Be careful not to squeeze it in the wrong direction, as problems such as pin damage may occur.

■ Pin assignment of M12 connector on valve side

4-pin type

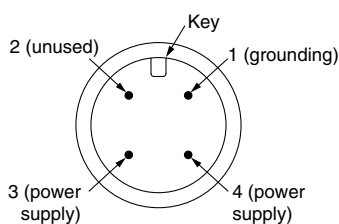

5-pin type

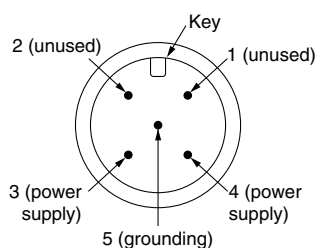

4-pin type		5-pin type	
DC	AC	DC	AC
●*2	●*1	●*2	—

*1 For AC, a surge voltage suppressor or light/surge voltage suppressor can be selected.

*2 About DC specifications
0.35 W type (Pilot valve V116) has no polarity.
1.8 W type (Pilot valve VO307) has the polarity, pin no. 3 (–) and pin no. 4 (+).

How to Use Conduit Terminal

⚠ Caution

Connection procedures

1. Loosen the holding screw and remove the cover from the terminal block.
2. Loosen the terminal screw in the terminal block. Insert the lead core wires or crimped terminals to the terminals, and secure the wires by re-tightening the terminal screw.
3. Secure the cord by fastening the ground nut.

When making connections, take note that using other than the supported size (ø4.5 to ø7) heavy-duty cord will not satisfy IP65 (enclosure) standards. Also, be sure to tighten the ground nut and holding screw within their specified torque ranges.

Compatible cable

Cord O.D.: ø4.5 to ø7

(Reference) 0.5 to 1.5 mm², 2-core or 3-core, equivalent to JIS C 3306

Applicable crimped terminals

O-terminals: Equivalent to R1.25-3 defined in the JIS C2805

Y-terminals: Equivalent to 1.25-3 manufactured by J.S.T. Mfg. Co., Ltd.

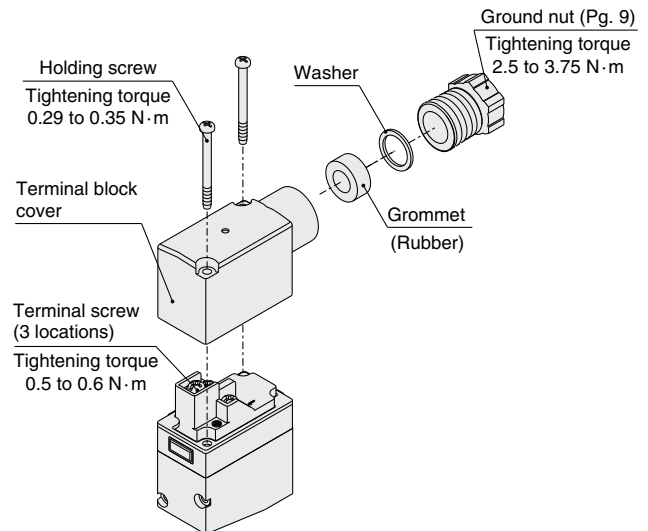



SGH Series Specific Product Precautions 5

Be sure to read this before handling the products. Refer to the back cover for safety instructions. For 2-port solenoid valve for fluid control precautions, refer to the “Handling Precautions for SMC Products” and the “Operation Manual” on the SMC website: <https://www.smcworld.com>

Precautions on Pilot Valve V116

How to Use DIN Terminal

Caution

Connection procedures

1. Loosen the holding screw and pull the connector out of the solenoid valve terminal block.
2. After removing the holding screw, insert a flat head screwdriver, etc. into the notch on the bottom of the terminal block and pry it open, separating the terminal block and the housing.
3. Loosen the terminal screw (slotted screws) in the terminal block. Insert the lead core wires or crimped terminals to the terminals according to the connection method, and secure the wires by re-tightening the terminal screw.
4. Secure the cord by fastening the ground nut.

When making connections, take note that using other than the supported size ($\phi 4.5$ to $\phi 7$) heavy-duty cord will not satisfy IP65 (enclosure) standards. Also, be sure to tighten the ground nut and holding screw within their specified torque ranges.

Changing the entry direction

After separating the terminal block and housing, the cord entry can be changed by attaching the housing in the opposite direction 180°.

* Be careful not to damage the element, etc. with the cord's lead wires.

Plug in and pull out the connector vertically without tilting to one side.

Compatible cable

Cord O.D.: $\phi 4.5$ to $\phi 7$

(Reference) 0.5 to 1.5 mm², 2-core or 3-core, equivalent to JIS C 3306

Applicable crimped terminals

O-terminals: Up to R1.25-4M defined in the JIS C2805

Y-terminals: Up to R1.25-3L manufactured by J.S.T. Mfg. Co., Ltd.

Rod-terminals: Up to size 1.5

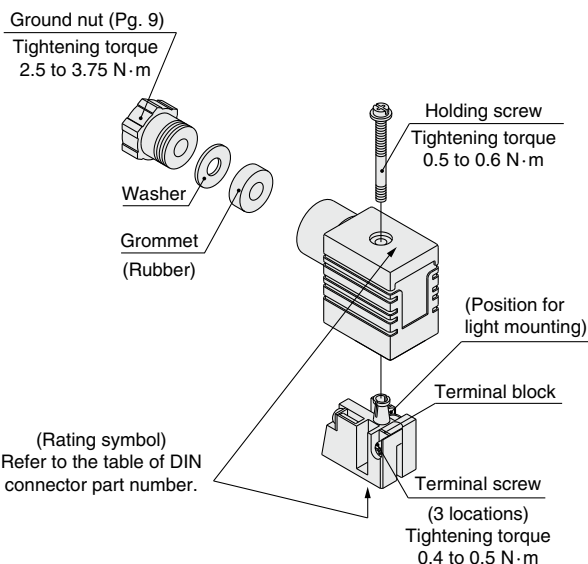

DIN Terminal Connector Part No.

DIN Connector Part No.

Without light	DC only	V100-61-1
---------------	---------	-----------

With Surge Voltage Suppressor

Rated voltage	Rating symbol	Part no.
24 VDC	DC 24 VS	V100-61-5-05
12 VDC	DC 12 VS	V100-61-5-06
100 VAC	100/110 VS	V100-61-4-01
200 VAC	200/220 VS	V100-61-4-02
110 VAC	100/110 VS	V100-61-4-01
220 VAC	200/220 VS	V100-61-4-02
240 VAC	240 VS	V100-61-4-07

With Light/Surge Voltage Suppressor

Rated voltage	Rating symbol	Part no.
24 VDC	DC 24 VZ	V100-61-3-05
12 VDC	DC 12 VZ	V100-61-3-06
100 VAC	100/110 VZ	V100-61-2-01
200 VAC	200/220 VZ	V100-61-2-02
110 VAC	100/110 VZ	V100-61-2-01
220 VAC	200/220 VZ	V100-61-2-02
240 VAC	240 VZ	V100-61-2-07

* If an AC specification without a DIN terminal (DO) is selected, use a DIN connector with a surge voltage suppressor as the connector.

Pitch between terminals of the DIN terminal

Refer to the drawing below for the pitch between terminals of the DIN terminal.

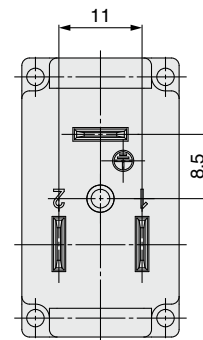

Circuit Diagram with Light/Surge Voltage Suppressor

AC circuit diagram

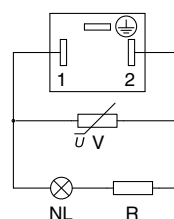

NL: Neon light, R: Resistor
V: Varistor

DC circuit diagram

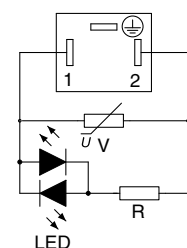

LED: Light emitting diode, R: Resistor
V: Varistor



SGH Series Specific Product Precautions 6

Be sure to read this before handling the products. Refer to the back cover for safety instructions. For 2-port solenoid valve for fluid control precautions, refer to the “Handling Precautions for SMC Products” and the “Operation Manual” on the SMC website: <https://www.smcworld.com>

Precautions on Pilot Valve VO307

How to Use DIN Terminal

Disassembly

- Loosen screw ① and pull up housing ② in the direction of screw ① to remove the connector from the body (solenoid).
- Pull out screw ① from housing ②.
- On the bottom part of terminal block ③, there is a notch ⑨. If a small flat blade screwdriver is inserted into the gap between housing ② and terminal block ③, terminal block ③ will be removed from housing ②. (Refer to the figure below.)
- Remove cable gland ④, washer ⑤ and rubber seal ⑥.

Wiring

- Insert cable gland ④, washer ⑤ and rubber seal ⑥ into cable ⑦ in order, and insert it into housing ②.
- Loosen screws ⑩ on terminal block ③. Insert lead wires ⑩ and tighten screws ⑩ again.
 - The tightening torque should be 0.5 N·m \pm 15%.
 - The applicable outside diameter of cable ⑦ is ϕ 6 to ϕ 8 mm.
 - Round or Y-shaped crimped terminal cannot be used.

Assembly

- Insert cable gland ④, washer ⑤ and rubber seal ⑥ and housing ② into cable ⑦ in order. Connect cable ⑦ to terminal block ③ and fix terminal block ③ to housing ② in place. Insert the terminal block until it makes a click sound.
- Insert rubber seal ⑥ and washer ⑤ into the cable entry on housing ② in order, and tighten cable gland ④ securely.
- Insert gasket ⑧ into the gap between the bottom of terminal block ③ and plug on the equipment, and insert screw ① from the top of housing ② to tighten them.
 - The tightening torque should be 0.5 N·m \pm 20%.
 - The orientation of the connector can be changed by 180 degrees depending on the mounting direction of housing ② and terminal block ③.

DIN Terminal Connector Replacement Parts

Description	Part no.
DIN connector	GM209NJ-B17 (CE/UKCA-compliant)
DIN gasket	CAXT623-6-7-11 (CE/UKCA-compliant)

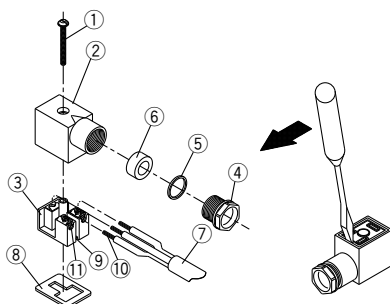

Light/Surge Voltage Suppressor

Caution

AC

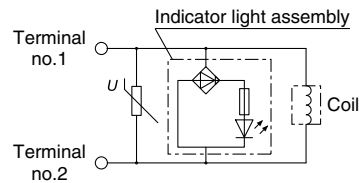

DC

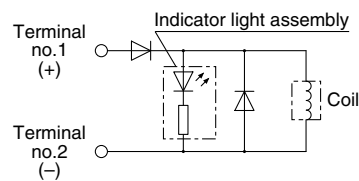

Electrical Wiring

Caution

The DIN connector terminal and conduit terminal (with indicator light/surge voltage suppressor) are wired internally as shown below. Connect each terminal to the corresponding wire of the power supply.

DIN terminal block

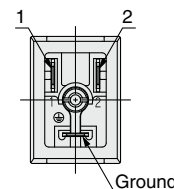

Terminal no.	1	2
DIN terminal	+	-

- Applicable cord O.D.
- D type: ϕ 6 to ϕ 8

Lead Wire Color

Voltage	Color
100 VAC	Blue
200 VAC	Red
DC	Red (+), Black (-)
Other	Gray

Pitch between terminals of the DIN terminal

Refer to the drawing below for the pitch between terminals of the DIN terminal.

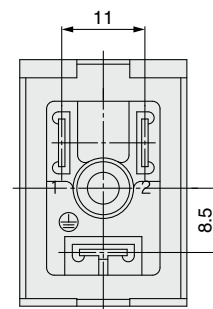

Safety Instructions

These safety instructions are intended to prevent hazardous situations and/or equipment damage. These instructions indicate the level of potential hazard with the labels of “**Caution**,” “**Warning**” or “**Danger**.” They are all important notes for safety and must be followed in addition to International Standards (ISO/IEC)*1), and other safety regulations.

 **Caution:** **Caution** indicates a hazard with a low level of risk which, if not avoided, could result in minor or moderate injury.

 **Warning:** **Warning** indicates a hazard with a medium level of risk which, if not avoided, could result in death or serious injury.

 **Danger :** **Danger** indicates a hazard with a high level of risk which, if not avoided, will result in death or serious injury.

*1) ISO 4414: Pneumatic fluid power – General rules relating to systems.
ISO 4413: Hydraulic fluid power – General rules relating to systems.
IEC 60204-1: Safety of machinery – Electrical equipment of machines.
(Part 1: General requirements)
ISO 10218-1: Manipulating industrial robots – Safety.
etc.

Warning

1. The compatibility of the product is the responsibility of the person who designs the equipment or decides its specifications.

Since the product specified here is used under various operating conditions, its compatibility with specific equipment must be decided by the person who designs the equipment or decides its specifications based on necessary analysis and test results. The expected performance and safety assurance of the equipment will be the responsibility of the person who has determined its compatibility with the product. This person should also continuously review all specifications of the product referring to its latest catalog information, with a view to giving due consideration to any possibility of equipment failure when configuring the equipment.

2. Only personnel with appropriate training should operate machinery and equipment.

The product specified here may become unsafe if handled incorrectly. The assembly, operation and maintenance of machines or equipment including our products must be performed by an operator who is appropriately trained and experienced.

3. Do not service or attempt to remove product and machinery/equipment until safety is confirmed.

1. The inspection and maintenance of machinery/equipment should only be performed after measures to prevent falling or runaway of the driven objects have been confirmed.
2. When the product is to be removed, confirm that the safety measures as mentioned above are implemented and the power from any appropriate source is cut, and read and understand the specific product precautions of all relevant products carefully.
3. Before machinery/equipment is restarted, take measures to prevent unexpected operation and malfunction.

4. Contact SMC beforehand and take special consideration of safety measures if the product is to be used in any of the following conditions.

1. Conditions and environments outside of the given specifications, or use outdoors or in a place exposed to direct sunlight.
2. Installation on equipment in conjunction with atomic energy, railways, air navigation, space, shipping, vehicles, military, medical treatment, combustion and recreation, or equipment in contact with food and beverages, emergency stop circuits, clutch and brake circuits in press applications, safety equipment or other applications unsuitable for the standard specifications described in the product catalog.
3. An application which could have negative effects on people, property, or animals requiring special safety analysis.
4. Use in an interlock circuit, which requires the provision of double interlock for possible failure by using a mechanical protective function, and periodical checks to confirm proper operation.

Caution

1. The product is provided for use in manufacturing industries.

The product herein described is basically provided for peaceful use in manufacturing industries.
If considering using the product in other industries, consult SMC beforehand and exchange specifications or a contract if necessary.
If anything is unclear, contact your nearest sales branch.

Limited warranty and Disclaimer/ Compliance Requirements

The product used is subject to the following “Limited warranty and Disclaimer” and “Compliance Requirements”.

Read and accept them before using the product.

Limited warranty and Disclaimer

1. The warranty period of the product is 1 year in service or 1.5 years after the product is delivered, whichever is first.*2)
Also, the product may have specified durability, running distance or replacement parts. Please consult your nearest sales branch.
2. For any failure or damage reported within the warranty period which is clearly our responsibility, a replacement product or necessary parts will be provided.
This limited warranty applies only to our product independently, and not to any other damage incurred due to the failure of the product.
3. Prior to using SMC products, please read and understand the warranty terms and disclaimers noted in the specified catalog for the particular products.

*2) Vacuum pads are excluded from this 1 year warranty.

A vacuum pad is a consumable part, so it is warranted for a year after it is delivered.
Also, even within the warranty period, the wear of a product due to the use of the vacuum pad or failure due to the deterioration of rubber material are not covered by the limited warranty.

Compliance Requirements

1. The use of SMC products with production equipment for the manufacture of weapons of mass destruction (WMD) or any other weapon is strictly prohibited.
2. The exports of SMC products or technology from one country to another are governed by the relevant security laws and regulations of the countries involved in the transaction. Prior to the shipment of a SMC product to another country, assure that all local rules governing that export are known and followed.

Caution

SMC products are not intended for use as instruments for legal metrology.

Measurement instruments that SMC manufactures or sells have not been qualified by type approval tests relevant to the metrology (measurement) laws of each country. Therefore, SMC products cannot be used for business or certification ordained by the metrology (measurement) laws of each country.

Revision History

Edition B * 10 and 14 MPa specifications have been added.

* Number of pages has been increased from 24 to 28.

ZW

Safety Instructions

Be sure to read the “Handling Precautions for SMC Products” (M-E03-3) and “Operation Manual” before use.