

SMC eliminates a variety of static electricity generated problems.

The adsorption of multiple sheets

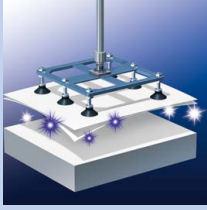

The clogging of parts feeders

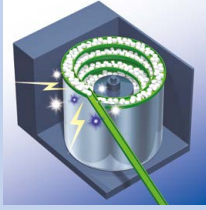

Discomfort due to electric shocks in the workplace

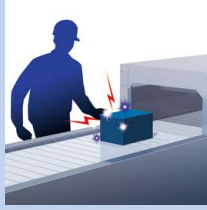

The electrostatic breakdown of substrates and IC chips

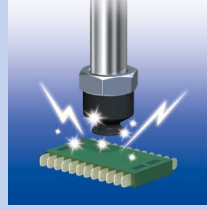

Failure to eject workpieces from unloaders

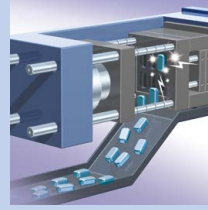

Uneven painting



Ionizers

Bar Type IZS40/41/42 Series



Separate Controller, Bar Type IZT40/41(-L)/42(-L) Series



Separate Controller, Nozzle Type IZT43(-L) Series



Desktop Duster Box ZVB Series



Nozzle Type IZN10E Series



Fan Type IZF Series



Ionizer Gun (Handheld Type) IZG10 Series



Handheld Electrostatic Meter

Handheld Electrostatic Meter IZH10



Electrostatic Sensor/Sensor Monitor

Sensor IZD10



Monitor IZE11

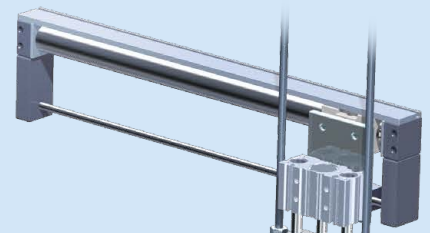

Antistatic Equipment

- Conductive fittings
- Tubing
- Speed controller with One-touch fittings
- Vacuum pad

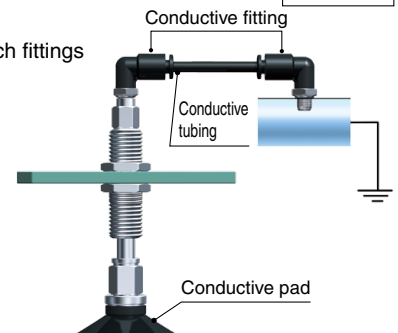

For more information



Static Neutralization Area

* The distance from the target workpiece varies depending on the size, etc., and should be used as a guideline.

Wide

Narrow

● Bar type



IZS40/41/42 Series p. 16

<Separate type>

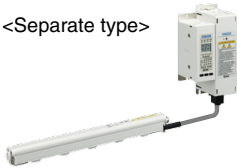

IZT40/41(-L)/42(-L) Series p. 48

The length of the bar can be selected, allowing for a wide range of neutralization.

● Fan type



IZF Series p. 146

The adjustable louver allows for the selection of a wide range of distances.

● Ionizer gun (Handheld type)



IZG10 Series p. 178

● Nozzle type



IZN10E Series p. 118

Various nozzles can be attached to the tip of the main body, allowing for the local static neutralization of narrow sections.

<Separate type>

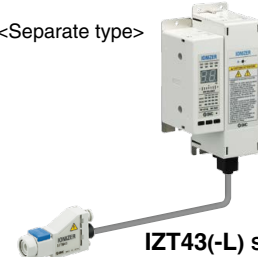

IZT43(-L) Series p. 48

Separate bars and controllers can be used for the static neutralization of narrow sections close to the workpiece.

Workpiece Size (Guide)

* The distance from the target workpiece varies depending on the size, etc., and should be used as a guideline.

Large

Small

● Bar type



IZS40/41/42 Series p. 16

<Separate type>

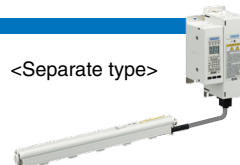

IZT40/41(-L)/42(-L) Series p. 48

● Fan type



IZF Series p. 146

● Nozzle type



IZN10E Series p. 118

● Ionizer gun (Handheld type)



IZG10 Series p. 178

IZT43(-L) Series p. 48

Static Neutralization Method

Potential amplitude reduction specification (Dual AC type)

Potential amplitude:
25 v or less



IZS42 Series p. 16

IZT42(-L) Series p. 48

High-speed static neutralization specification



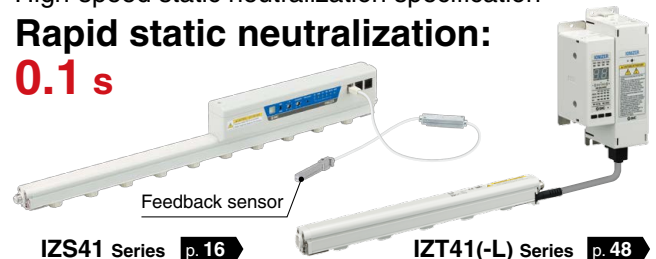





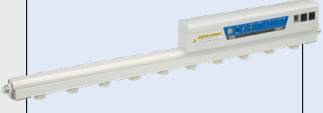
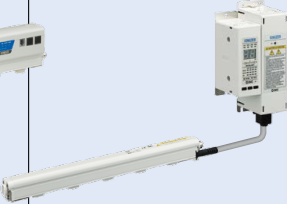

Rapid static neutralization:
0.1 s

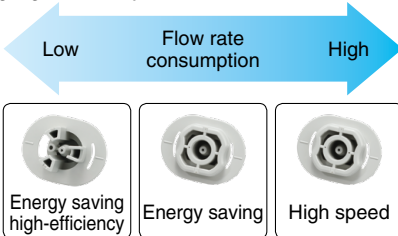

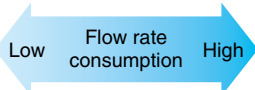

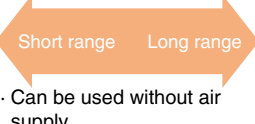
IZS41 Series p. 16

IZT41(-L) Series p. 48

Series Variations

Ionizer type	Bar type		Nozzle type	
	Integrated controller	Separate controller	IO-Link IZT43-L Series	Integrated controller
Series	IZS40/41/42 Series 	IZT40/41/42 Series 	IZT43 Series IO-Link IZT43-L Series 	IZN10E Series 
Method of applying voltage	AC, DC, Dual AC (IZS42)	AC, DC, Dual AC (IZT42(-L))	AC, DC	High frequency AC
Main features	<ul style="list-style-type: none"> Bar length 340 to 2500 mm Emitter cartridge <ul style="list-style-type: none"> Energy saving high-efficiency Energy saving High speed Selectable with or without air supply Potential amplitude reduction (IZS42) Rapid static neutralization (IZS40/41) External sensor connection (IZS41/42) 	<ul style="list-style-type: none"> Bar length 160 to 2500 mm Emitter cartridge <ul style="list-style-type: none"> Energy saving high-efficiency Energy saving High speed Easy insertion and removal of high voltage cables Selectable with or without air supply Potential amplitude reduction (IZT42) Rapid static neutralization (IZT40/41) IO-Link compatible (IZT41-L/42-L) 	<ul style="list-style-type: none"> Compact Selectable with or without air supply Emitter cartridge <ul style="list-style-type: none"> Energy saving High speed Easy insertion and removal of high voltage cables IO-Link compatible 	<ul style="list-style-type: none"> Slim, Compact Easy maintenance due to the easy to attach/detach emitters The nozzle type can be selected according to the application. Air saving rapid static neutralization due to the flow amplifying structure (Energy saving nozzle type)
	<ul style="list-style-type: none"> Low pressure loss design (Pipeable on 1 side) 3 types of emitter cartridges can be selected according to the application: High speed, Energy saving, or Energy saving high-efficiency. <div style="text-align: center;">  </div> <ul style="list-style-type: none"> Can be used without air supply Bar length selectable at 60 mm pitch For reducing the potential amplitude: Dual AC type IZS42/ IZT42(-L) Operation from a distance: Remote control function (IZS41/42) 	<ul style="list-style-type: none"> Space saving (Separate nozzle thickness x Width x Height): 16 x 64 x 32 mm 2 types of nozzles can be selected according to the application: Energy saving nozzle or High flow rate nozzle. <div style="text-align: center;">  </div> <div style="text-align: center;">  </div> <div style="text-align: center;">  </div> <ul style="list-style-type: none"> Can be used without air supply 	<ul style="list-style-type: none"> Space saving (Thickness x Width x Height): 16 x 100 x 46 mm 3 types of nozzles can be selected. <div style="display: flex; justify-content: space-around;">   </div> <div style="display: flex; justify-content: center; margin-top: 10px;">  </div> <ul style="list-style-type: none"> Nozzle variations (8 types): With right angles (Energy saving/High flow rate), Circular diffusion, Flat diffusion, Bar (Straight type), Circumferential jet bar, Bender tube, and Long 	
Subject workpiece size guideline	Small to large		Small	
Painting (Excludes explosion prevention)	○		○	
Rubber/Resin molding	○		○	
Paper/Printing	○		○	
Film	○		○	
Food (Packaging materials)	○		○	
FPD	○		○	
Electronic parts mounting	○		○	
Semiconductor	○		○	

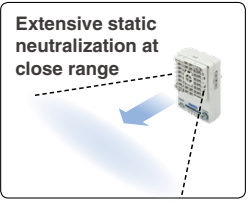
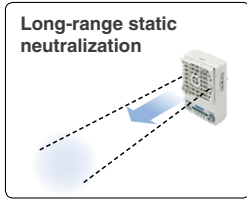
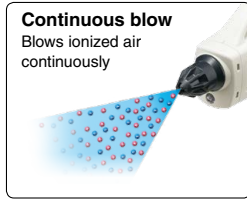
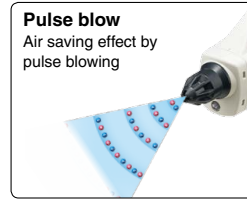

	Fan type	Ionizer gun (Handheld type)
	<p align="center">IZF Series</p> 	<p align="center">IZG10 Series</p> 
	DC	High frequency AC
	<div style="display: flex; flex-direction: column; align-items: center;"> <div style="background-color: #0070C0; color: white; padding: 5px; margin-bottom: 5px;">Slim</div> <div style="background-color: #0070C0; color: white; padding: 5px; margin-bottom: 5px;">Rapid static neutralization</div> <div style="background-color: #0070C0; color: white; padding: 5px;">Automatic cleaning function selectable (IZF21/31)</div> </div>	<div style="display: flex; flex-direction: column; align-items: center;"> <div style="background-color: #0070C0; color: white; padding: 5px; margin-bottom: 5px;">Lightweight</div> <div style="background-color: #0070C0; color: white; padding: 5px; margin-bottom: 5px;">Rapid static neutralization</div> <div style="background-color: #0070C0; color: white; padding: 5px; margin-bottom: 5px;">Air saving*1</div> <div style="font-size: small; margin-bottom: 5px;">*1 For pulse blow</div> <div style="background-color: #0070C0; color: white; padding: 5px;">Emitters can be attached/detached.</div> </div>
	<ul style="list-style-type: none"> · Slim design (Thickness: 40 mm) · Large amount of ions generated, low potential amplitude: DC system adopted · Long service life: Averaging function (IZF21/31) · Reduced maintenance: Automatic cleaning unit (IZF21/31) · Long range static neutralization and extensive static neutralization at close range are possible: Adjustable louver (IZF21/31) <div style="display: flex; justify-content: space-around; margin-top: 10px;"> <div style="border: 1px solid black; padding: 5px; width: 45%;"> <p>Extensive static neutralization at close range</p>  </div> <div style="border: 1px solid black; padding: 5px; width: 45%;"> <p>Long-range static neutralization</p>  </div> </div>	<ul style="list-style-type: none"> · Lightweight: 200 [g] · Illumination of the recessed area: LED lighting · For the numerical control of flow rates: Restrictor with indicator · Reduced worker burden: Trigger lock function · For the numerical control of working hours: Trigger OFF timer · Continuous blow/Pulse blow <div style="display: flex; justify-content: space-around; margin-top: 10px;"> <div style="border: 1px solid black; padding: 5px; width: 45%;"> <p>Continuous blow Blows ionized air continuously</p>  </div> <div style="border: 1px solid black; padding: 5px; width: 45%;"> <p>Pulse blow Air saving effect by pulse blowing</p>  </div> </div>
	Small to medium	Small
	○	○
	◎	○
	○	○
	○	○
	◎	◎
	◎	◎
	◎	◎
	○	◎

* This is to be used as a guide only. Please note that the effects vary depending on the operating conditions.



For the static neutralization of films

- Prevents the adhesion of dust
- Prevents winding failure due to wrinkles, etc.

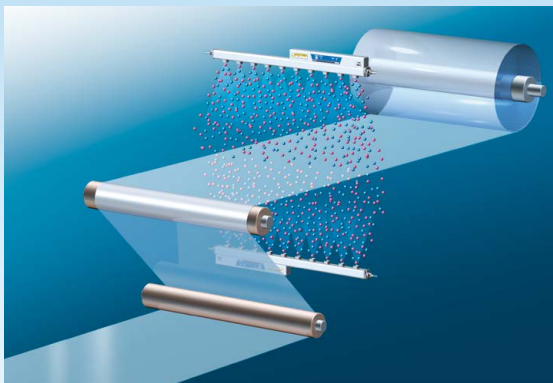

For the static neutralization of film-molded goods

- Prevents goods from adhering to the conveyer
- Prevents the dispersion of finished goods

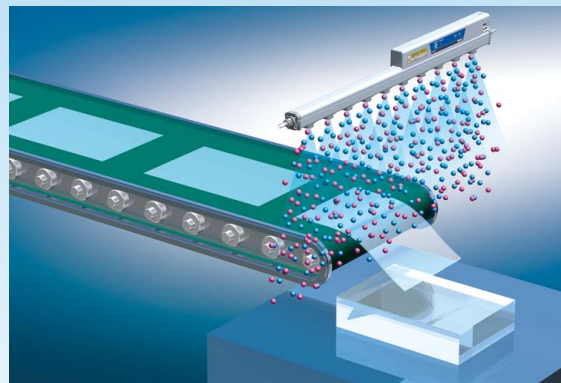

For the static neutralization during wafer transfer

- Prevents breakage due to discharge between wafers and hands

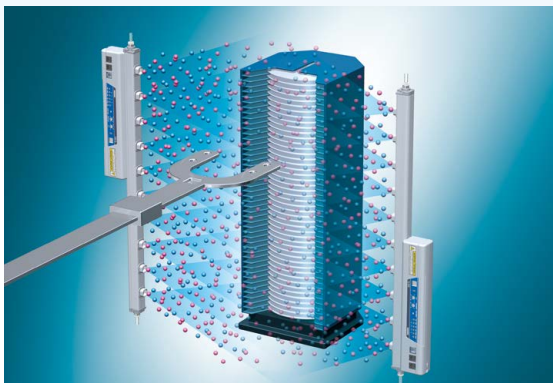

For the static neutralization of packing films

- Prevents the filled substances from adhering to packing films
- Reduces packing mistakes

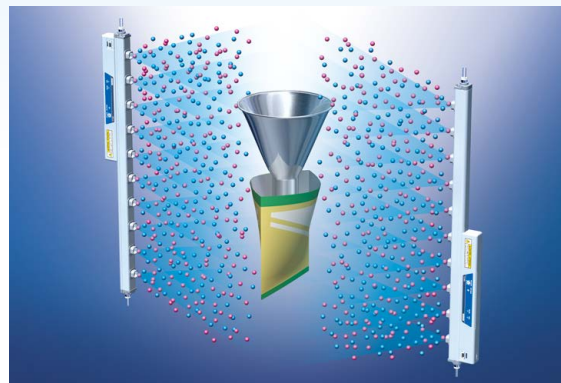

For the static neutralization of lenses

- Removes dust from lenses
- Prevents the adhesion of dust



For the static neutralization of parts feeders

- Prevents the clogging of parts feeders

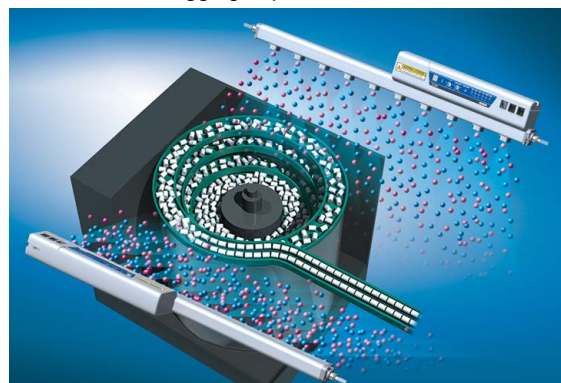

For the static neutralization of resin frames

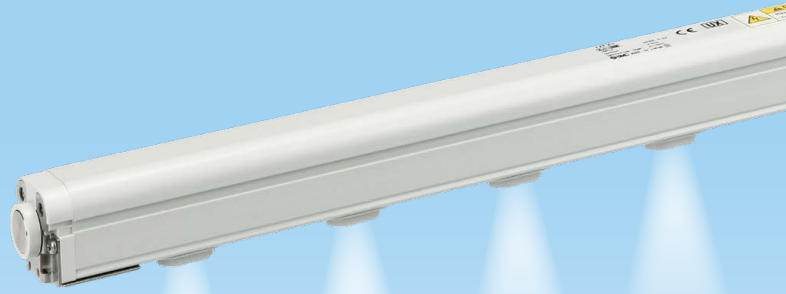
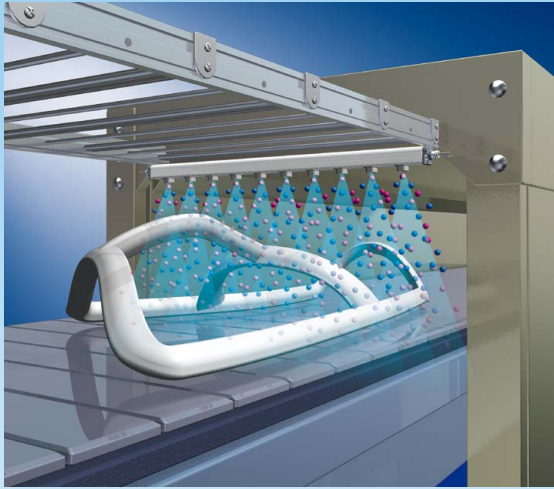

For the static neutralization of film-molded goods

- Prevents goods from adhering to the conveyer
- Prevents the dispersion of finished goods

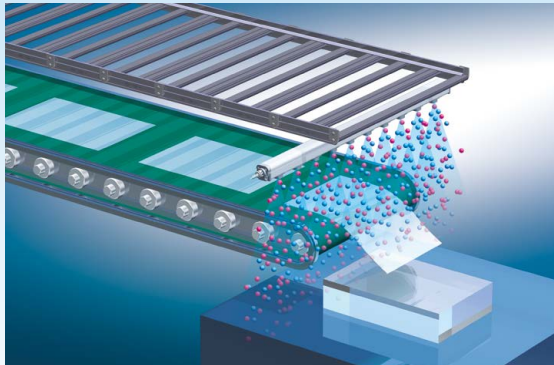

For the static neutralization of substrate cutting machines

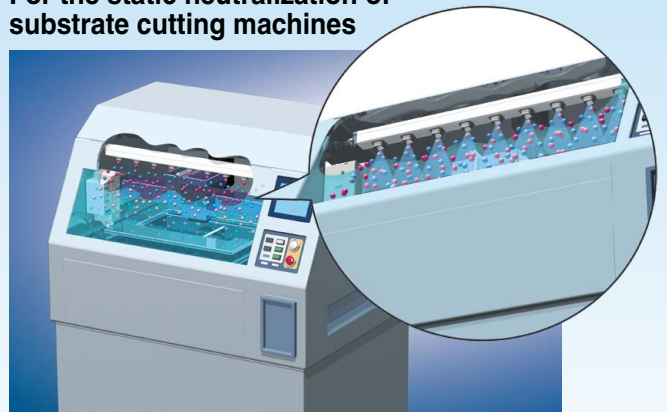

For the static neutralization of packing films

- Prevents the filled substances from adhering to packing films
- Reduces packing mistakes

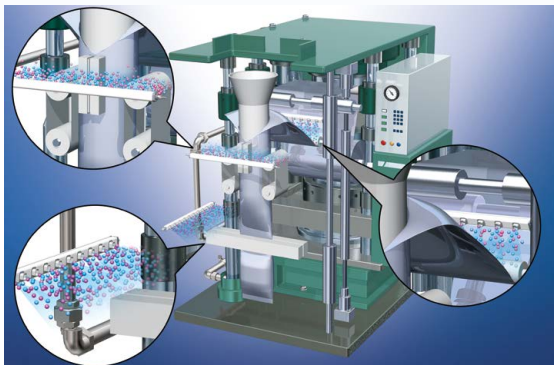

For the static neutralization during wafer transfer

- Prevents breakage due to discharge between wafers and hands

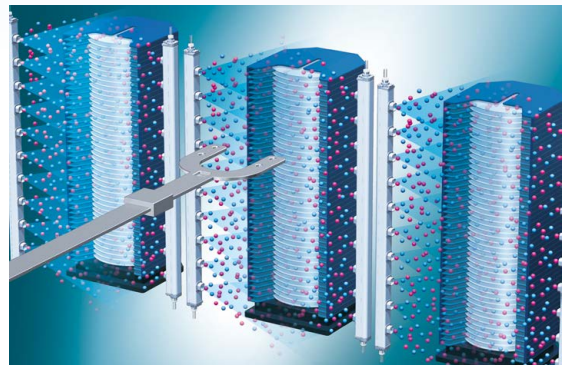

For the static neutralization of glass substrates

- Prevents the breakage of glass substrates by the static electricity generated when the substrate is lifted from the surface plate

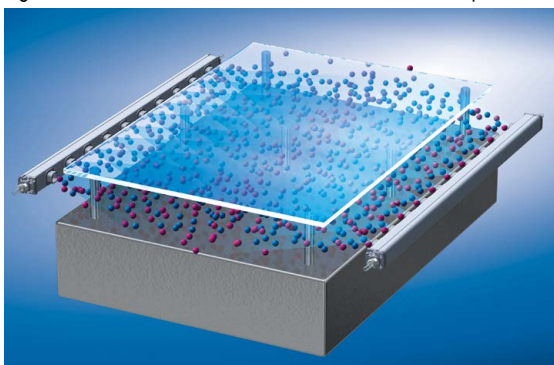

For the static neutralization of lenses

- Removes dust from lenses
- Prevents the adhesion of dust

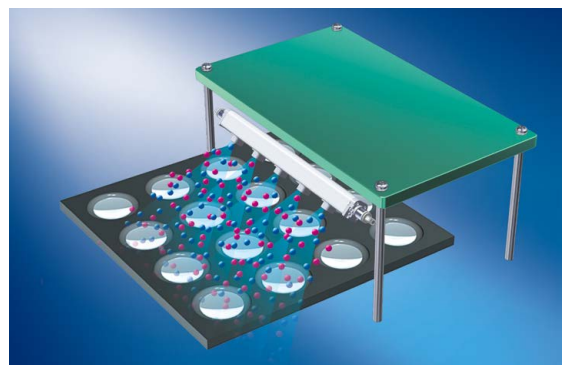

For the static neutralization of caps

- Removes dust from caps and prevents the adhesion of dust

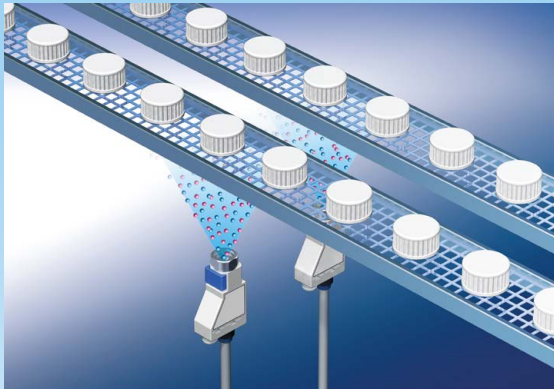

For the static neutralization of films

- Prevents the adhesion of dust
- Prevents winding failure due to wrinkles, etc.

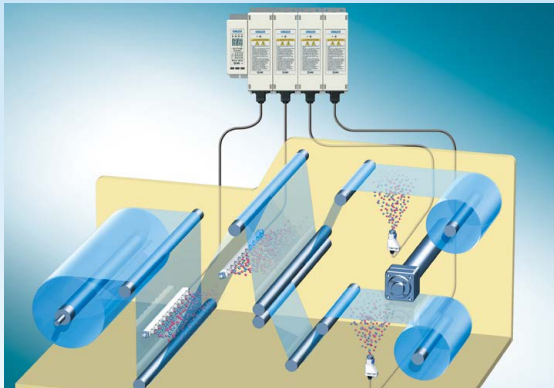

For the spot type static neutralization

- Prevents the electrostatic breakdown of electric parts
- Prevents detachment failure

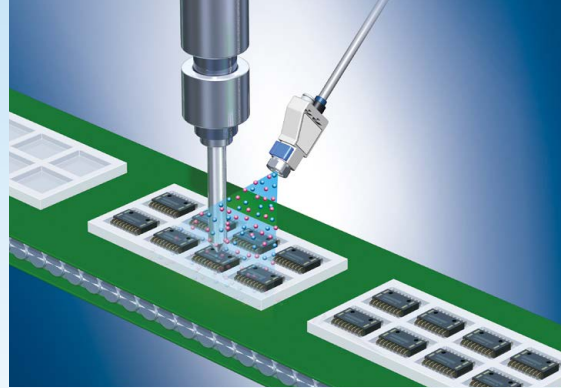

For the static neutralization of parts feeders

- Prevents the clogging of parts feeders

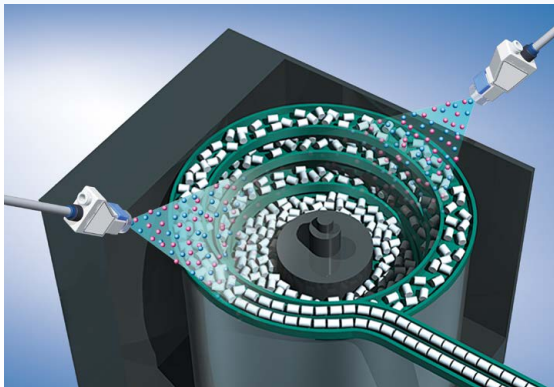

For the static neutralization of electric substrates

- Prevents the electrostatic breakdown of electric parts

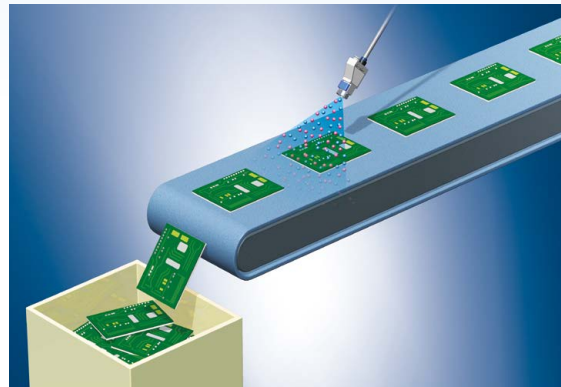

For the removal of dust when detaching from film

- Removes dust generated by static electricity when detaching from film

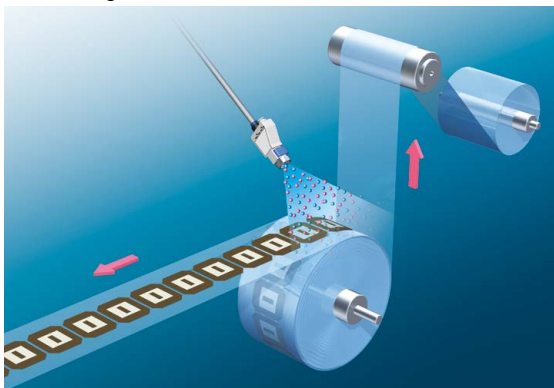

For the prevention of punching press sticking

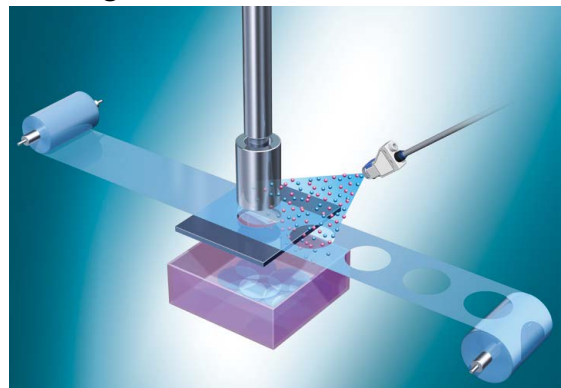



For the dust removal and static neutralization by air blow

- For plastic bottle static neutralization and particle elimination

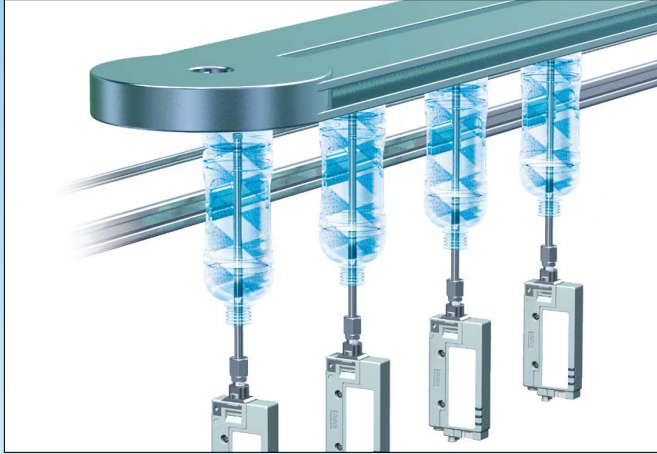

For the spot type static neutralization

- Prevents the electrostatic breakdown of electric parts
- Prevents detachment failure

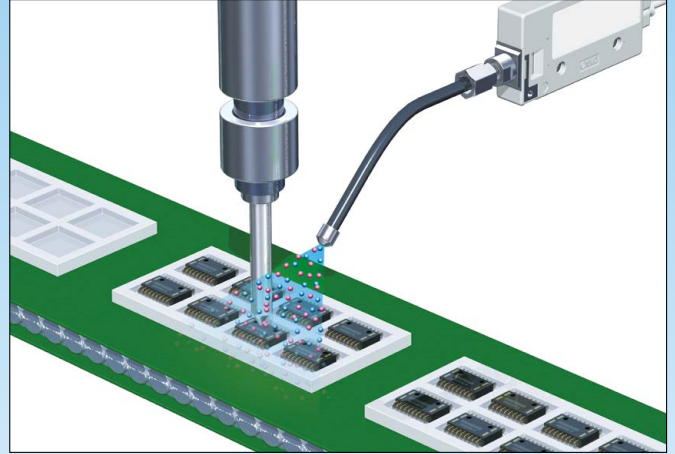

For the static neutralization of electric substrates

- Prevents the electrostatic breakdown of electric parts

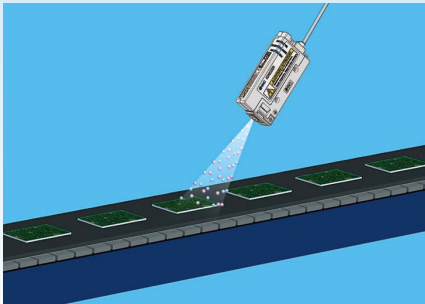

For the static neutralization of lenses

- Removes dust from lenses
- Prevents the adhesion of dust

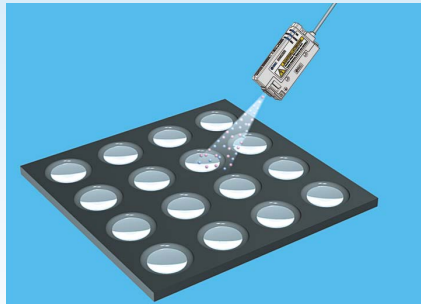

For the static neutralization of packing films

- Prevents the generation of static electricity when opening bags
- Prevents clinging due to static electricity on the inside of candy bags

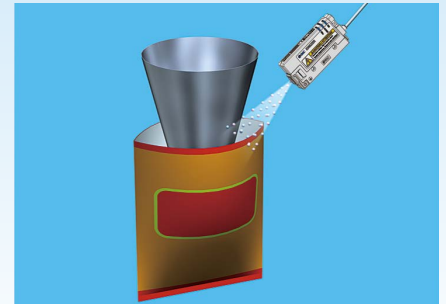

For the static neutralization of molded goods

- Prevents problems with the separation of molded plastic goods

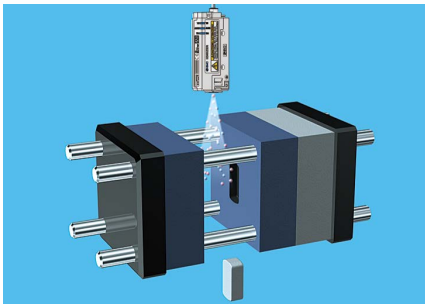

For the static neutralization of plastic cups

- Removes dust clinging to the inside of cups



For the static neutralization of parts feeders

- Prevents the clogging of parts feeders

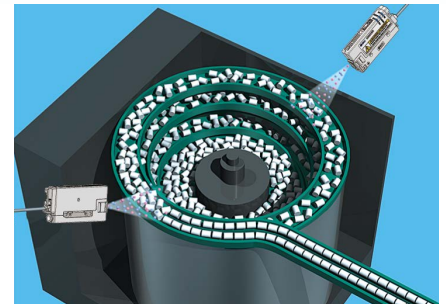

Static neutralization in narrow spaces is possible.

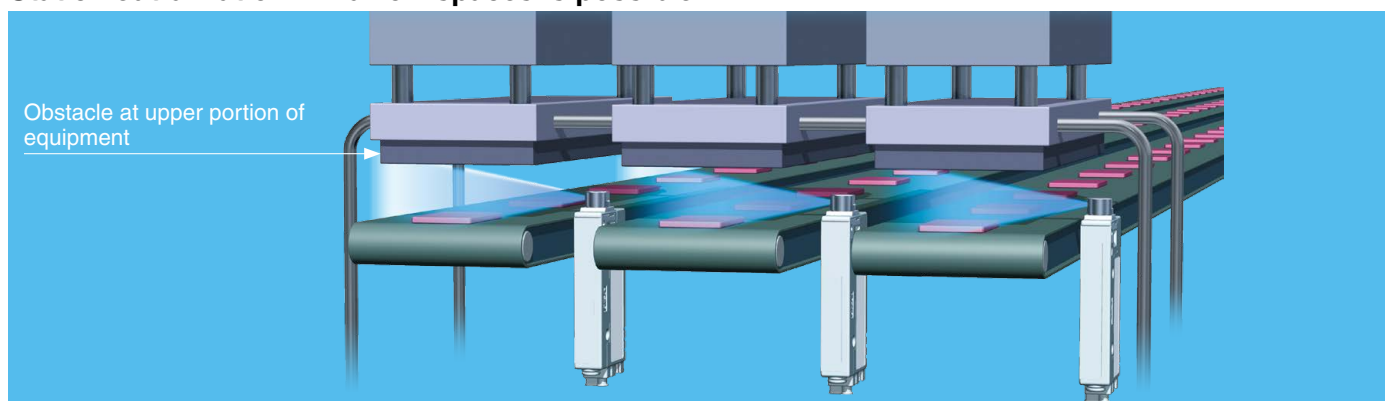



For the static neutralization of conveyors

- Static neutralization in a narrow space

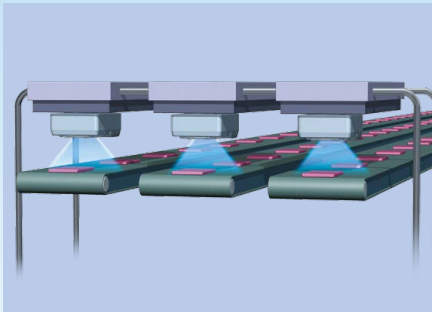

For the static neutralization of PET bottles

- Trip-resistance during conveying
- Prevents adhesion of dust

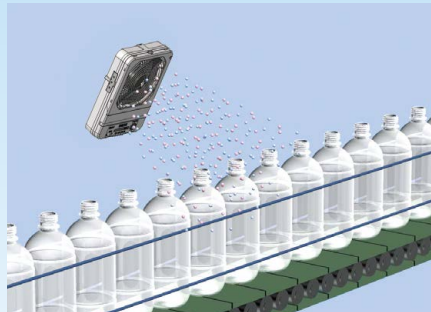

For the static neutralization of films

- Prevents winding failure
- Prevents adhesion of dust

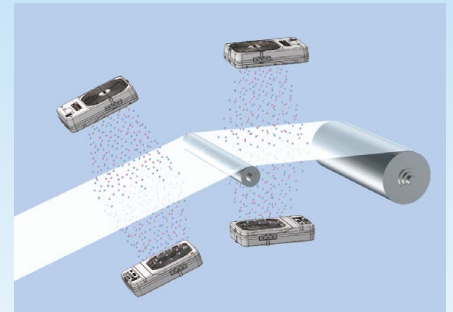

For the static neutralization of molded goods

- Improves detachability of molded goods from a die

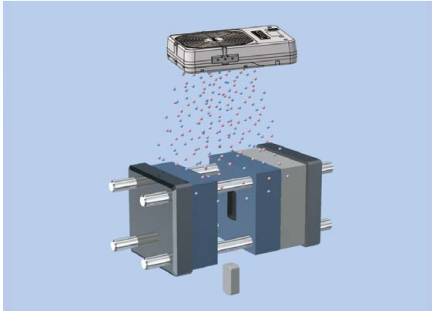

For the static neutralization of film-molded goods

- Sticking and scattering prevention on a conveyor

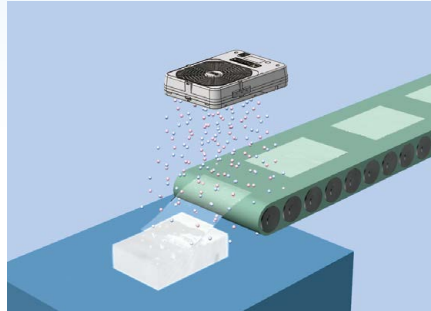

For the static neutralization of packaging materials made from polystyrene foam

- Darkening due to dust adhesion prevented

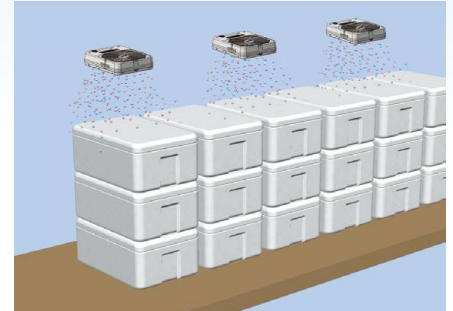

For the static neutralization of packing films

- Prevents the filled substance from adhering to the packing film and reduces packing mistakes

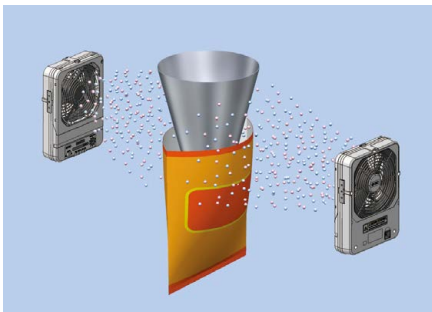

For the static neutralization of parts feeders

- Prevents the clogging of parts feeders

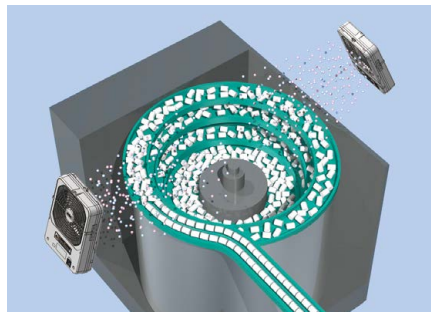

For the static neutralization of electric substrates

- Prevents failures due to ESD and adhesion of dust

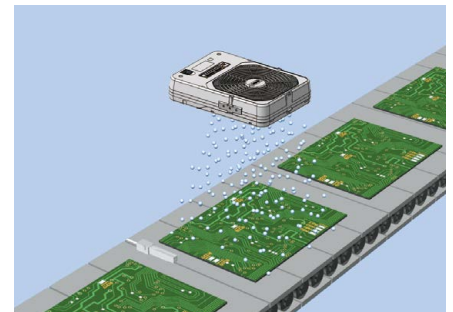

Application Examples

Ionizer Gun (Handheld Type) IZG10 Series



For the static neutralization and dust removal of resin parts

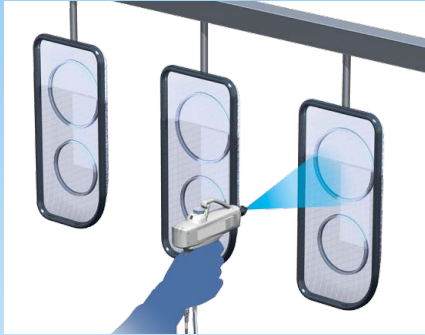

For the static neutralization and dust removal of resin parts



For the dust removal of resin products

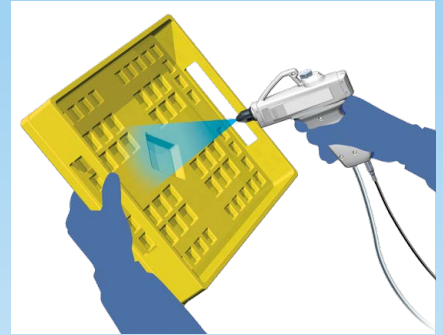

For the static neutralization and dust removal of electric substrates

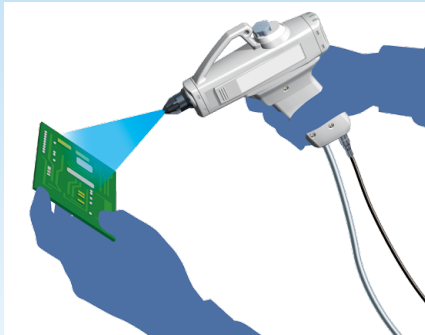

For the static neutralization and dust removal of resin parts with the ionizer suspended from above



For the dust removal when detaching from film

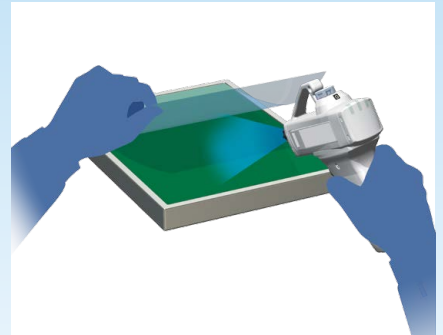

Application Examples

Desktop Duster Box ZVB Series

Supports workpieces of various sizes



Electronic components

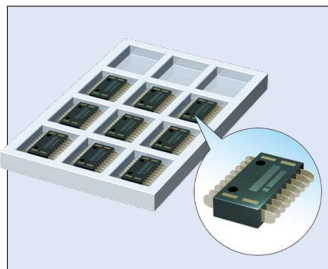

Lens

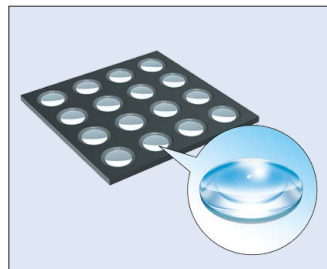

Lamp cover

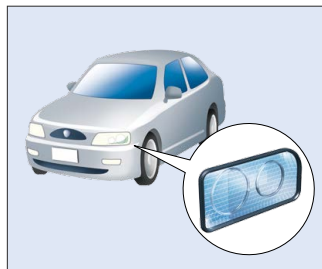

Cosmetic case



Parts for home appliances



Smartphone

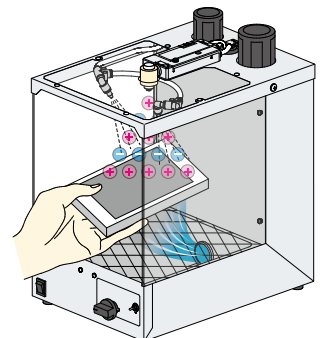

Peripheral Equipment

SMC can provide all the equipment required to supply air to the ionizer.

Consider the equipment below to provide opportunities to decrease maintenance and preventing damage.

Recommended pneumatic circuit diagram

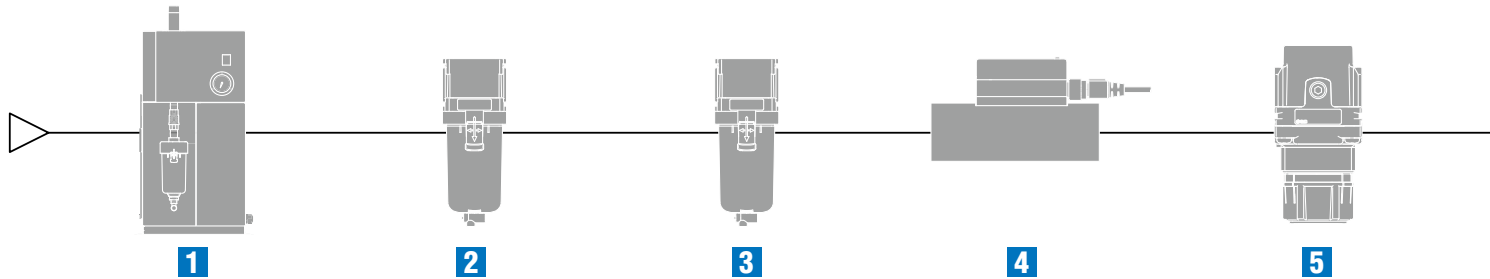

1 Air Dryer

Removes moisture in the compressed air

IDF Series



Catalog



2 Air Filter/Line Filter

Eliminates solid foreign matter such as powder particles in the compressed air

AF Series



Catalog



AFF Series



Catalog



3 Mist Separator

Eliminates oil mist which is difficult to eliminate with an air filter

AFM Series



Catalog



AM Series



Catalog



4 3-Color Display Digital Flow Switch

Flow range: Max. 12000 L/min
Flow ratio: 100:1

PF3A7□H Series



Catalog



5 Regulator

Reduces air consumption by setting to an appropriate pressure

AR Series



Catalog



2-Color Display Digital Flow Switch*1

Flow range: Max. 2000 L/min
Flow ratio: 100:1

PFMB Series



Catalog



*1 Check individual catalogs and install appropriate air preparation equipment.

Caution

Install an air dryer, air filter, line filter, and/or mist separator to obtain clean compressed air (A compressed air quality of Class 2.6.3 or higher according to ISO 8573-1:2010 is recommended for operation.).



6

6 Clean Air Filter*1

For use in clean rooms
Built-in hollow fiber element, Nominal filtration rating: 0.01 μm
Hollow fiber elements with over 99.99% filtering efficiency prevent workpiece contamination.

Catalog



SFD Series



* Please contact SMC for clean room compatible ionizers.

Clean Air Module*1

Modularized digital flow switch, regulator, ON/OFF valve, restrictor, and filter

Catalog



LLB Series

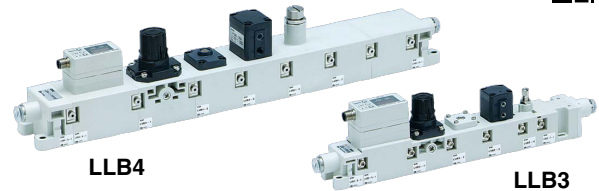

* Please contact SMC for clean room compatible ionizers.

*1 Check individual catalogs and install appropriate air preparation equipment.

Related Products

Polyurethane Coil Tubing

Flexible
Max. operating pressure: 0.8 MPa (at 20°C)
For moving applications
* Colors other than black are available as made-to-order specifications.

Catalog



TCU Series

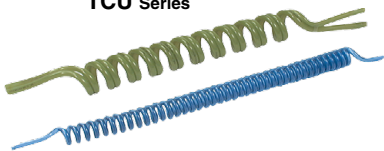

S Couplers

One-touch fitting type standardized (KK)
Uses ultra high-impact PBT resin (KKH)

Catalog



KK Series

KKH Series



Finger Valve

The valve direction clearly indicates whether the valve is open or closed.
Small knob operating force (0.04 to 0.14 N·m)

Catalog



VHK-A Series

