

Electric Vacuum Gripper for Collaborative Robots

A vacuum gripper that doesn't require an air source

Unitization of the peripheral devices required for adsorption Operation is possible by simply connecting 1 electrical cable

Built in

Vacuum pump

Atmospheric release valve

Pressure monitor

Lightweight: 556 g

A wide variety of cup variations are available to support a wide range of workpiece shapes.

Can be used with the collaborative robots of 4 companies

· UNIVERSAL ROBOTS

New OMRON/TECHMAN ROBOT

New FANUC CORPORATION

New YASKAWA Electric Corporation



Energy-saving operation possible via automatic/manual modes

Current consumption Max. 64% reduction

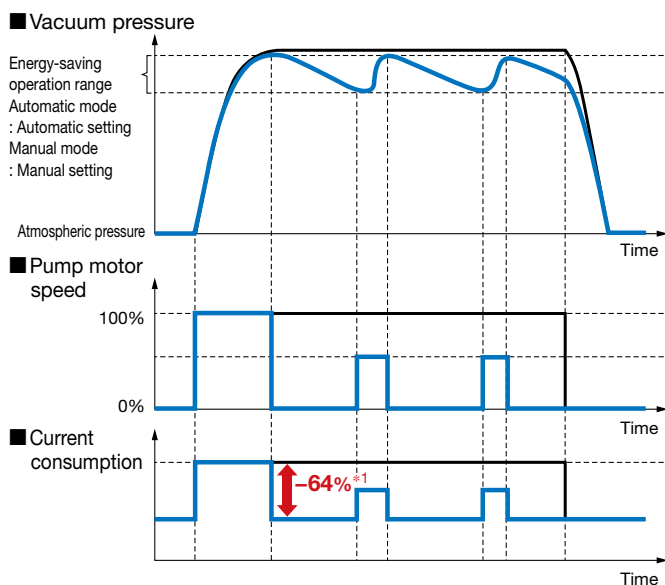

* The vacuum pressure waveform is only for reference. The actual operation may vary depending on the conditions such as the workpiece, pad, temperature, etc. Be sure to perform verification sufficiently prior to use.

*1 64% reduction in current consumption during pump stop and pump operation when using energy-saving operation. (Based on SMC's measurement conditions) This excludes sudden currents.

Easy tool changing (Manual changer)

- Tools can be secured by simply tightening the 2 clamber bolts.
- Reduces work-hours



ZXPE5 Series

SMC

CAT.ES160-9A A



- Operation possible by simply connecting an electrical cable connector**
Can be used without an air source due to the built-in vacuum pump
- Unitization of the peripheral devices required for adsorption**
The vacuum pump, atmospheric release valve, pressure monitor, and cups have been integrated.
- 3 operation modes**
Automatic mode, Manual mode, and Continuous mode
- Equipped with a diagnosis function that allows you to check the state of the product**
Compares the initial state and current state of vacuum pressure when not adsorbing a workpiece
Compares the factory default settings and current settings of the max. vacuum pressure
- A wide variety of cup variations are available to support a wide range of workpiece shapes.**
- 360° LED display of status**

Specifications

Body specifications	Standards		Conforming to ISO9409-1-50-4-M6
	Operating temperature range [°C]		5 to 40
	Connector type		M8 8-pin (Plug)
	Weight [g]	Body*1	722 (556)
		Connector cable	Refer to the "Robot Compatible Connector Cable" on page 6.
		Cup with adapter	Refer to "Cup Part Numbers" on page 4.
	Max. work load [kg]*2		5
	Max. vacuum pressure [kPa]*3		-74
	Max. suction flow rate [L/min(ANR)]*3		4.5
Noise level [dB(A)]*4		60	
Power specifications	Power supply voltage [V]		24 VDC ±10%
	Current consumption [mA]*5	Max. current*6	1400
		Standby current*7	60
IO communication input specifications	Input type		PNP/NPN
	Input ON voltage		15 V or more
	Input ON current		3 mA or more
	Input OFF voltage		5 V or less
	Input OFF current		0.5 mA or less
IO communication output specifications	Output type		PNP/NPN
	Max. load current [mA]		200
	Protection		Short-circuit protection

*1 The weight of the main plate assembly is included. However, that of the connector cable and cup with adapter is not included.

The weight in parentheses refers to the weight of the product without a cup mounting flange assembly.

*2 May be restricted depending on the cup diameter, mounting orientation, or workpiece. Please use within the max. work load. Suction and transfer exceeding the max. work load may result in product failure and the dropping of workpieces.

*3 These are the values under SMC measurement conditions when the gripper is in continuous mode (the vacuum pump working continuously) and may vary depending on the atmospheric pressure (weather, altitude, etc.) and the measurement method.

*4 Actual values under SMC's measurement conditions (Not guaranteed values)

*5 This represents the value when supply voltage of 24 VDC is applied.

*6 Includes sudden currents

*7 The standby current represents an average current when the electric vacuum gripper is on standby.

Cup Variations

The number of cups can be changed.

(Refer to the operation manual for details on changing the quantity.)



1 cup

2 cups

4 cups

The cup type can be changed.

(For details on selectable cups, refer to "How to Order.")



Flat (ø8), Silicone rubber*2, *3

Bellows (ø20), NBR

Flat (ø32), Urethane rubber



ø32, 2.5-stage, Silicone rubber*2, *3

ø25, 5.5-stage, Silicone rubber*2, *3

*2 Uses a material compliant with a dissolution test of the FDA (USA Food and Drug Administration) regulation 21CFR§177.2600 for "Rubber articles intended for repeated use."

*3 Uses a material compliant with the standards for "Rubber apparatus (excluding baby drinking apparatus) and containers/packaging" (D3) (Partial revision: Japanese Ministry of Health, Labour, and Welfare Notification No. 595, 2012) in Section 3 "Apparatus and Containers/Packaging" of the Japan Food Sanitation Act, Article 18 "Specifications and Standards for Food and Food Additives, etc." (Japanese Ministry of Health and Welfare Notification No. 370, 1959)

The cup pitch can be changed.

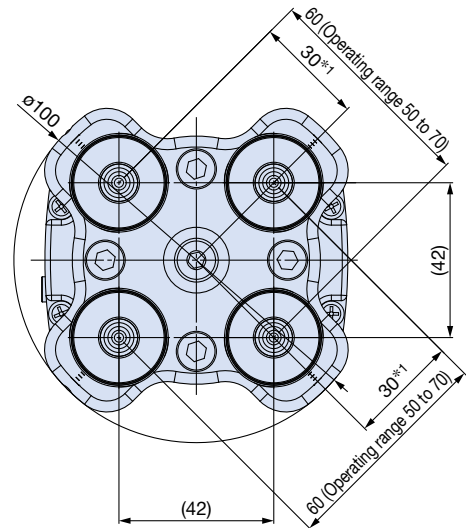

*1 Operating range: 25 to 35 (When a cup is mounted in the center)

As interference between cups may occur depending on the cup diameter, select the cup diameter according to the pitch to be used.

Component Parts

Main plate assembly

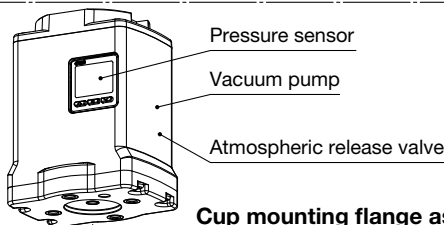
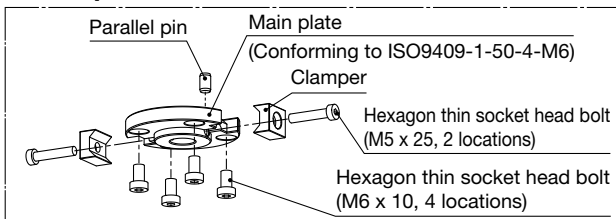

Cup mounting flange assembly

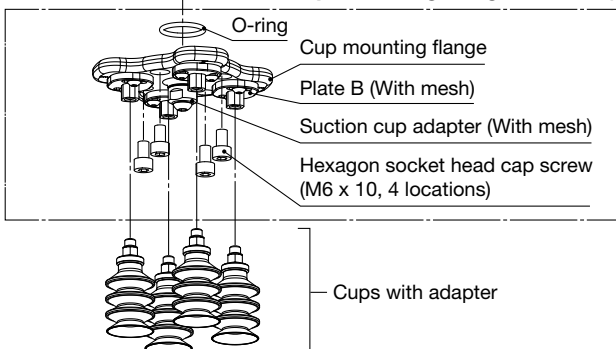

Accessories

Description	Quantities	Note
Main plate assembly	(1)	
Connector cable	(1)	Refer to "Robot Compatible Connector Cable" on page 6.
Cup with adapter	(4)	
Plug*1	(4)	

Varies depending on the product part number

*1 For use when changing the number of suction cups (Refer to the Operation Manual)

Replacement Parts

Description	Part number	Quantities	Included parts
Cup mounting flange assembly	ZXPE5-PFL1-A	1	Cup mounting flange, Plate B, Suction cup adapter, Mounting bolt, Plug, O-ring
Plate B	ZXPE5-APL6-A	1	Plate B, Mounting bolt, O-ring
Suction cup adapter	ZXPE5-EXP6	1	Extension adapter, Plug, O-ring
Main plate assembly	RMTM2-4M1	1	Main plate, Mounting bolt, Clamper, Parallel pin
Connector cable	Refer to "Robot Compatible Connector Cable" on page 6.	1	
Cup with adapter	Refer to "Cup Part Numbers" on page 4.	1	
Plug*2	M-3P	1	

*2 For use when changing the number of suction cups (Refer to the Operation Manual)

Plug-in Software

Compatible with robots from UNIVERSAL ROBOTS, OMRON Corporation/TECHMAN ROBOT, FANUC CORPORATION, and YASKAWA Electric Corporation

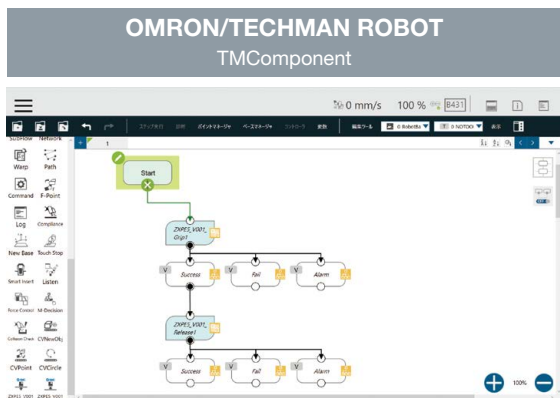
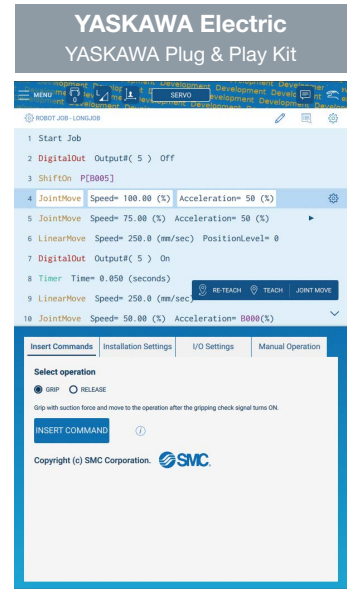
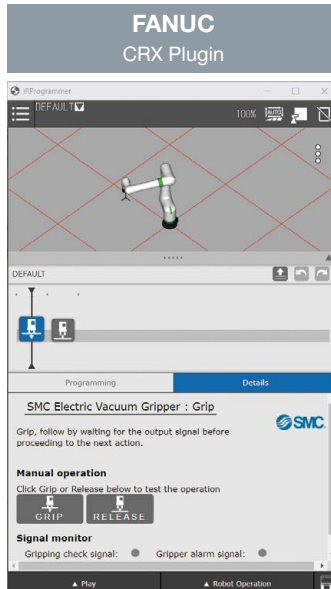
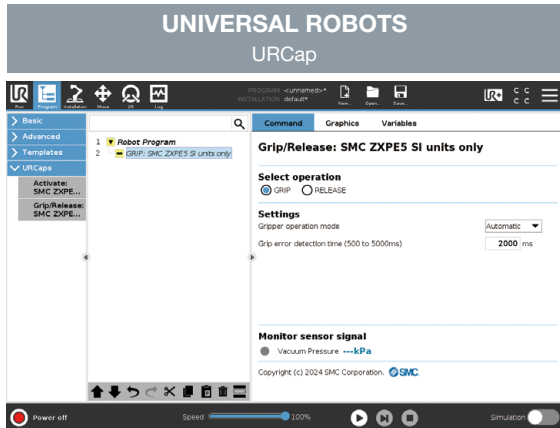

CONTENTS

For Adsorption Electric Vacuum Gripper ZXPE5 Series	
Features	p. 1
Specifications	p. 1
Cup Variations	p. 2
Component Parts	p. 2
Accessories	p. 2
Replacement Parts	p. 2
Plug-in Software	p. 2-1
How to Order	p. 3
Cup Part Numbers	p. 4
Dimensions	p. 5
Options	p. 6
Specific Product Precautions	p. 6-1

Electric Vacuum Gripper for Collaborative Robots

ZXPE5 Series



How to Order

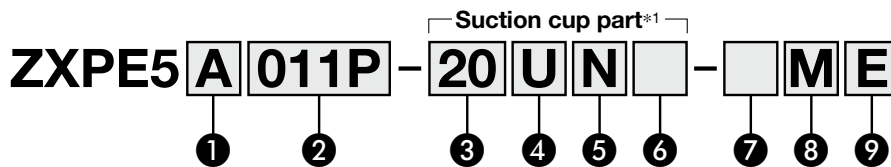

*1 Refer to page 4 for the applicable cups. For models with cups, 4 cups with adapters are included in the package.

① Cup mounting flange assembly

A	With flange assembly (42 mm x 42 mm)
N	Without flange assembly

② Compatible robot

Refer to the "Table 1 Compatible Robot List."

③ Cup diameter

Nil	Without cup	20	ø20
08	ø8	25	ø25
10	ø10	30	ø30
13	ø13	32	ø32
16	ø16		

④ Cup form

Nil	Without cup
U	Flat
C	Flat with rib
B	Bellows
UT	Thin flat
J	Multistage bellows
JT2	2.5-stage bellows
JT5	5.5-stage bellows
PT	Flat type for film packaging workpieces

⑤ Cup material

Nil	Without cup
N	NBR
S	Silicone rubber (White)*2, *3
U	Urethane rubber
F	FKM
SF	Silicone rubber (Blue)*2, *3

*2 Uses a material compliant with a dissolution test of the FDA (USA Food and Drug Administration) regulation 21CFR§177.2600 for "Rubber articles intended for repeated use."

*3 Uses a material compliant with the standards for "Rubber apparatus (excluding baby drinking apparatus) and containers/packaging" (D3) (Partial revision: Japanese Ministry of Health, Labour, and Welfare Notification No. 595, 2012) in Section 3 "Apparatus and Containers/Packaging" of the Japan Food Sanitation Act, Article 18 "Specifications and Standards for Food and Food Additives, etc." (Japanese Ministry of Health and Welfare Notification No. 370, 1959)

⑥ Cup attachment*4

Nil	With (guide) attachment
M	With mesh attachment
F	With flat attachment

*4 Only applicable to cup form "JT□"
Note that "M" and "F" apply only to cup form: JT2.

⑦ Robot connection cable

Nil	With connector cable
N	Without connection cable

⑧ Pressure monitor unit specifications

C	With unit switching function*5
M	SI unit only*6

*5 Under the New Measurement Act, switches with the unit switching function are not permitted for use in Japan.

*6 Fixed unit: kPa, MPa

⑨ Manual changer

E	With main plate assembly
F	Without main plate assembly

The main plate assembly is required to mount the gripper to the robot. In addition, when the main plate assembly is mounted to the robot, several different tool models can be used with the robot. Customers who already have a main plate assembly can select option "F" (Without main plate assembly).

Table 1 Compatible Robot List

Identification symbol	Robot manufacturer	Supported model	Input/Output type
011P	UNIVERSAL ROBOTS	UR3(e)*7	PNP
		UR5(e)*7	
		UR10(e)*7	
		UR16e	
021N	OMRON/TECHMAN ROBOT	TM5(S)	NPN
		TM7S	
		TM12(S)	
		TM14(S)	
043N	YASKAWA Electric	MOTOMAN-HC10(S)DTP	NPN
MOTOMAN-HC20(S)DTP		PNP	
MOTOMAN-HC10(S)DTP			
MOTOMAN-HC20(S)DTP			
051P	FANUC	CRX-5iA	PNP
		CRX-10iA(L)	
		CRX-20iA	
		CRX-25iA	

*7 URCap can only be used with the e-Series.

Cup Part Numbers

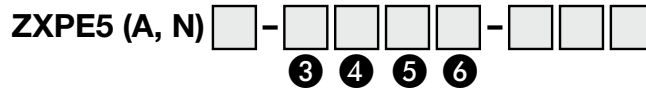

* Refer to the **Web Catalog** for details on suction cups.

Cup part numbers

③ Cup diameter	④ Cup form	⑤ Cup material	⑥ Cup attachment	Cup with adapter				Adapter unit (Vacuum inlet: Male thread M6 x 1)	Cup unit	
				Part no.	Weight by cup material (g/cup)					
					N (NBR)	S/SF (Silicone)	U (Urethane)			F (FKM)
08	U	<input type="checkbox"/>		ZPT08U□-A6	4	4	4	4	ZPT1-A6	ZP08U□
08	B	<input type="checkbox"/>		ZPT08B□-A6	4	4	4	4		ZP08B□
10	UT	<input type="checkbox"/>		ZPT10UT□-A6	4	4	4	4		ZP10UT□
13	UT	<input type="checkbox"/>		ZPT13UT□-A6	4	4	4	4		ZP13UT□
16	UT	<input type="checkbox"/>		ZPT16UT□-A6	4	4	4	4		ZP16UT□
10	U	<input type="checkbox"/>		ZPT10U□-AS6	7	7	7	7		ZPT2-AS6
13	U	<input type="checkbox"/>		ZPT13U□-AS6	7	7	7	8	ZP13U□	
16	U	<input type="checkbox"/>		ZPT16U□-AS6	7	7	7	8	ZP16U□	
20	U	<input type="checkbox"/>		ZPT20U□-AS6	9	10	10	10	ZPT3-AS6	ZP20U□
25	U	<input type="checkbox"/>		ZPT25U□-AS6	10	10	10	11		ZP25U□
32	U	<input type="checkbox"/>		ZPT32U□-AS6	10	11	11	12		ZP32U□
10	C	<input type="checkbox"/>		ZPT10C□-AS6	7	7	7	7	ZPT2-AS6	ZP10C□
13	C	<input type="checkbox"/>		ZPT13C□-AS6	7	7	7	7		ZP13C□
16	C	<input type="checkbox"/>		ZPT16C□-AS6	7	7	7	8		ZP16C□
20	C	<input type="checkbox"/>		ZPT20C□-AS6	9	10	10	11	ZPT3-AS6	ZP20C□
25	C	<input type="checkbox"/>		ZPT25C□-AS6	10	10	10	11		ZP25C□
32	C	<input type="checkbox"/>		ZPT32C□-AS6	10	11	11	12		ZP32C□
10	B	<input type="checkbox"/>		ZPT10B□-AS6	7	7	7	8	ZPT2-AS6	ZP10B□
13	B	<input type="checkbox"/>		ZPT13B□-AS6	7	8	8	8		ZP13B□
16	B	<input type="checkbox"/>		ZPT16B□-AS6	8	8	8	9		ZP16B□
20	B	<input type="checkbox"/>		ZPT20B□-AS6	11	11	11	13	ZPT3-AS6	ZP20B□
25	B	<input type="checkbox"/>		ZPT25B□-AS6	11	12	12	14		ZP25B□
32	B	<input type="checkbox"/>		ZPT32B□-AS6	14	15	15	18		ZP32B□
20	UT	<input type="checkbox"/>		ZPT20UT□-AS6	4	4	4	4	ZPT1-A6	ZP2-20UT□
16	J	<input type="checkbox"/>		ZP2-T16J□-AS6	8	8	8	9	ZPT2-AS6	ZP2-16J□
25	J	<input type="checkbox"/>		ZP2-TB25J□-AS6	14	15	15	18	ZPT3-AS6	ZP2-B25J□
30	J	<input type="checkbox"/>		ZP2-TB30J□-AS6	18	19	19	25		ZP2-B30J□
20	JT2	SF		ZP3P-T20JT2SF-W-AS6	—	21	—	—	ZP3PA-T1JT-AS6	ZP3P-20JT2SF-W
20	JT2	SF	M	ZP3P-T20JT2SF-WM-AS6	—	21	—	—		ZP3P-20JT2SF-WM
20	JT2	SF	F	ZP3P-T20JT2SF-WF-AS6	—	21	—	—		ZP3P-20JT2SF-WF
25	JT2	SF		ZP3P-T25JT2SF-W-AS6	—	21	—	—		ZP3P-25JT2SF-W
25	JT2	SF	M	ZP3P-T25JT2SF-WM-AS6	—	21	—	—		ZP3P-25JT2SF-WM
25	JT2	SF	F	ZP3P-T25JT2SF-WF-AS6	—	21	—	—		ZP3P-25JT2SF-WF
32	JT2	SF		ZP3P-T32JT2SF-W-AS6	—	37	—	—	ZP3PA-T2JT-AS6	ZP3P-32JT2SF-W
32	JT2	SF	M	ZP3P-T32JT2SF-WM-AS6	—	37	—	—		ZP3P-32JT2SF-WM
32	JT2	SF	F	ZP3P-T32JT2SF-WF-AS6	—	37	—	—		ZP3P-32JT2SF-WF
20	JT5	SF		ZP3P-T20JT5SF-AS6	—	23	—	—	ZP3PA-T1JT-AS6	ZP3P-20JT5SF-WG
25	JT5	SF		ZP3P-T25JT5SF-AS6	—	25	—	—		ZP3P-25JT5SF-WG
32	JT5	SF		ZP3P-T32JT5SF-AS6	—	43	—	—	ZP3PA-T2JT-AS6	ZP3P-32JT5SF-WG
20	PT	SF		ZP3P-T20PTSF-AS6	—	20	—	—	ZP3PA-T1-AS6	ZP3P-20PTSF
25	PT	SF		ZP3P-T25PTSF-AS6	—	20	—	—		ZP3P-25PTSF

Input the material symbol ("N," "S," "U," or "F") into the □ in the part number.

ZXPE5 Series Options

Robot Compatible Connector Cable

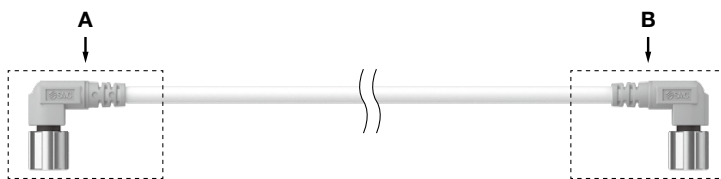

Identification symbol	Robot manufacturer	A Vacuum gripper side	B Robot side	Part no.	Weight [g]
011P	UNIVERSAL ROBOTS	M8 8-pin connector (Socket)	M8 8-pin connector (Socket)	RMH-A00-11-A	16
021N	OMRON/TECHMAN ROBOT		M8 8-pin connector (Plug)	RMH-A00-11-B	14
043N, 043P	YASKAWA Electric		M8 8-pin connector (Socket)	RMH-A00-11-A	16
051P	FANUC		M8 8-pin connector (Socket)	RMH-A00-11-A	16

Suction Cup

For suction cup part numbers, refer to “Cup Part Numbers” on page 4.

⚠ Specific Product Precautions

Be sure to read this before handling the products. Refer to the back cover for safety instructions. For vacuum equipment precautions, refer to the “Handling Precautions for SMC Products” and the “Operation Manual” on the SMC website: <https://www.smcworld.com>

Handling

⚠ Caution

1. Strictly observe the precautions on vacuum equipment and safety when using the product. Additionally, select a cup size and material suitable to both the workpiece to be adsorbed and the atmosphere.
Take safety measures so that any accident, such as the dropping of a workpiece, does not occur during adsorption transfer. For details, refer to the **Web Catalog**.
2. Use the product within the specification range. Use exceeding the voltage may result in serious damage due to reduced product performance.
3. Exhaust air is released from the opening in the product. Therefore, do not restrict the exhaust air by blocking the opening.

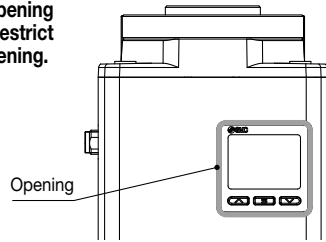

4. The electric vacuum gripper monitors the pressure and controls the operation for grip and release movements. The integrity of the system should be determined after thorough verification on the actual machine.

Mounting

⚠ Caution

1. For details on the mounting method, refer to the **Operation Manual**.
2. Tighten to the specified tightening torque. If the tightening torque is exceeded, the body and the mounting screws may break.
3. Do not drop, strike, or apply excessive impact to this product. Doing so may result in damage to the internal parts of the body, atmospheric release valve, pressure monitor, or vacuum pump. In some cases, this damage may result in a malfunction.
4. The bolts may loosen due to the operating conditions and environment. Be sure to conduct maintenance such as tightening the bolts periodically.

Wiring

⚠ Caution

1. Avoid repeatedly bending or stretching the connector cable as well as applying force to it.
2. Do not wire while energizing the product. Doing so may result in damage to the internal parts of the atmospheric release valve, pressure monitor, or vacuum pump. In some cases, this damage may result in a malfunction.
3. Do not disassemble the connector cable or make any modifications, including additional machining. Doing so may cause human injury and/or an accident.

Safety Instructions

These safety instructions are intended to prevent hazardous situations and/or equipment damage. These instructions indicate the level of potential hazard with the labels of “**Caution**,” “**Warning**” or “**Danger**.” They are all important notes for safety and must be followed in addition to International Standards (ISO/IEC)*1), and other safety regulations.

 **Danger :** **Danger** indicates a hazard with a high level of risk which, if not avoided, will result in death or serious injury.

 **Warning:** **Warning** indicates a hazard with a medium level of risk which, if not avoided, could result in death or serious injury.

 **Caution:** **Caution** indicates a hazard with a low level of risk which, if not avoided, could result in minor or moderate injury.

*1) ISO 4414: Pneumatic fluid power - General rules and safety requirements for systems and their components
ISO 4413: Hydraulic fluid power - General rules and safety requirements for systems and their components
IEC 60204-1: Safety of machinery - Electrical equipment of machines - Part 1: General requirements
ISO 10218-1: Robots and robotic devices - Safety requirements for industrial robots - Part 1: Robots etc.

Warning

1. The compatibility of the product is the responsibility of the person who designs the equipment or decides its specifications.

Since the product specified here is used under various operating conditions, its compatibility with specific equipment must be decided by the person who designs the equipment or decides its specifications based on necessary analysis and test results. The expected performance and safety assurance of the equipment will be the responsibility of the person who has determined its compatibility with the product. This person should also continuously review all specifications of the product referring to its latest catalog information, with a view to giving due consideration to any possibility of equipment failure when configuring the equipment.

2. Only personnel with appropriate training should operate machinery and equipment.

The product specified here may become unsafe if handled incorrectly. The assembly, operation and maintenance of machines or equipment including our products must be performed by an operator who is appropriately trained and experienced.

3. Do not service or attempt to remove product and machinery/equipment until safety is confirmed.

1. The inspection and maintenance of machinery/equipment should only be performed after measures to prevent falling or runaway of the driven objects have been confirmed.
2. When the product is to be removed, confirm that the safety measures as mentioned above are implemented and the power from any appropriate source is cut, and read and understand the specific product precautions of all relevant products carefully.
3. Before machinery/equipment is restarted, take measures to prevent unexpected operation and malfunction.

4. Our products cannot be used beyond their specifications. Our products are not developed, designed, and manufactured to be used under the following conditions or environments. Use under such conditions or environments is not covered.

1. Conditions and environments outside of the given specifications, or use outdoors or in a place exposed to direct sunlight.
2. Use for nuclear power, railways, aviation, space equipment, ships, vehicles, military application, equipment affecting human life, body, and property, fuel equipment, entertainment equipment, emergency shut-off circuits, press clutches, brake circuits, safety equipment, etc., and use for applications that do not conform to standard specifications such as catalogs and operation manuals.
3. Use for interlock circuits, except for use with double interlock such as installing a mechanical protection function in case of failure. Please periodically inspect the product to confirm that the product is operating properly.

Caution

We develop, design, and manufacture our products to be used for automatic control equipment, and provide them for peaceful use in manufacturing industries.

Use in non-manufacturing industries is not covered.

Products we manufacture and sell cannot be used for the purpose of transactions or certification specified in the Measurement Act.

The new Measurement Act prohibits use of any unit other than SI units in Japan.

Limited warranty and Disclaimer/ Compliance Requirements

The product used is subject to the following “Limited warranty and Disclaimer” and “Compliance Requirements”.

Read and accept them before using the product.

Limited warranty and Disclaimer

1. The warranty period of the product is 1 year in service or 1.5 years after the product is delivered, whichever is first.*2)
Also, the product may have specified durability, running distance or replacement parts. Please consult your nearest sales branch.
2. For any failure or damage reported within the warranty period which is clearly our responsibility, a replacement product or necessary parts will be provided. This limited warranty applies only to our product independently, and not to any other damage incurred due to the failure of the product.
3. Prior to using SMC products, please read and understand the warranty terms and disclaimers noted in the specified catalog for the particular products.

*2) **Vacuum pads are excluded from this 1 year warranty.**

A vacuum pad is a consumable part, so it is warranted for a year after it is delivered.

Also, even within the warranty period, the wear of a product due to the use of the vacuum pad or failure due to the deterioration of rubber material are not covered by the limited warranty.

Compliance Requirements

1. The use of SMC products with production equipment for the manufacture of weapons of mass destruction (WMD) or any other weapon is strictly prohibited.
2. The exports of SMC products or technology from one country to another are governed by the relevant security laws and regulations of the countries involved in the transaction. Prior to the shipment of a SMC product to another country, assure that all local rules governing that export are known and followed.

Safety Instructions

Be sure to read the “Handling Precautions for SMC Products” (M-E03-3) and “Operation Manual” before use.

SMC Corporation

Akihabara UDX 15F,
4-14-1, Sotokanda, Chiyoda-ku, Tokyo 101-0021, JAPAN
Phone: 03-5207-8249 Fax: 03-5298-5362
<https://www.smcworld.com>
© 2024 SMC Corporation All Rights Reserved

Specifications are subject to change without prior notice and any obligation on the part of the manufacturer.

D-G