

Cylinder with Lock

CNG Series

ø20, ø25, ø32, ø40

A locking cylinder ideal for intermediate stops, emergency stops and drop prevention.

Simple construction

A force magnifying mechanism is employed based on the wedge effect of the taper ring and steel balls.

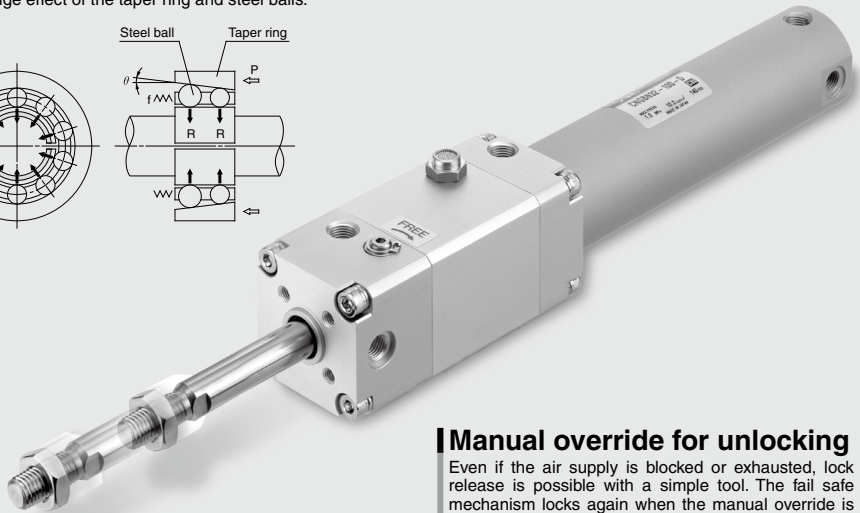
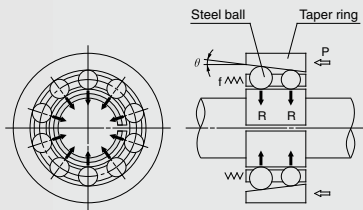

Manual override for unlocking

Even if the air supply is blocked or exhausted, lock release is possible with a simple tool. The fail safe mechanism locks again when the manual override is released.

High locking efficiency

Greater locking efficiency as well as stable locking and unlocking operation has been achieved by arranging a large number of steel ball bearings in circular rows. (Unlocking pressure of 0.25 MPa 0.05 MPa lower than current SMC products) In addition, both alignability and stable locking force with respect to piston rod eccentricity are obtained by allowing the taper ring to float.

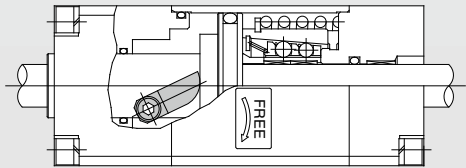

High reliability and stable holding force

Outstanding durability and stable holding force are maintained by the use of a brake shoe having superior wear resistance, which has also been substantially lengthened (double the current SMC product).

Design minimizes the influences of unlocking air quality

A construction which is strong against moisture and drainage in the compressed air has been realized by separating the locking mechanism and the unlocking chamber.

Series Variations

Series	Action	Cushion type		With rod boot	Bore size (mm)	Lock holding force (N)	Stroke (mm)
		Rubber bumper	Air cushion				
Cylinder with lock CNG series	Double acting, Single rod	●	●	●	20	215	Max. Up to 1500
		●	●	●	25	335	
		●	●	●	32	550	
		●	●	●	40	860	

Can be locked in both directions

Holding force is equal on either extend or retract.

CNG Series Model Selection

Precautions on Model Selection

⚠ Caution

- In order that the originally selected maximum speed is not exceeded, be certain to use a speed controller to adjust the total movement distance of the load so that movement takes place in no less than the applicable movement time.
The movement time is the time that is necessary for the load to travel the total movement distance from the start without any intermediate stops.
- In cases where the cylinder stroke and the movement distance of the load are different (double speed mechanism, etc.), use the movement distance of the load for selection purposes.

Example)

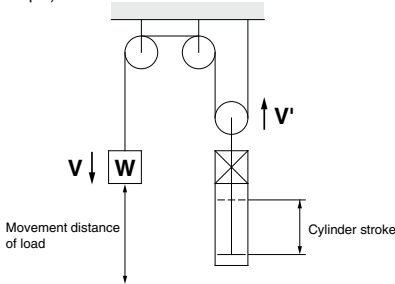

- The following selection example and procedures are based on use at the intermediate stop (including emergency stops during operation). However, when the cylinder is in a locked state, kinetic energy does not act upon it. Under these conditions, use the load mass at the maximum speed (V) of 100 mm/s shown in graphs (5) to (7) depending on the operating pressure and select models.

Selection Example

- Load mass: $m = 12 \text{ kg}$
- Movement distance: $st = 200 \text{ mm}$
- Movement time: $t = 0.8 \text{ s}$
- Load condition: Vertical downward = Load in direction of rod extension
- Operating pressure: $P = 0.4 \text{ MPa}$

Step (1): From graph (1) find the maximum movement speed of the load.

\therefore Maximum speed $V \approx 350 \text{ mm/s}$

Step (2): Select graph (6) based upon the load condition and operating pressure, and then from the intersection of the maximum speed $V = 350 \text{ mm/s}$ found in Step (1), and the load mass $m = 12 \text{ kg}$

$\therefore \phi 32 \rightarrow$ select a CNG32 or larger bore size.

Step (1) Find the maximum load speed V .

Find the maximum load speed: V (mm/s) from the load movement time: t (s) and the movement distance: st (mm).

Graph (1)

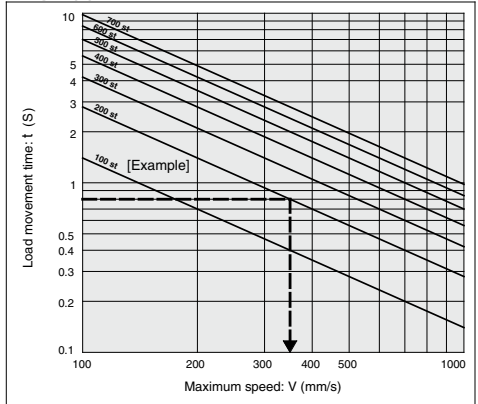

Step (2) Find the bore size.

Select a graph based upon the load condition and operating pressure, and then find the point of intersection for the maximum speed found in Step (1) and the load mass. Select the bore size on the above the point of intersection.

Load Condition

Operating Pressure

Load in the direction at the right angle to rod

(* Being held by a guide)

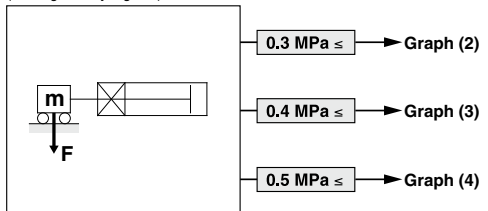

Load in the direction of rod extension
Load in the direction of rod retraction

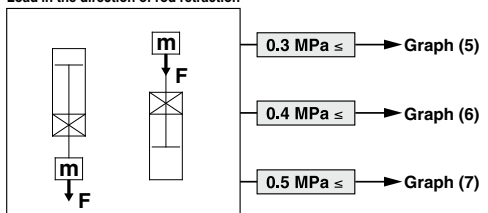

Selection Graph

Graph (2) $0.3 \text{ MPa} \leq P < 0.4 \text{ MPa}$

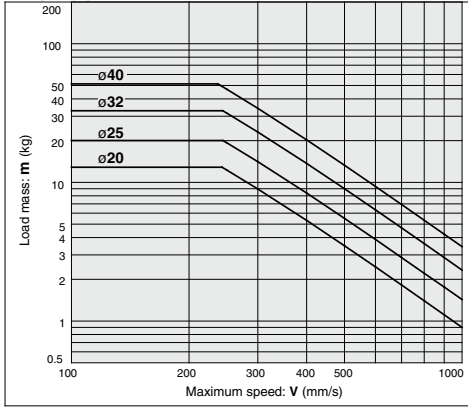

Graph (5) $0.3 \text{ MPa} \leq P < 0.4 \text{ MPa}$

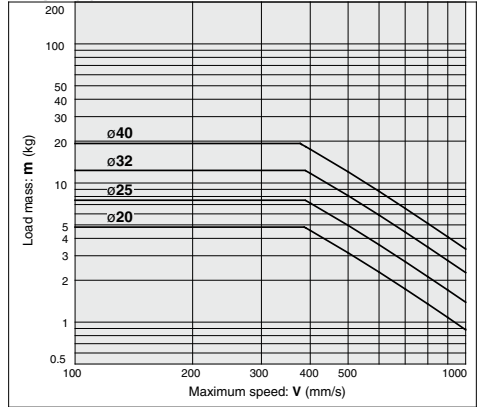

Graph (3) $0.4 \text{ MPa} \leq P < 0.5 \text{ MPa}$

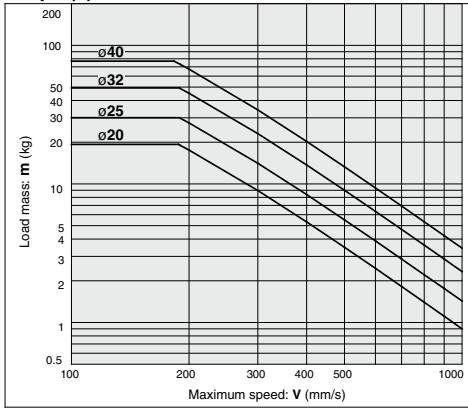

Graph (6) $0.4 \text{ MPa} \leq P < 0.5 \text{ MPa}$

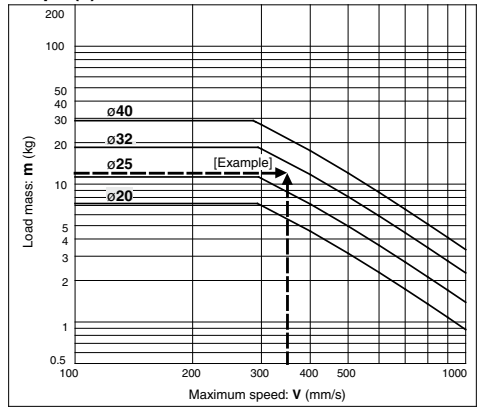

Graph (4) $0.5 \text{ MPa} \leq P$

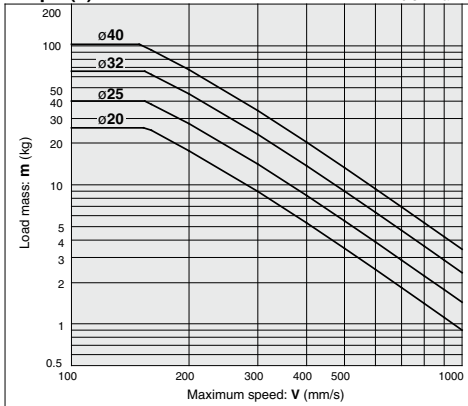

Graph (7) $0.5 \text{ MPa} \leq P$

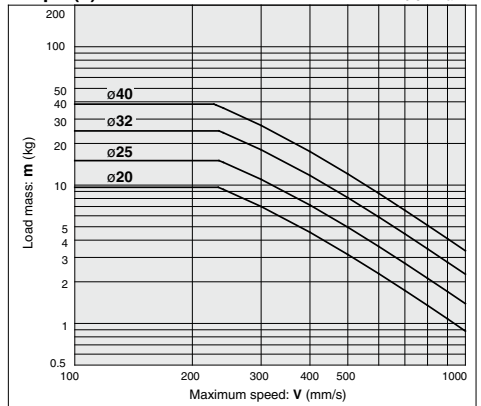

Cylinder with Lock

Double Acting, Single Rod

CNG Series

ø20, ø25, ø32, ø40



How to Order

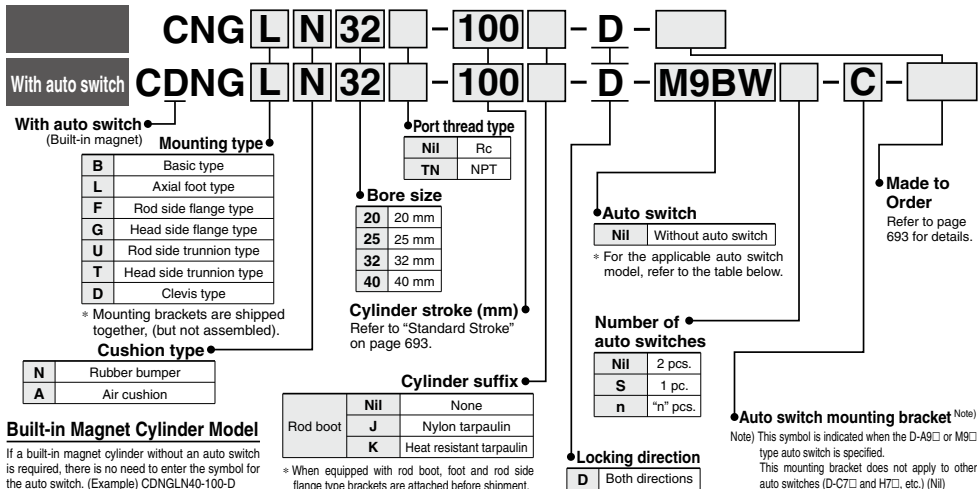

Built-in Magnet Cylinder Model

If a built-in magnet cylinder without an auto switch is required, there is no need to enter the symbol for the auto switch. (Example) CDNGLN40-100-D

* When equipped with rod boot, foot and rod side flange type brackets are attached before shipment.

Applicable Auto Switches

Refer to pages 1341 to 1435 for further information on auto switches.

Type	Special function	Electrical entry	Indicator light	Wiring (Output)	Load voltage		Auto switch model		Lead wire length (m)					Pre-wired connector	Applicable load				
					DC	AC	Applicable bore size		0.5 (Nil)	1 (M)	3 (L)	5 (Z)	None (N)						
							Perpendicular	In-line											
Solid state auto switch	—	Grommet	—	3-wire (NPN)	5 V, 12 V	—	M9NV	M9N	●	●	●	○	○	IC circuit					
				3-wire (PNP)			—	M9PV	M9P	●	●	●	○						
				2-wire			12 V	—	M9BV	M9B	●	●	●		○				
		Connector		Yes	3-wire (NPN)	24 V	5 V, 12 V	—	—	M9NVV	M9NV	●	●		●	○	IC circuit		
					3-wire (PNP)			—	—	M9PVV	M9PV	●	●		●	○			
					2-wire			12 V	—	M9BVV	M9BV	●	●		●	○			
	Diagnostic indication (2-color indicator)	Grommet	—	3-wire (NPN)	5 V, 12 V	—	M9NAV*1	M9NA*1	○	○	○	○	○	IC circuit					
				3-wire (PNP)			—	M9PAV*1	M9PA*1	○	○	○	○						
				2-wire			12 V	—	M9BAV*1	M9BA*1	○	○	○		○				
		Connector		Yes	4-wire (NPN)	5 V, 12 V	—	—	H7NF	—	●	●	●		○	IC circuit			
					3-wire (Equiv. to NPN)			—	A96V	A96	●	●	●		○				
					2-wire			24 V	12 V	A93V*2	A93	●	●		●		○		
Water resistant (2-color indicator)	Grommet	—	—	2-wire	24 V	12 V	A90V	A90	●	●	●	○	IC circuit						
							—	—	B54	●	●	●		○					
							—	—	B64	●	●	●		○					
	Connector						Yes	—	—	—	—	C73C		●	●	●	○	—	
								—	—	—	—	C80C		●	●	●	○		
								—	—	—	—	B59W		●	●	●	○		
Diagnostic output (2-color indicator)	Grommet	—	—	2-wire	24 V	12 V	—	—	●	●	●	○	IC circuit						
							—	—	—	—	—	—		—	—				
							—	—	—	—	—	—		—	—				
	Connector						Yes	—	—	—	—	—		—	●	●	●	○	—
								—	—	—	—	—		—	—	—			
								—	—	—	—	—		—	—	—			

*1 Water resistant type auto switches can be mounted on the above models, but in such case SMC cannot guarantee water resistance. A water-resistant type cylinder is recommended for use in an environment which requires water resistance. However, please contact SMC for water-resistant products of ø20 and ø25.
 *2 1 m type lead wire is only applicable to D-A93.
 * Lead wire length symbols: 0.5 m Nil (Example) M9NV 5 m Z (Example) M9NVZ * Solid state auto switches marked with "○" are produced upon receipt of order.
 1 m M (Example) M9NVM None N (Example) H7CN
 3 m L (Example) M9NVL

* Since there are other applicable auto switches than listed, refer to page 708 for details.
 * For details about auto switches with pre-wired connector, refer to pages 1410 and 1411.
 * D-A9□(V)/M9□(V)/M9□W(V)/M9□A(V) auto switches are shipped together (not assembled). (Only auto switch brackets are assembled at the time of shipment.)



Model

Series	Type	Lock operation
CNG	Non-lube	Spring locking

Cylinder Specifications

Bore size (mm)	20	25	32	40
Lubrication	Not required (Non-lube)			
Proof pressure	1.5 MPa			
Max. operating pressure	1.0 MPa			
Min. operating pressure	0.08 MPa			
Piston speed	50 to 1000mm/s *			
Ambient and fluid temperature	Without auto switch: -10 to 70°C (No freezing) With auto switch: -10 to 60°C (No freezing)			
Cushion	Rubber bumper, Air cushion			
Stroke length tolerance (mm)	Up to 1000 st: $^{+1.4}_0$, 1001 to 1500 st: $^{+1.8}_0$			
Mounting	Basic type, Axial foot type, Rod side flange type, Head side flange type, Rod side trunnion type, Head side trunnion type, Clevis type (used for 90° change of port position)			

* When the piston is locked, the load weight is limited by the mounting orientation and the operating pressure.

Lock Specifications

Bore size (mm)	20	25	32	40
Locking action	Spring locking (Exhaust locking)			
Unlocking pressure	0.20 MPa or more	0.25 MPa or more		
Lock starting pressure	0.15 MPa or less	0.20 MPa or less		
Operating pressure range	0.2 to 1.0 MPa		0.25 to 1.0 MPa	
Locking direction	Both directions			
Holding force (Max. static load) N*	215	335	550	860

* The holding force (max. static load) shows the maximum capability and does not show the normal holding capability. So, select an appropriate cylinder while referring to page 690.

Standard Stroke/ Refer to the minimum auto switch mounting stroke (page 706) for cylinders with an auto switch.

Bore size	Standard stroke ^{Note1)}		Manufacturable stroke
	(mm)		
20	25, 50, 75, 100, 125, 150, 200		1500
25			
32			
40	25, 50, 75, 100, 125, 150, 200, 250, 300		
50, 63			
80			
100			

Note 1) Intermediate strokes not listed above are produced upon receipt of order. Manufacture of intermediate strokes at 1 mm intervals is possible. (Spacers are not used.)

Note 2) Applicable strokes should be confirmed according to the usage. For details, refer to "Air Cylinders Model Selection" in the **Web Catalog**. In addition, the products that exceed the standard stroke might not be able to fulfill the specifications due to the deflection etc.

Stopping Accuracy

Lock type	Piston speed (mm/s)			
	100	300	500	1000
Spring locking	± 0.3	± 0.6	± 1.0	± 2.0

Condition: Lateral, Supply pressure P = 0.5 MPa

Load mass Upper limit of allowed value

Solenoid valve for locking: Mounted directly to unlocking port

Maximum value of stopping position dispersion from 100 measurements



Symbol

Rubber bumper

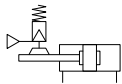

Air cushion

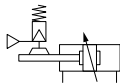

Made to Order Specifications

[Click here for details](#)

Symbol	Specifications
-XA□	Change of rod end shape
-XC4*	With heavy duty scraper
-XC35	With coil scraper

* -XC4 (with heavy duty scraper) is available only for ø32 and ø40.

Rod Boot Material

Symbol	Rod boot material	Max. operating temperature
J	Nylon tarpaulin	70°C
K	Heat resistant tarpaulin	110°C *

* Maximum ambient temperature for the rod boot itself.

Refer to pages 705 to 708 for cylinders with auto switches.

- Minimum auto switch mounting stroke
- Proper auto switch mounting position (detection at stroke end) and mounting height
- Operating range
- Switch mounting bracket: Part no.

CNG Series

Mounting Bracket Part No.

Mounting bracket	Bore size (mm)			
	20	25	32	40
Axial foot *	CNG-L020	CNG-L025	CNG-L032	CNG-L040
Flange	CNG-F020	CNG-F025	CNG-F032	CNG-F040
Trunnion pin	CG-T020	CG-T025	CG-T032	CG-T040
Clevis **	CG-D020	CG-D025	CG-D032	CG-D040
Rod side pivot bracket	CNG-020-24	CNG-025-24	CNG-032-24	CNG-040-24
Head side pivot bracket	CG-020-24A	CG-025-24A	CG-032-24A	CG-040-24A

* When ordering foot bracket, order 2 pieces per cylinder.

** Clevis pin, retaining ring, and mounting bolt are shipped together with clevis type.

*** Mounting bolts are included with the foot and flange types.

Accessory

Mounting		Basic type	Axial foot type	Rod side flange type	Head side flange type	Rod side trunnion type	Head side trunnion type	Clevis type
Standard equipment	Rod end nut	●	●	●	●	●	●	●
	Clevis pin	—	—	—	—	—	—	●
Option	Single knuckle joint	●	●	●	●	●	●	●
	Double knuckle joint (with pin) *	●	●	●	●	●	●	●
	Pivot bracket	—	—	—	—	●	●	●
	Rod boot	●	●	●	●	●	●	●

* Pins and retaining rings are attached with double knuckle joint.

* For details about part numbers and dimensions, refer to page 704. (For rod boots, refer to page 696.)

Weight

Bore size (mm)		20	25	32	40
Basic weight	Basic type	0.52	0.83	0.91	1.24
	Axial foot type	0.63	0.96	1.07	1.46
	Flange type	0.64	1.01	1.08	1.47
	Trunnion type	0.53	0.85	0.94	1.29
	Clevis type	0.57	0.91	1.06	1.47
Rod side pivot bracket		0.11	0.13	0.20	0.27
Head side pivot bracket		0.08	0.09	0.17	0.25
Single knuckle joint		0.05	0.09	0.09	0.10
Double knuckle joint (with pin)		0.05	0.09	0.09	0.13
Additional weight per each 50 mm of stroke		0.05	0.07	0.09	0.15
Additional weight with air cushion		0.01	0.01	0.02	0.02
Additional weight for long stroke		0.01	0.01	0.02	0.03

Calculation: (Example) **CNGLA20-100-D** (Foot type, ø20, 100 st)

Basic weight 0.63 kg (Foot type, ø20)

Additional weight 0.05 kg/50 st

Air cylinder stroke 100 st

Air cushion additional weight 0.01 kg

$0.63 + 0.05 \times 100/50 + 0.01 = 0.74$ kg

Construction Principle

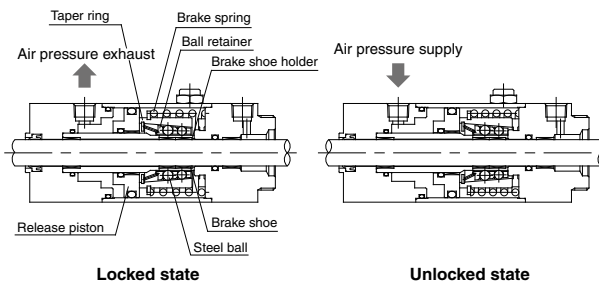

Spring locking (Exhaust locking)

The spring force which acts upon the taper ring is magnified by a wedge effect, and is conveyed to all of the numerous steel balls which are arranged in two circles. These act on the brake shoe holder and brake, which locks the piston rod by tightening against it with a large force.

Unlocking is accomplished when air pressure is supplied to the unlocking port. The release piston and taper ring oppose the spring force, moving to the right side, and the ball retainer strikes the cover section. The braking force is released as the steel balls are removed from the taper ring by the ball retainer.

Construction

With rubber bumper: CNGBN

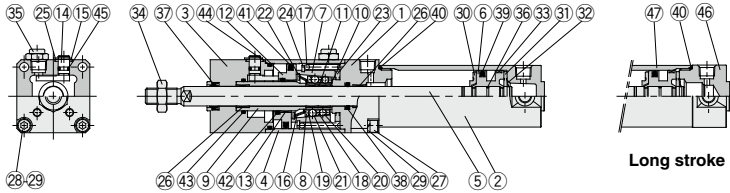

With air cushion: CNGBA

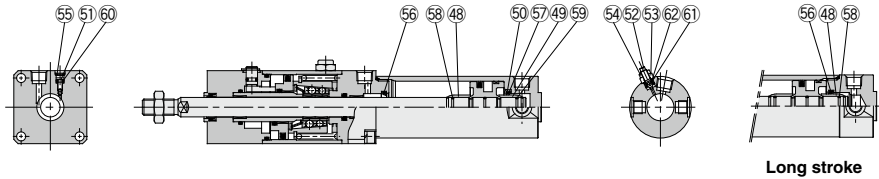

Component Parts

No.	Description	Material	Note
1	Rod cover	Aluminum alloy	Anodized
2	Tube cover	Aluminum alloy	Hard anodized
3	Cover	Aluminum alloy	Anodized
4	Intermediate cover	Aluminum alloy	Anodized
5	Piston rod	Carbon steel*	Hard chrome plated
6	Piston	Aluminum alloy	
7	Taper ring	Carbon steel	Heat treated
8	Ball retainer	Special resin	
9	Piston guide	Carbon steel	Trivalent zinc chromated
10	Brake shoe holder	Special steel	Heat treated
11	Brake shoe	Special friction material	
12	Release piston	Carbon steel	Zinc chromated
13	Release piston bushing	Bearing alloy	
14	Unlocking cam	Chromium molybdenum steel	Electroless nickel plated
15	Washer	Rolled steel plate	Electroless nickel plated
16	Retainer pre-load spring	Steel wire	Trivalent zinc chromated
17	Brake spring	Steel wire	Trivalent zinc chromated
18	Clip A	Stainless steel	ø25, ø32 only
19	Clip B	Stainless steel	ø25, ø32 only
20	Steel ball A	Carbon steel	
21	Steel ball B	Carbon steel	
22	Tooth ring	Stainless steel	
23	Bumper	Resin	
24	Type C retaining ring for taper ring	Carbon steel	
25	Type C retaining ring for unlocking cam shaft	Carbon steel	
26	Bushing	Bearing alloy	
27	Hexagon socket head cap screw	Chromium molybdenum steel	
28	Hexagon socket head cap screw	Chromium molybdenum steel	
29	Spring washer for hex. socket head cap screw	Steel wire	
30	Bumper A	Resin	
31	Bumper B	Resin	ø40 is the same as bumper A
32	Retaining ring	Stainless steel	
33	Wear ring	Resin	
34	Rod end nut	Carbon steel	Trivalent zinc chromated
35	BC element	Bronze	
36	Piston gasket	NBR	

Note) In the case of cylinders with auto switches, magnets are installed on the piston.

* The material for ø20 and ø25 cylinders equipped with auto switches is stainless steel.

Component Parts

No.	Description	Material	Note
37	Rod seal A	NBR	
38	Rod seal B	NBR	
39	Piston seal	NBR	
40	Cylinder tube gasket	NBR	
41	Release piston seal	NBR	
42	Rod seal C	NBR	
43	Piston guide gasket	NBR	
44	Intermediate cover gasket	NBR	
45	Unlocking cam gasket	NBR	
46	Head cover	Aluminum alloy	Anodized
47	Cylinder tube	Aluminum alloy	Hard anodized
48	Cushion ring A	Aluminum alloy	Anodized
49	Cushion ring B	Aluminum alloy	Same anodized as cushion ring A except ø20, 25 standard stroke
50	Seal retainer	Rolled steel	Zinc chromated (ørg strokes not available)
51	Cushion valve A	Chromium molybdenum steel	Electroless nickel plated
52	Cushion valve B	Rolled steel	Electroless nickel plated
53	Valve retainer	Rolled steel	Electroless nickel plated
54	Lock nut	Rolled steel	
55	Retaining ring	Stainless steel	
56	Cushion seal A	Urethane	
57	Cushion seal B	Urethane	Same as cushion seal A except ø20, 25 standard stroke
58	Cushion ring gasket A	NBR	
59	Cushion ring gasket B	NBR	Same as cushion ring gasket A except ø20, 25 standard stroke
60	Valve seal A	NBR	
61	Valve seal B	NBR	
62	Valve retainer gasket	NBR	

Replacement Parts: Seal Kit

Bore size (mm)	Kit no.	Contents
20	CG1N20-PS	Set of above nos. 37, 39, 40
25	CG1N25-PS	
32	CG1N32-PS	
40	CG1N40-PS	

* Since the lock section for the CNG series is normally replaced as a unit, kits are for the cylinder section only. These can be ordered using the order number for each bore size.

* Seal kit includes a grease pack (10 g). Order with the following part number when only the grease pack is needed. **Grease pack part number: GR-S-010** (10 g)

CNG Series

Dimensions

Basic type (B): With rubber bumper CNGBN

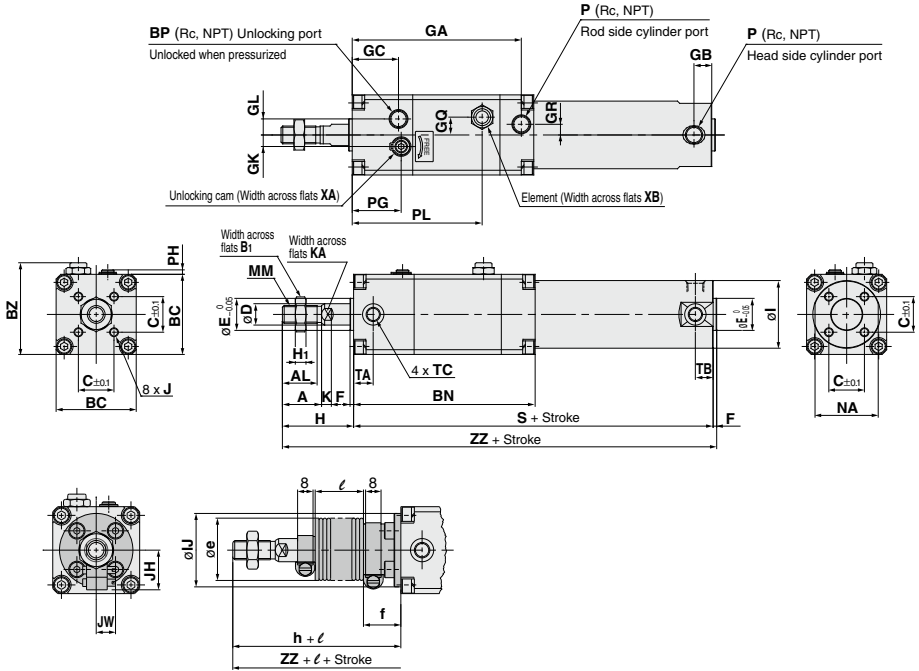

With rod boot

Bore size (mm)	Stroke range without rod boot		Stroke range with rod boot		A	AL	B ₁	BC	BN	BP	BZ	C	D	E	F	GA	GB	GC	GK	GL	GR	GQ	H ₁	I
	Standard	Long stroke	Standard	Long stroke																				
20	Up to 200	201 to 1500	20 to 200	201 to 1500	18	15.5	13	38	93	1/8	44.5	14	8	12	2	85	10 (12)	18	5.5	6	4	8	5	26
25	Up to 300	301 to 1500	20 to 300	301 to 1500	22	19.5	17	45	103	1/8	51.5	16.5	10	14	2	96	10 (12)	25	6.5	9	7	10	6	31
32	Up to 300	301 to 1500	20 to 300	301 to 1500	22	19.5	17	45	104	1/8	51.5	20	12	18	2	104	10 (12)	25	6.5	9	7	10	6	38
40	Up to 300	301 to 1500	20 to 300	301 to 1500	30	27	19	52	112	1/8	58.5	26	16	25	2	104	10 (13)	26	7	11	7	12	8	47

(mm)

Bore size (mm)	J	K	KA	MM	NA	P	PG	PH	PL	S	TA	TB	TC	XA	XB	Without rod boot	
																H	ZZ
20	M4 x 0.7 depth 7	5	6	M8 x 1.25	24	1/8	21.5	2	65	141 (149)	11	11	M5 x 0.8	3	12	35	178 (186)
25	M5 x 0.8 depth 7.5	5.5	8	M10 x 1.25	29	1/8	26.5	2.5	73	151 (159)	11	11	M6 x 0.75	3	12	40	193 (201)
32	M5 x 0.8 depth 8	5.5	10	M10 x 1.25	35.5	1/8	26.5	2.5	73	154 (162)	11	10 (11)	M8 x 1.0	3	12	40	196 (204)
40	M6 x 1 depth 12	6	14	M14 x 1.5	44	1/8	28	2.5	81	169 (176)	12	10 (12)	M10 x 1.25	4	12	50	221 (230)

(mm)

Bore size (mm)	With rod boot							
	IJ	JH (Reference)	JW (Reference)	e	f	h	ℓ	ZZ
20	27	15.5	10.5	30	18	55	1/4 stroke	198 (206)
25	32	16.5	10.5	30	19	62		215 (223)
32	38	18.5	10.5	35	19	62		218 (226)
40	48	21.5	10.5	35	19	70		241 (250)

Note () : Denotes the dimensions for long stroke.

Basic type (B): With air cushion CNGBA

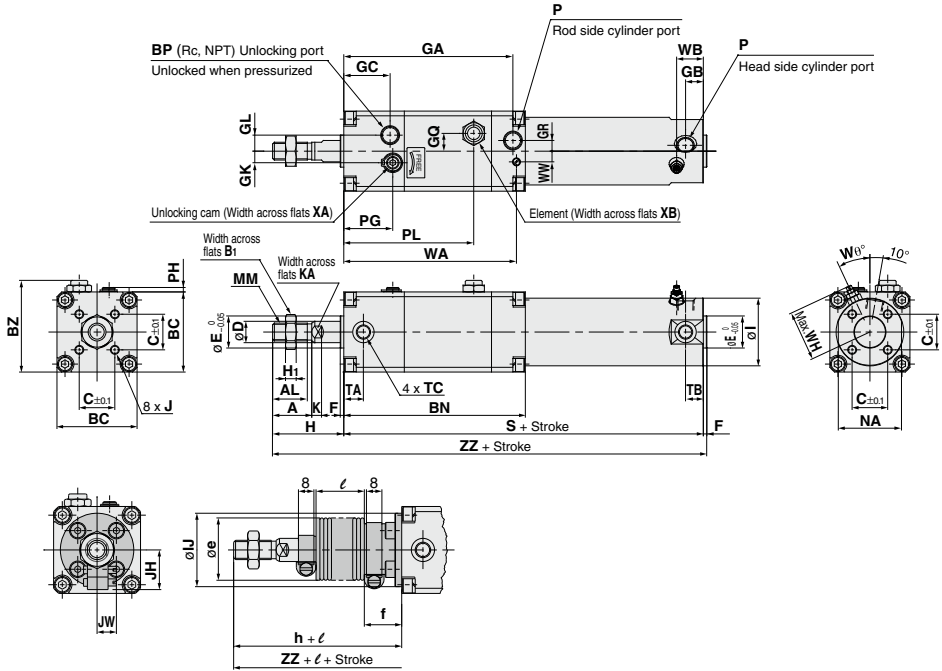

With rod boot

Bore size (mm)	Stroke range without rod boot		Stroke range with rod boot		A	AL	B ₁	BC	BN	BP	BZ	C	D	E	F	GA	GB	GC	GK	GL	GR	GQ	H ₁	I
	Standard	Long stroke	Standard	Long stroke																				
20	Up to 200	201 to 1500	20 to 200	201 to 1500	18	15.5	13	38	93	1/8	44.5	14	8	12	2	87	10 (12)	18	5.5	6	4	8	5	26
25	Up to 300	301 to 1500	20 to 300	301 to 1500	22	19.5	17	45	103	1/8	51.5	16.5	10	14	2	97	10 (12)	25	6.5	9	7	10	6	31
32	Up to 300	301 to 1500	20 to 300	301 to 1500	22	19.5	17	45	104	1/8	51.5	20	12	18	2	97	10 (12)	25	6.5	9	7	10	6	38
40	Up to 300	301 to 1500	20 to 300	301 to 1500	30	27	19	52	112	1/8	58.5	26	16	25	2	104	10 (13)	26	7	11	7	12	8	47

Bore size (mm)	J	K	KA	MM	NA	P	PG	PH	PL	S	TA	TB	TC	WA	WB	WH	WW	Wθ	XA	XB
20	M4 x 0.7 depth 7	5	6	M8 x 1.25	24	M5 x 0.8	21.5	2	65	141 (149)	11	11	M5 x 0.8	88	15 (16)	23	5.5	30°	3	12
25	M5 x 0.8 depth 7.5	5.5	8	M10 x 1.25	29	M5 x 0.8	26.5	2.5	73	151 (159)	11	11	M6 x 0.75	98	15 (16)	25	6	30°	3	12
32	M5 x 0.8 depth 8	5.5	10	M10 x 1.25	35.5	Rc 1/8	26.5	2.5	73	154 (162)	11	10 (11)	M8 x 1.0	99	15 (16)	28.5	6	25°	3	12
40	M6 x 1 depth 12	6	14	M14 x 1.5	44	Rc 1/8	28	2.5	81	169 (178)	12	10 (12)	M10 x 1.25	107	15 (16)	33	8	20°	4	12

Bore size (mm)	Without rod boot		With rod boot							
	H	ZZ	IJ	JH (Reference)	JW (Reference)	e	f	h	ℓ	ZZ
20	35	178 (186)	27	15.5	10.5	30	18	55	1/4 stroke	198 (206)
25	40	193 (201)	32	16.5	10.5	30	19	62		215 (223)
32	40	196 (204)	38	18.5	10.5	35	19	62		218 (226)
40	50	221 (230)	48	21.5	10.5	35	19	70		241 (250)

Note () : Denotes the dimensions for long stroke.
Dimensions with mounting bracket are the same as dimensions with rubber bumper.

CNG Series

Dimensions

Axial foot type (L): With rubber bumper CNGLN

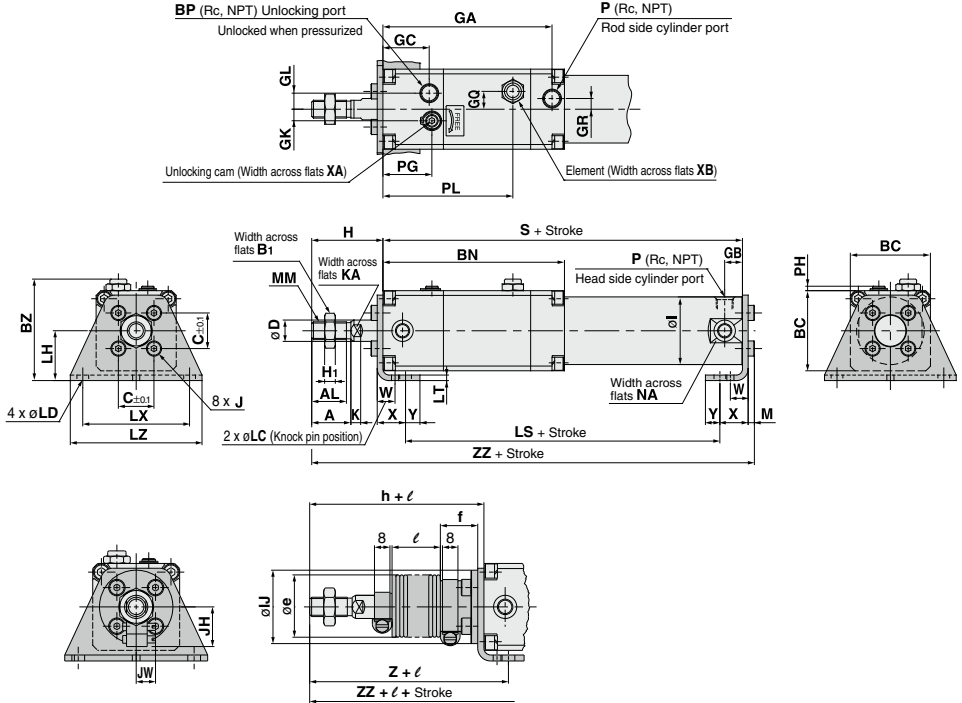

With rod boot

Bore size (mm)	Stroke range without rod boot		Stroke range with rod boot		A	AL	B1	BC	BN	BP	BZ	C	D	GA	GB	GC	GK	GL	GR	GQ	H ₁	I	J
	Standard	Long stroke	Standard	Long stroke																			
20	Up to 200	201 to 1500	20 to 200	201 to 1500	18	15.5	13	38	93	1/8	50.5	14	8	85	10 (12)	18	5.5	6	4	8	5	26	M4 x 0.7
25	Up to 300	301 to 1500	20 to 300	301 to 1500	22	19.5	17	45	103	1/8	57	16.5	10	96	10 (12)	25	6.5	9	7	10	6	31	M5 x 0.8
32	Up to 300	301 to 1500	20 to 300	301 to 1500	22	19.5	17	45	104	1/8	57	20	12	97	10 (12)	25	6.5	9	7	10	6	38	M5 x 0.8
40	Up to 300	301 to 1500	20 to 300	301 to 1500	30	27	19	52	112	1/8	65.5	26	16	104	10 (13)	26	7	11	7	12	8	47	M6 x 1

Bore size (mm)	K	KA	M	MM	NA	P	PG	PH	PL	S	LC	LD	LH	LS	LT	LX	LZ	X	Y	W	XA	XB
	20	5	6	3	M8 x 1.25	24	1/8	21.5	2	65	141 (149)	4	6	25	117 (125)	3	50	62	15	7	10	3
25	5.5	8	3.5	M10 x 1.25	29	1/8	26.5	2.5	73	151 (159)	4	6	28	127 (135)	3	57	70	15	7	10	3	12
32	5.5	10	3.5	M10 x 1.25	35.5	1/8	26.5	2.5	73	154 (162)	4	7	28	128 (136)	3	60	74	16	8	10	3	12
40	6	14	4	M14 x 1.5	44	1/8	28	2.5	81	169 (178)	4	7	33	142 (151)	3	68	84	16.5	8.5	10	4	12

Bore size (mm)	Without rod boot			With rod boot							
	H	ZZ	IJ	JH (Reference)	JW (Reference)	e	f	h	l	Z	ZZ
20	35	182 (190)	27	15.5	10.5	30	18	55	1/4 stroke	67	202 (210)
25	40	197.5 (205.5)	32	16.5	10.5	30	19	62		74	219.5 (227.5)
32	40	200.5 (208.5)	38	18.5	10.5	35	19	62		75	222.5 (230.5)
40	50	226 (235)	48	21.5	10.5	35	19	70		83.5	246 (255)

Note () : Denotes the dimensions for long stroke.

Rod side flange type (F): With rubber bumper CNGFN

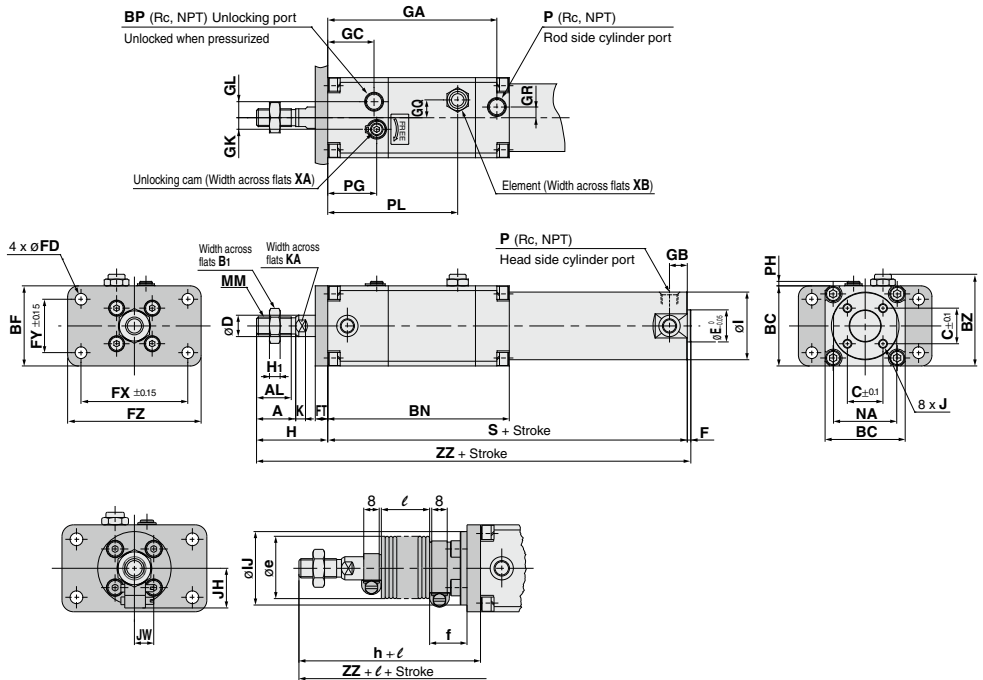

With rod boot

Bore size (mm)	Stroke range without rod boot		Stroke range with rod boot		A	AL	B ₁	BC	BF	BN	BP	BZ	C	D	E	F	GA	GB	GC	GK	GL	GR	GQ	H ₁
	Standard	Long stroke	Standard	Long stroke																				
20	Up to 200	201 to 1500	20 to 200	201 to 1500	18	15.5	13	38	38	93	1/8	44.5	14	8	12	2	85	10 (12)	18	5.5	6	4	8	5
25	Up to 300	301 to 1500	20 to 300	301 to 1500	22	19.5	17	45	45	103	1/8	51.5	16.5	10	14	2	96	10 (12)	25	6.5	9	7	10	6
32	Up to 300	301 to 1500	20 to 300	301 to 1500	22	19.5	17	45	45	104	1/8	51.5	20	12	18	2	97	10 (12)	25	6.5	9	7	10	6
40	Up to 300	301 to 1500	20 to 300	301 to 1500	30	27	19	52	52	112	1/8	58.5	26	16	25	2	104	10 (13)	26	7	11	7	12	8

Bore size (mm)	I	J	K	KA	MM	NA	P	PG	PH	PL	S	FD	FT	FX	FY	FZ	XA	XB	Without rod boot	
																			H	ZZ
20	26	M4 x 0.7	5	6	M8 x 1.25	24	1/8	21.5	2	65	141 (149)	5.5	6	52	25	65	3	12	35	178 (186)
25	31	M5 x 0.8	5.5	8	M10 x 1.25	29	1/8	26.5	2.5	73	151 (159)	5.5	7	60	30	75	3	12	40	193 (201)
32	38	M5 x 0.8	5.5	10	M10 x 1.25	35.5	1/8	26.5	2.5	73	154 (162)	6.6	7	60	30	75	3	12	40	196 (204)
40	47	M6 x 1	6	14	M14 x 1.5	44	1/8	28	2.5	81	169 (178)	6.6	8	66	36	82	4	12	50	221 (230)

Bore size (mm)	With rod boot						
	IJ	JH (Reference)	JW (Reference)	e	f	h	ℓ
20	27	15.5	10.5	30	18	55	198 (206)
25	32	16.5	10.5	30	19	62	215 (223)
32	38	18.5	10.5	35	19	62	218 (226)
40	48	21.5	10.5	35	19	70	241 (250)

Note) (): Denotes the dimensions for long stroke.

CNG Series

Dimensions

Head side flange type (G): With rubber bumper CNGGN

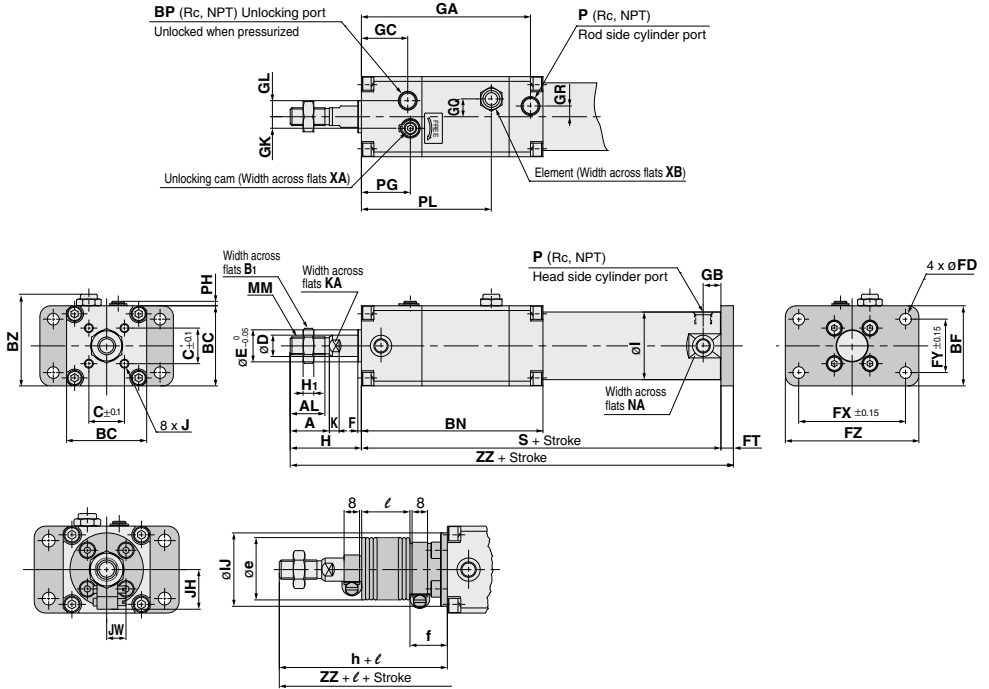

With rod boot

Bore size (mm)	Stroke range without rod boot		Stroke range with rod boot																						
	Standard	Long stroke	Standard	Long stroke	A	AL	B ₁	BC	BF	BN	BP	BZ	C	D	E	F	GA	GB	GC	GK	GL	GR	GQ	H ₁	I
20	Up to 200	201 to 1500	20 to 200	201 to 1500	18	15.5	13	38	38	93	1/8	44.5	14	8	12	2	85	10 (12)	18	5.5	6	4	8	5	26
25	Up to 300	301 to 1500	20 to 300	301 to 1500	22	19.5	17	45	45	103	1/8	51.5	16.5	10	14	2	96	10 (12)	25	6.5	9	7	10	6	31
32	Up to 300	301 to 1500	20 to 300	301 to 1500	22	19.5	17	45	45	104	1/8	51.5	20	12	18	2	97	10 (12)	25	6.5	9	7	10	6	38
40	Up to 300	301 to 1500	20 to 300	301 to 1500	30	27	19	52	52	112	1/8	58.5	26	16	25	2	104	10 (13)	26	7	11	7	12	8	47

Bore size (mm)																			
	J	K	KA	MM	NA	P	PG	PH	PL	S	FD	FT	FX	FY	FZ	XA	XB	Without rod boot	Without rod boot
(mm)	H	ZZ																	
20	M4 x 0.7	5	6	M8 x 1.25	24	1/8	21.5	2	65	141 (149)	5.5	6	52	25	65	3	12	35	182 (190)
25	M5 x 0.8	5.5	8	M10 x 1.25	29	1/8	26.5	2.5	73	151 (159)	5.5	7	60	30	75	3	12	40	198 (206)
32	M5 x 0.8	5.5	10	M10 x 1.25	35.5	1/8	26.5	2.5	73	154 (162)	6.6	7	60	30	75	3	12	40	201 (209)
40	M6 x 1	6	14	M14 x 1.5	44	1/8	28	2.5	81	169 (178)	6.6	8	66	36	82	4	12	50	227 (236)

Bore size (mm)	With rod boot							ZZ
	IJ	JH (Reference)	JW (Reference)	e	f	h	ℓ	
20	27	15.5	10.5	30	18	55	202 (210)	
25	32	16.5	10.5	30	19	62	220 (228)	
32	38	18.5	10.5	35	19	62	223 (231)	
40	48	21.5	10.5	35	19	70	247 (256)	

Note) () : Denotes the dimensions for long stroke.

Rod side trunnion type (U): With rubber bumper CNGUN

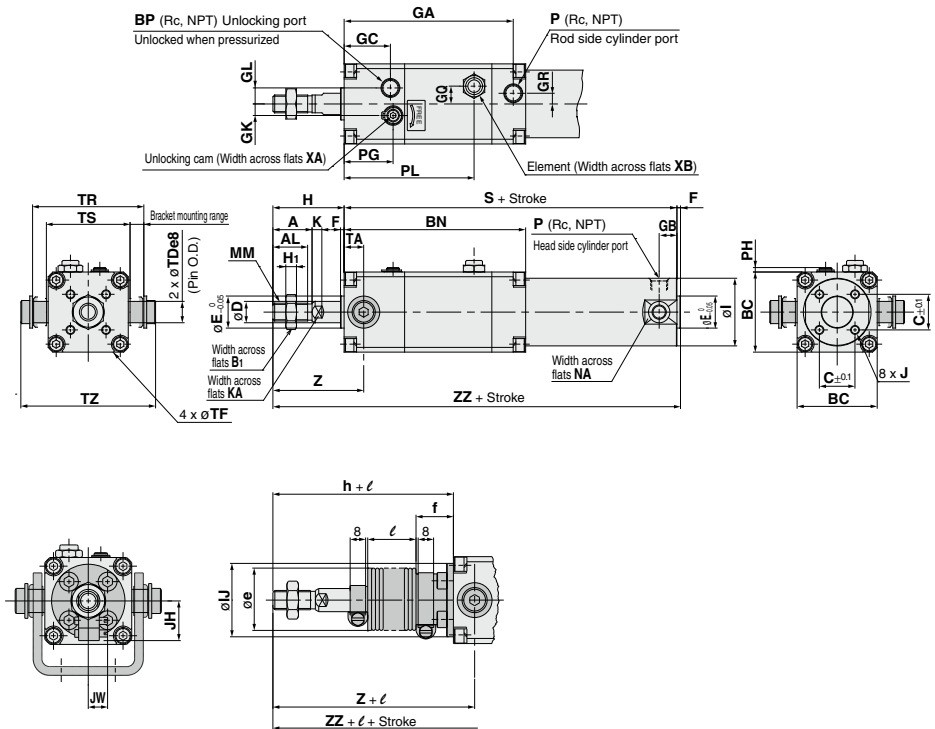

With rod boot

Bore size (mm)	Stroke range without rod boot		Stroke range with rod boot		A	AL	B ₁	BC	BN	BP	C	D	E	F	GA	GB	GC	GK	GL	GR	GQ	H	I
	Standard	Long stroke	Standard	Long stroke																			
20	Up to 200	201 to 1500	20 to 200	201 to 1500	18	15.5	13	38	93	1/8	14	8	12	2	85	10 (12)	18	5.5	6	4	8	5	26
25	Up to 300	301 to 1500	20 to 300	301 to 1500	22	19.5	17	45	103	1/8	16.5	10	14	2	96	10 (12)	25	6.5	9	7	10	6	31
32	Up to 300	301 to 1500	20 to 300	301 to 1500	22	19.5	17	45	104	1/8	20	12	18	2	97	10 (12)	25	6.5	9	7	10	6	38
40	Up to 300	301 to 1500	20 to 300	301 to 1500	30	27	19	52	112	1/8	26	16	25	2	104	10 (13)	26	7	11	7	12	8	47

Bore size (mm)	J	K	KA	MM	NA	P	PG	PH	PL	S	TA	TDe8	TR	TS	TZ	XA	XB
	20	M4 x 0.7	5	6	M8 x 1.25	24	1/8	21.5	2	65	141 (149)	11	8 ^{-0.025} _{-0.047}	51	40	59.6	3
25	M5 x 0.8	5.5	8	M10 x 1.25	29	1/8	26.5	2.5	73	151 (159)	11	10 ^{-0.025} _{-0.047}	58	47	68	3	12
32	M5 x 0.8	5.5	10	M10 x 1.25	35.5	1/8	26.5	2.5	73	154 (162)	11	12 ^{-0.032} _{-0.059}	62.5	47	75.7	3	12
40	M6 x 1	6	14	M14 x 1.5	44	1/8	28	2.5	81	169 (178)	12	14 ^{-0.032} _{-0.059}	72.5	54	85.7	4	12

Bore size (mm)	Without rod boot			With rod boot							
	H	Z	ZZ	IJ	JH (Reference)	JW (Reference)	e	f	h	ℓ	Z
20	35	46	178 (186)	27	15.5	10.5	30	18	55	66	198 (206)
25	40	51	193 (201)	32	16.5	10.5	30	19	62	73	215 (223)
32	40	51	196 (204)	38	18.5	10.5	35	19	62	73	218 (226)
40	50	62	221 (230)	48	21.5	10.5	35	19	70	82	241 (250)

Note (): Denotes the dimensions for long stroke.
For the pivot bracket, refer to page 704.

CNG Series

Dimensions

Head side trunnion type (T): With rubber bumper CNGTN

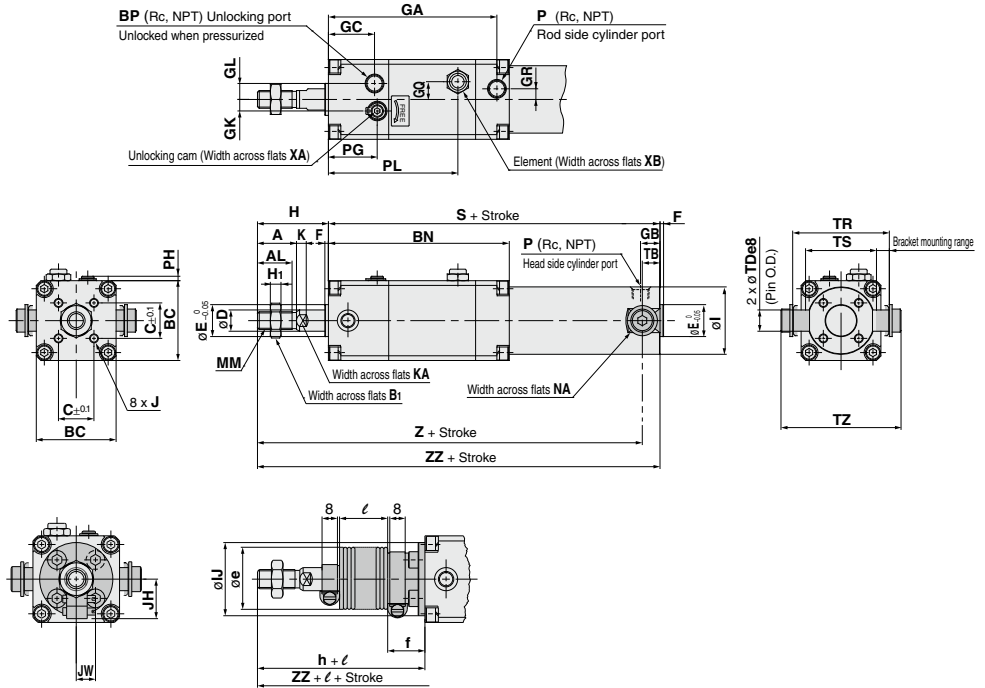

With rod boot

Bore size (mm)	Stroke range without rod boot		Stroke range with rod boot		A	AL	B ₁	BC	BN	BP	C	D	E	F	GA	GB	GC	GL	GR	GQ	H ₁	I	
	Standard	Long stroke	Standard	Long stroke																			
20	Up to 200	201 to 1500	20 to 200	201 to 1500	18	15.5	13	38	93	1/8	14	8	12	2	85	10 (12)	18	5.5	6	4	8	5	26
25	Up to 300	301 to 1500	20 to 300	301 to 1500	22	19.5	17	45	103	1/8	16.5	10	14	2	96	10 (12)	25	6.5	9	7	10	6	31
32	Up to 300	301 to 1500	20 to 300	301 to 1500	22	19.5	17	45	104	1/8	20	12	18	2	97	10 (12)	25	6.5	9	7	10	6	38
40	Up to 300	301 to 1500	20 to 300	301 to 1500	30	27	19	52	112	1/8	26	16	25	2	104	10 (13)	26	7	11	7	12	8	47

Bore size (mm)	J	K	KA	MM	NA	P	PG	PH	PL	S	TB	TDe8	TR	TS	TZ	XA	XB
20	M4x0.7	5	6	M8x1.25	24	1/8	21.5	2	65	141 (149)	11	8 ^{-0.025} _{-0.047}	39	28	47.6	3	12
25	M5x0.8	5.5	8	M10x1.25	29	1/8	26.5	2.5	73	151 (159)	11	10 ^{-0.025} _{-0.047}	43	33	53	3	12
32	M5x0.8	5.5	10	M10x1.25	35.5	1/8	26.5	2.5	73	154 (162)	10(11)	12 ^{-0.032} _{-0.059}	54.5	40	67.7	3	12
40	M6x1	6	14	M14x1.5	44	1/8	28	2.5	81	169 (178)	10(12)	14 ^{-0.032} _{-0.059}	65.5	49	78.7	4	12

Bore size (mm)	Without rod boot			With rod boot									
	H	Z	ZZ	IJ	JH (Reference)	JW (Reference)	e	f	h	ℓ	Z	ZZ	
20	35	165 (173)	178 (186)	27	15.5	10.5	30	18	55		185 (193)	198 (206)	
25	40	180 (188)	193 (201)	32	16.5	10.5	30	19	62	1/4 stroke	202 (210)	215 (223)	
32	40	184 (192)	196 (204)	38	18.5	10.5	35	19	62		206 (214)	218 (226)	
40	50	209 (216)	221 (230)	48	21.5	10.5	35	19	70		229 (236)	241 (250)	

Note () : Denotes the dimensions for long stroke.
For the pivot bracket, refer to page 704.

Clevis type (D): With rubber bumper CNGDN

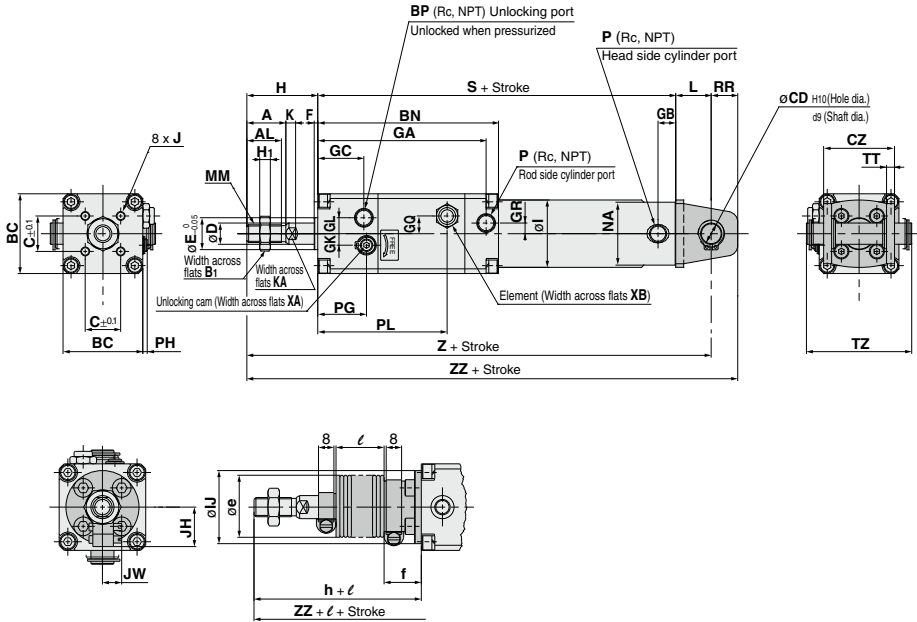

With rod boot

(mm)

Bore size (mm)	Stroke range without rod boot		Stroke range with rod boot		A	AL	B ₁	BC	BN	BP	C	D	E	F	GA	GB	GC	GK	GL	GR	GQ	H	I
	Standard	Long stroke	Standard	Long stroke																			
20	Up to 200	201 to 1500	20 to 200	201 to 1500	18	15.5	13	38	93	1/8	14	8	12	2	85	10 (12)	18	5.5	6	4	8	5	26
25	Up to 300	301 to 1500	20 to 300	301 to 1500	22	19.5	17	45	103	1/8	16.5	10	14	2	96	10 (12)	25	6.5	9	7	10	6	31
32	Up to 300	301 to 1500	20 to 300	301 to 1500	22	19.5	17	45	104	1/8	20	12	18	2	97	10 (12)	25	6.5	9	7	10	6	38
40	Up to 300	301 to 1500	20 to 300	301 to 1500	30	27	19	52	112	1/8	26	16	25	2	104	10 (13)	26	7	11	7	12	8	47

(mm)

Bore size (mm)	J	K	KA	MM	NA	P	PG	PH	PL	S	CD	CZ	L	RR	TT	TZ	XA	XB
20	M4x0.7	5	6	M8x1.25	24	1/8	21.5	2	65	141 (149)	8	29	14	11	3.2	43.4	3	12
25	M5x0.8	5.5	8	M10x1.25	29	1/8	26.5	2.5	73	151 (159)	10	33	16	13	3.2	48	3	12
32	M5x0.8	5.5	10	M10x1.25	35.5	1/8	26.5	2.5	73	154 (162)	12	40	20	15	4.5	59.4	3	12
40	M6x1	6	14	M14x1.5	44	1/8	28	2.5	81	169 (178)	14	49	22	18	4.5	71.4	4	12

(mm)

Bore size (mm)	Without rod boot			With rod boot									
	H	Z	ZZ	IJ	JH (Reference)	JW (Reference)	e	f	h	ℓ	Z	ZZ	
20	35	190 (198)	201 (209)	27	15.5	10.5	30	18	55	1/4 stroke	210 (218)	221 (229)	
25	40	207 (215)	220 (228)	32	16.5	10.5	30	19	62		229 (237)	242 (250)	
32	40	214 (222)	229 (237)	38	18.5	10.5	35	19	62		236 (244)	251 (259)	
40	50	241 (250)	259 (268)	48	21.5	10.5	35	19	70		261 (270)	279 (288)	

Note () : Denotes the dimensions for long stroke.
Clevis pin and retaining ring are attached.
For the pivot bracket, refer to page 704.

Accessory Bracket Dimensions

Single Knuckle Joint

I-G02/G03

Material: Rolled steel

I-G04

Material: Cast iron

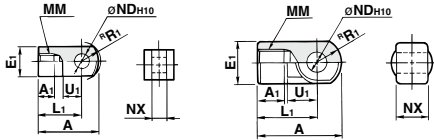

(mm)

Part no.	Applicable bore size (mm)	A	A1	E1	L1	MM	R1	U1	NDH10	NX
I-G02	20	34	8.5	16	25	M8 x 1.25	10.3	11.5	8 ^{+0.058} ₀	8 ^{-0.2} ₀
I-G03	25, 32	41	10.5	20	30	M10 x 1.25	12.8	14	10 ^{+0.058} ₀	10 ^{-0.2} ₀
I-G04	40	42	14	22	30	M14 x 1.5	12	14	10 ^{+0.058} ₀	18 ^{-0.2} ₀

Rod Side Pivot Bracket

ø20 to ø40

Material: Rolled steel

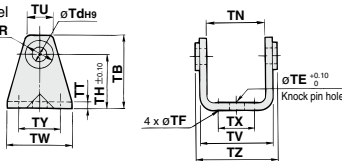

(mm)

Part no.	Applicable bore size (mm)	TB	TdH9	TE	TF	TH	TN
CNG-020-24	20	42	8 ^{+0.036} ₀	10	5.5	31	(41.4)
CNG-025-24	25	48	10 ^{+0.036} ₀	10	5.5	37	(48.4)
CNG-032-24	32	53	12 ^{+0.043} ₀	10	6.6	38.5	(56.4)
CNG-040-24	40	60	14 ^{+0.043} ₀	10	6.6	42.5	(58.4)

Part no.	Applicable bore size (mm)	TR	TT	TU	TV	TW	TX	TY	TZ
CNG-020-24	20	13	3.2	21.2	47.8	42	26	28	50
CNG-025-24	25	15	3.2	21.3	54.8	42	28	28	57
CNG-032-24	32	17	4.5	25.6	57.4	48	28	28	61.4
CNG-040-24	40	21	4.5	26.3	65.4	56	36	30	71.4

Knuckle Pin

Material: Carbon steel

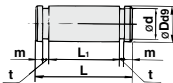

(mm)

Part no.	Applicable bore size (mm)	D99	L	d	L1	m	t	Applicable retaining ring
IY-G02	20	8 ^{-0.042} _{-0.076}	21	7.6	16.2	1.5	0.9	Type C-8 for axis
IY-G03	25, 32	10 ^{-0.052} _{-0.076}	25.6	9.6	20.2	1.55	1.15	Type C-10 for axis
IY-G04	40	10 ^{-0.062} _{-0.076}	41.6	9.6	36.2	1.55	1.15	Type C-10 for axis

* Retaining rings are included.

Clevis Pin

Material: Carbon steel

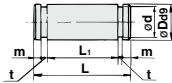

(mm)

Part no.	Applicable bore size (mm)	D99	L	d	L1	m	t	Applicable retaining ring
CD-G02	20	8 ^{-0.040} _{-0.076}	43.4	7.6	38.6	1.5	0.9	Type C-8 for axis
CD-G25	25	10 ^{-0.040} _{-0.076}	48	9.6	42.6	1.55	1.15	Type C-10 for axis
CD-G03	32	12 ^{-0.050} _{-0.090}	59.4	11.5	54	1.55	1.15	Type C-12 for axis
CD-G04	40	14 ^{-0.060} _{-0.090}	71.4	13.4	65	2.05	1.15	Type C-14 for axis

* Retaining rings are included.

Double Knuckle Joint

* Knuckle pin and retaining ring are attached.

Y-G02/G03

Material: Rolled steel

Y-G04

Material: Cast iron

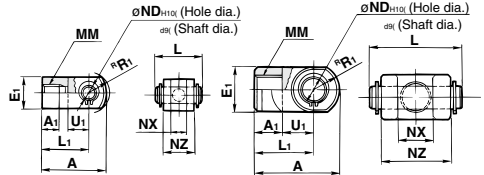

(mm)

Part no.	Applicable bore size (mm)	A	A1	E1	L1	MM	R1	U1	ND	NX	NZ	L	Applicable pin part no.
Y-G02	20	34	8.5	16	25	M8 x 1.25	10.3	11.5	8	8 ^{+0.2} ₀	16	21	IY-G02
Y-G03	25, 32	41	10.5	20	30	M10 x 1.25	12.8	14	10	10 ^{+0.2} ₀	20	25.6	IY-G03
Y-G04	40	42	16	22	30	M14 x 1.5	12	14	10	18 ^{+0.2} ₀	36	41.6	IY-G04

Head Side Pivot Bracket

ø20 to ø40

Material: Rolled steel

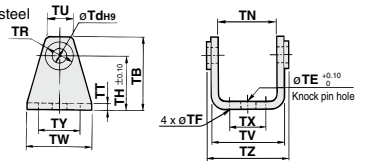

(mm)

Part no.	Applicable bore size (mm)	TB	TdH9	TE	TF	TH	TN
CG-020-24A	20	36	8 ^{+0.036} ₀	10	5.5	25	(29.3)
CG-025-24A	25	43	10 ^{+0.036} ₀	10	5.5	30	(33.1)
CG-032-24A	32	50	12 ^{+0.043} ₀	10	6.6	35	(40.4)
CG-040-24A	40	58	14 ^{+0.043} ₀	10	6.6	40	(49.2)

Part no.	Applicable bore size (mm)	TR	TT	TU	TV	TW	TX	TY	TZ
CG-020-24A	20	13	3.2	18.1	35.8	42	16	28	38.3
CG-025-24A	25	15	3.2	20.7	39.8	42	20	28	42.1
CG-032-24A	32	17	4.5	23.6	49.4	48	22	28	53.8
CG-040-24A	40	21	4.5	27.3	58.4	56	30	30	64.6

Rod End Nut

Material: Rolled steel

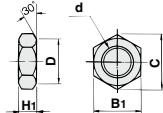

(mm)

Part no.	Applicable bore size (mm)	B1	C	D	d	H1
NT-02	20	13	(15)	12.5	M8 x 1.25	5
NT-03	25, 32	17	(19.6)	16.5	M10 x 1.25	6
NT-G04	40	19	(21.9)	18	M14 x 1.5	8

Auto Switch Mounting 1

Auto Switch Proper Mounting Position (Detection at Stroke End) and Its Mounting Height

Reed auto switch

D-A9□

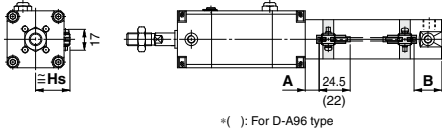

*() : For D-A96 type

D-C7, C8

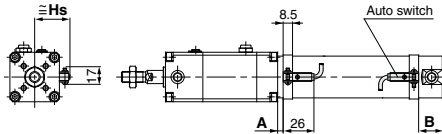

D-C73C, C80C

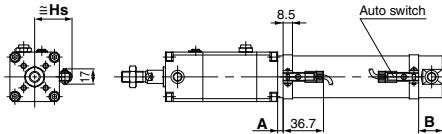

D-B5, B6, B59W

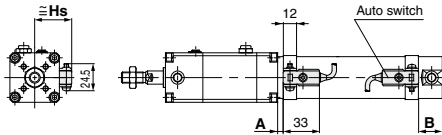

Solid state auto switch

D-M9□, D-M9□A

D-M9□W

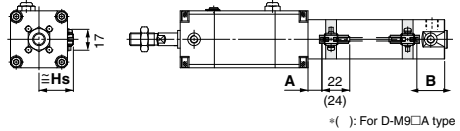

*() : For D-M9□A type

D-G5NT

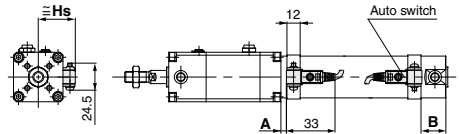

D-H7□, H7□W

D-H7NF, H7BA

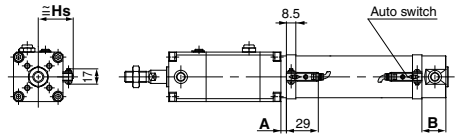

D-H7C

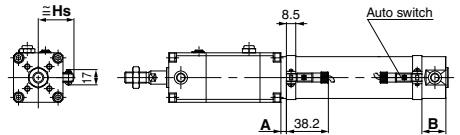

Auto Switch Proper Mounting Position

Auto switch mode	Auto Switch Proper Mounting Position (mm)													
	D-M9□(V) D-M9□W(V) D-M9□A(V)		D-A9□(V)		D-C7/C8 D-C73C D-C80C		D-B5 D-B6		D-B59W		D-H7□ D-H7C D-H7□W D-H7BA D-H7NF		D-G5□W D-K59W D-G59F D-G5 D-K5 D-G5NT D-G5BA	
	A	B	A	B	A	B	A	B	A	B	A	B	A	B
Bore size (mm)	12	24 (32)	8	20 (28)	8.5	20.5 (28.5)	2.5	14.5 (22.5)	5.5	17.5 (25.5)	7.5	19.5 (27.5)	4	16 (24)
20	12	24 (32)	8	20 (28)	8.5	20.5 (28.5)	2.5	14.5 (22.5)	5.5	17.5 (25.5)	7.5	19.5 (27.5)	4	16 (24)
25	12	24 (32)	8	20 (28)	8.5	20.5 (28.5)	2.5	14.5 (22.5)	5.5	17.5 (25.5)	7.5	19.5 (27.5)	4	16 (24)
32	13	25 (33)	9	21 (29)	9.5	21.5 (29.5)	3.5	15.5 (23.5)	6.5	18.5 (26.5)	8.5	20.5 (28.5)	5	17 (25)
40	18	27 (36)	14	23 (32)	14.5	23.5 (32.5)	8.5	17.5 (26.5)	11	20.5 (29.5)	13.5	22.5 (31.5)	10	19 (28)

*() : For the long stroke type

Note) Adjust the auto switch after confirming the operating conditions in the actual setting.

Auto Switch Mounting Height

Auto switch mode	Auto Switch Mounting Height (mm)				
	D-M9□(V) D-M9□W(V) D-M9□A(V) D-A9□(V)		D-H7□ D-H7W D-H7NF D-H7BA D-C7/C8	D-C73C D-C80C	D-B5/B6 D-B59W D-G59F D-G5/K5 D-G5W D-G5BA D-K59W
	Hs		Hs	Hs	
Bore size (mm)	26.5		27	27.5	
20	26.5		27	27.5	
25	29		29.5	30	
32	32.5		33	33.5	
40	37		37.5	38	

Minimum Auto Switch Mounting Stroke

n: No. of auto switches (mm)

Auto switch model	No. of auto switches mounted				
	1	2		n	
		Different surfaces	Same surface	Different surfaces	Same surface
D-M9□	5	15 Note 1)	40 Note 1)	$20 + 35 \frac{(n-2)}{2}$ (n = 2, 4, 6...) ^{Note 3)}	$55 + 35 (n-2)$ (n = 2, 3, 4, 5...)
D-M9□W	10	15 Note 1)	40 Note 1)	$20 + 35 \frac{(n-2)}{2}$ (n = 2, 4, 6...) ^{Note 3)}	$55 + 35 (n-2)$ (n = 2, 3, 4, 5...)
D-M9□A	10	25	40 Note 1)	$25 + 35 \frac{(n-2)}{2}$ (n = 2, 4, 6...) ^{Note 3)}	$60 + 35 (n-2)$ (n = 2, 3, 4, 5...)
D-A9□	5	15	30 Note 1)	$15 + 35 \frac{(n-2)}{2}$ (n = 2, 4, 6...) ^{Note 3)}	$50 + 35 (n-2)$ (n = 2, 3, 4, 5...)
D-M9□V	5	20	35	$20 + 35 \frac{(n-2)}{2}$ (n = 2, 4, 6...) ^{Note 3)}	$35 + 35 (n-2)$ (n = 2, 3, 4, 5...)
D-A9□V	5	15	25	$15 + 35 \frac{(n-2)}{2}$ (n = 2, 4, 6...) ^{Note 3)}	$25 + 35 (n-2)$ (n = 2, 3, 4, 5...)
D-M9□WV D-M9□AV	10	20	35	$20 + 35 \frac{(n-2)}{2}$ (n = 2, 4, 6...) ^{Note 3)}	$35 + 35 (n-2)$ (n = 2, 3, 4, 5...)
D-C7□ D-C80	5	20	60	$20 + 45 \frac{(n-2)}{2}$ (n = 2, 4, 6...) ^{Note 3)}	$60 + 45 (n-2)$ (n = 2, 3, 4, 5...)
D-H7□ D-H7□W D-H7BA D-H7NF	10	25	70	$25 + 45 \frac{(n-2)}{2}$ (n = 2, 4, 6...) ^{Note 3)}	$70 + 45 (n-2)$ (n = 2, 3, 4, 5...)
D-C73C D-C80C D-H7C	5	30	80	$30 + 50 \frac{(n-2)}{2}$ (n = 2, 4, 6...) ^{Note 3)}	$80 + 50 (n-2)$ (n = 2, 3, 4, 5...)
D-B5□ D-B64 D-G5□ D-K59□	5	25	70	$25 + 50 \frac{(n-2)}{2}$ (n = 2, 4, 6...) ^{Note 3)}	$70 + 50 (n-2)$ (n = 2, 3, 4, 5...)
D-B59W	10	30	75	$30 + 50 \frac{(n-2)}{2}$ (n = 2, 4, 6...) ^{Note 3)}	$75 + 50 (n-2)$ (n = 2, 3, 4, 5...)

Note 3) When "n" is an odd number, an even number that is one larger than this odd number is used for the calculation.

Note 1) Auto switch mounting

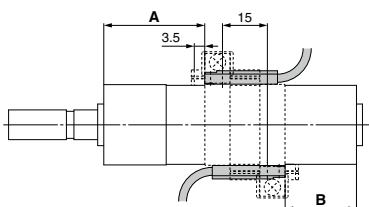
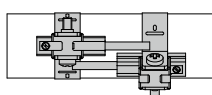
Auto switch model	With 2 auto switches	
	Different surfaces	Same surface
	 <p>Correct auto switch mounting position is 3.5 mm from the back face of the switch holder.</p>	 <p>The auto switch is mounted by slightly displacing it in a direction (cylinder tube circumferential exterior) so that the auto switch and lead wire do not interfere with each other.</p>
D-M9□ D-M9□W	Less than 20 stroke ^{Note 2)}	Less than 55 stroke ^{Note 2)}
D-M9□A	Less than 20 stroke ^{Note 2)}	Less than 60 stroke ^{Note 2)}
D-A9□	—	Less than 50 stroke ^{Note 2)}

Note 2) Minimum stroke for mounting auto switches in the other mounting types mentioned in note 1.

Operating Range

Auto switch model	Bore size (mm)			
	20	25	32	40
D-A9□	7	6	8	8
D-M9□ D-M9□W	4.5	5	4.5	5.5
D-C7□/C-80 D-C73C/C-80C	8	10	9	10
D-B5□/B64	8	10	9	10
D-B59W	13	13	14	14
D-H7□/H7□W D-H7BA/H7NF	4	4	4.5	5
D-H7C	7	8.5	9	10
D-G5NT	4	4	4.5	5

* Since the operating range is provided as a guideline including hysteresis, it cannot be guaranteed (assuming approximately ±30% dispersion). It may vary substantially depending on an ambient environment.

Auto Switch Mounting Bracket: Part No.

Auto switch model	Bore size(mm)			
	20	25	32	40
D-M9□(V) D-M9□W(V) D-A9□(V)	Note 1) BMA3-020 (A set of a, b, c, d)	Note 1) BMA3-025 (A set of a, b, c, d)	Note 1) BMA3-032 (A set of a, b, c, d)	Note 1) BMA3-040 (A set of a, b, c, d)
D-M9□A(V) (Note 2)	BMA3-020S (A set of b, c, e, f)	BMA3-025S (A set of b, c, e, f)	BMA3-032S (A set of b, c, e, f)	BMA3-040S (A set of b, c, e, f)
D-H7□ D-H7□W D-H7NF D-C7□/C80 D-C73C/C80C	BMA2-020A (A set of c and d)	BMA2-025A (A set of c and d)	BMA2-032A (A set of c and d)	BMA2-040A (A set of c and d)
D-H7BA	BMA2-020AS (A set of c and f)	BMA2-025AS (A set of c and f)	BMA2-032AS (A set of c and f)	BMA2-040AS (A set of c and f)
D-B5□/B64 D-B59W D-G5□/K59 D-G5□W/K59W D-G5BA/G59F D-G5NT	BA-01 (A set of c and d)	BA-02 (A set of c and d)	BA-32 (A set of c and d)	BA-04 (A set of c and d)

Note 1) Since the switch bracket (made from nylon) are affected in an environment where alcohol, chloroform, methylamines, hydrochloric acid or sulfuric acid is splashed over, so it cannot be used. Please consult SMC regarding other chemicals.

Note 2) When mounting a D-M9□A(V) type auto switch, if the switch bracket is mounted on the indicator light, it may damage the auto switch. Therefore, be sure to avoid mounting the switch bracket on the indicator light.

[Mounting screw set made of stainless steel]

The following set of mounting screws made of stainless steel is available. Use it in accordance with the operating environment.

(Please order the auto switch mounting bracket separately, since it is not included.)

BBA3: D-B5,B6,G5,K5 types

BBA4: D-C7,C80,H7 types

Note) Refer to page 1439 for details on the BBA3.





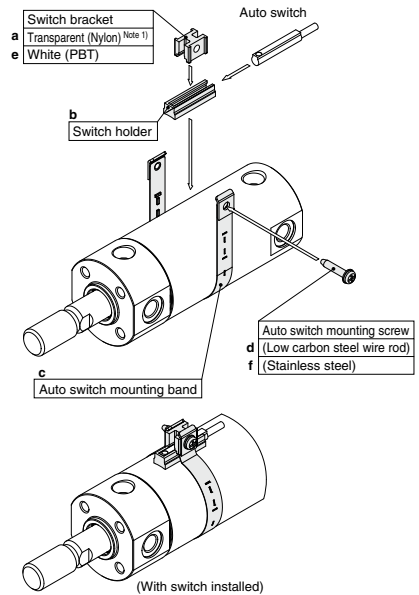

The above stainless steel screws are used when a cylinder is shipped with the D-H7BA/G5BA auto switch.

When only an auto switch is shipped independently, the BBA3 or BBA4 is attached.



* Band (c) is mounted so that the projected part is on the internal side (contact side with the tube).

Cylinder Brackets by Stroke/Mounting Surfaces

Mounting bracket	Basic type, Foot type, Flange type, Clevis type			Trunnion type		
	1 (Rod cover side)	2 (Different surfaces)	2 (Same surface)	1 (Rod cover side)	2 (Different surfaces)	2 (Same surface)
No. of auto switches mounted						
Switch mounting surface	Port surface 	Port surface 	Port surface 			
Switch model						
D-A9□ D-M9□ D-M9□W	10 st or more	15 to 44 st	45 st or more	10 st or more	15 to 44 st	45 st or more
D-C7□/C80	10 st or more	15 to 49 st	50 st or more	10 st or more	15 to 49 st	50 st or more
D-H7□/H7□W D-H7BA/H7NF	10 st or more	15 to 59 st	60 st or more	10 st or more	15 to 59 st	60 st or more
D-C73C/C80C/H7C	10 st or more	15 to 64 st	65 st or more	10 st or more	15 to 64 st	65 st or more
D-B5□/B64/G5NT	10 st or more	15 to 74 st	75 st or more	10 st or more	15 to 74 st	75 st or more
D-B59W	15 st or more	20 to 74 st	75 st or more	15 st or more	20 to 74 st	75 st or more

st: stroke(mm)

Other than the applicable auto switches listed in “How to Order”, the following auto switches can be mounted.
For detailed specifications, refer to pages 1341 to 1435.

Auto switch type	Model	Electrical entry (Fetching direction)	Features
Reed	D-B53, C73, C76	Grommet (In-line)	—
	D-C80		Without indicator light
Solid state	D-H7A1, H7A2, H7B		—
	D-H7NW, H7PW, H7BW		Diagnostic indication (2-color)
	D-G5NT		With timer

* For solid state auto switches, auto switches with a pre-wired connector are also available. Refer to pages 1410 and 1411 for details.
* Normally closed (NC = b contact) solid state auto switches (D-M9□E(V)) are also available. Refer to page 1360 for details.



CNG Series

Specific Product Precautions 1

Be sure to read this before handling the products.

Refer to page 9 for safety instructions and pages 10 to 19 for actuator and auto switch precautions.

Design of Equipment and Machinery

Warning

1. Construct so that the human body will not come into direct contact with driven objects or the moving parts of locking cylinders.

Devise a safe structure by attaching protective covers that prevent direct contact with the human body, or in cases where there is a danger of contact, provide sensors or other devices to perform an emergency stop, etc., before contact occurs.

2. Use a balance circuit, taking cylinder lurching into consideration.

In cases such as an intermediate stop, where a lock is operated at a desired position within the stroke and air pressure is applied from only one side of the cylinder, the piston will lurch at high speed when the lock is released. In such situations, there is a danger of causing human injury by having hands or feet, etc. caught, and also a danger for causing damage to the equipment. In order to prevent this lurching, a balance circuit such as the recommended pneumatic circuits (pages 710 and 711) should be used.

Selection

Warning

1. When in the locked state, do not apply a load accompanied by an impact shock, strong vibration or turning force, etc.

Use caution, because an external action such as an impacting load, strong vibration or turning force, may damage the locking mechanism or reduce its life.

2. Consider stopping accuracy and the amount of overrun when an intermediate stop is performed.

Due to the nature of a mechanical lock, there is a momentary lag with respect to the stop signal, and a time delay occurs before stopping. The cylinder stroke resulting from this delay is the overrun amount. The difference between the maximum and minimum overrun amounts is the stopping accuracy.

- Place a limit switch before the desired stopping position, at a distance equal to the overrun amount.
 - The limit switch must have a detection length (dog length) of the overrun amount + ϕ .
 - For SMC's auto switches, the operating range is between 8 and 14 mm. (It varies depending on a switch model.) When the overrun amount exceeds this range, selfholding of the contact should be performed at the switch load side.
- * For stopping accuracy, refer to page 693.

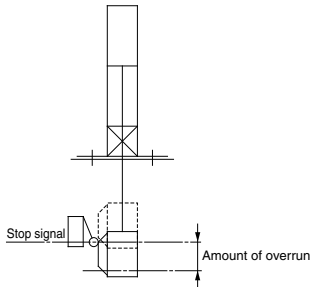

Selection

Warning

3. In order to further improve stopping accuracy, the time from the stop signal to the operation of the lock should be shortened as much as possible.

To accomplish this, use a device such as a highly responsive electric control circuit or solenoid valve driven by direct current, and place the solenoid valve as close as possible to the cylinder.

4. Note that the stopping accuracy will be influenced by changes in piston speed.

When piston speed changes during the course of the cylinder stroke due to variations in the load or disturbances, etc., the dispersion of stopping positions will increase. Therefore, consideration should be given to establishing a standard speed for the piston just before it reaches the stopping position. Moreover, the dispersion of stopping positions will increase during the cushioned portion of the stroke and during the accelerating portion of the stroke after the start of operation, due to the large changes in piston speed.

5. The holding force (max. static load) indicates the maximum capability to hold a static load without loads, vibration and impact. This does not indicate a load that can be held in ordinary conditions.

Select the most suitable bore sizes for the operating conditions in accordance with the selection procedures. The Model Selection (pages 690 and 691) is based on use at the intermediate stop (including emergency stops during operation). However, when the cylinder is in a locked state, kinetic energy does not act upon it. Under these conditions, use the load mass at the maximum speed (V) of 100 mm/s shown in graphs (5) to (7) on page 691 depending on the operating pressure and select models.

Mounting

Warning

1. Be certain to connect the rod end to the load with the lock released.

If connected in the locked state, a load greater than the turning force or holding force may operate on the piston rod and cause damage to the lock mechanism. The CNG series is equipped with an emergency unlocking mechanism, however, when connecting the rod end to the load this should be done with the lock released by simply connecting an air line to the unlocking port and supplying a pressure of 0.25 MPa or more.

2. When the cylinder is used as mounted with a single side fixed or free (basic type, flange type), a bending moment will be applied to the cylinder due to the vibration generated at the stroke end, and the cylinder may be damaged. In such a case, mount a bracket to reduce the vibration of the cylinder or use the cylinder at a piston speed low enough to prevent the cylinder from vibrating at the stroke end.

Also, please use a support bracket when the cylinder body moves or when the long stroke cylinder is fixed horizontally on one side.

Caution

1. Install a rod boot without twisting.

If the cylinder is installed with its bellows twisted, it could damage the bellows.

2. Tighten clevis bracket mounting bolts with the following proper tightening torque.

$\phi 20$: 1.5 N·m, $\phi 25$ to 32 : 2.9 N·m, $\phi 40$: 4.9 N·m, $\phi 50$: 11.8 N·m, $\phi 63$ to 80 : 24.5 N·m, $\phi 100$: 42.2 N·m



CNG Series

Specific Product Precautions 2

Be sure to read this before handling the products.

Refer to page 9 for safety instructions and pages 10 to 19 for actuator and auto switch precautions.

Mounting

⚠ Caution

1. Do not apply offset loads to the piston rod.

Particular care should be taken to match the load's center of gravity with the center of the cylinder shaft. When there is a large discrepancy, the piston rod may be subjected to uneven wear or damage due to the inertial moment during locking stops.

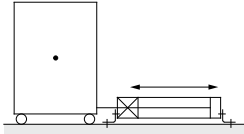

X Load center of gravity and cylinder shaft center are not matched.

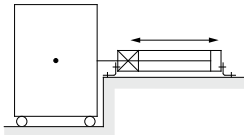

O Load center of gravity and cylinder shaft center are matched.

Note) Can be used if all of the generated moment is absorbed by an effective guide.

Adjustment

⚠ Warning

1. Do not operate the cushion valve in the fully closed or fully opened state.

Using it in the fully closed state will cause the cushion seal to be damaged. Using it in the fully opened state will cause the piston rod assembly or the cover to be damaged.

2. Operate within the specified cylinder speed.

Otherwise, cylinder and seal damage may occur.

3. Carefully check the cushion performance in a low speed range.

The performance and effect at around 50 mm/s may vary depending on the individual difference of each product.

⚠ Caution

1. Adjust the cylinder's air balance. Balance the load by adjusting the air pressure in the rod and head sides of the cylinder with the load connected to the cylinder and the lock released. Lurching of the cylinder when unlocked can be prevented by carefully adjusting this air balance.

2. Adjust mounting position for detection area of auto switch etc. When intermediate stop is done, adjust the mounting position for detection stop is done, adjust the mounting position for detection area of auto switch etc., with consideration of over-run distance to required stop position.

Pneumatic Circuit

⚠ Warning

1. Be certain to use a pneumatic circuit which will apply balancing pressure to both sides of the piston when in a locked stop.

In order to prevent cylinder lurching after a lock stop, when restarting or when manually unlocking, a circuit should be used to which will apply balancing pressure to both sides of the piston, thereby canceling the force generated by the load in the direction of piston movement.

2. The effective area of the unlocking solenoid valve should be at least 50% of the effective area of the cylinder driving solenoid valve, and it should be installed as close to the cylinder as possible so that it is closer than the cylinder driving solenoid valve.

If the effective area of the unlocking solenoid valve is small or if it is installed at a distance from the cylinder, the time required for exhausting air for unlocking will be longer, which may cause a delay in the locking operation. The delay in the locking operation may result in problems such as increase of overrun when performing intermediate stop or emergency stop during operation, or if maintaining position from the operation stop state such as drop prevention, workpieces may be dropped depending on the timing of the lock action to the operation delay of the lock.

3. Avoid backflow of the exhaust pressure when there is a possibility of interference of exhaust air, for example for a common exhaust type valve manifold.

The lock may not operate properly when the exhaust air pressure backflows due to interference of the exhaust air when exhausting air for lock release. It is recommended to use an individual exhaust type manifold or individual valves.

4. Allow at least 0.5 seconds from a locked stop (intermediate stop of the cylinder) until release of the lock.

When the locked stop time is too short, the piston rod (and load) may lurch at a speed greater than the control speed of the speed controller.

5. When restarting, control the switching signal for the unlocking solenoid valve so that it acts before or at the same time as the cylinder drive solenoid valve.

If the signal is delayed, the piston rod (and load) may lurch at a speed greater than the control speed of the speed controller.

6. Carefully check for dew condensation due to repeated air supply and exhaust of the locking solenoid valve.

The operating stroke of the lock part is very small. So, if the piping is long and the air supply and exhaust are repeated, the dew condensation caused by the adiabatic expansion accumulates in the lock part. This may corrode internal parts, causing air leak or lock release fault.

7. Basic circuit

1. [Horizontal]

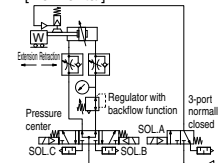

SOL A	SOL B	SOL C	Action
ON	ON	OFF	Extension
OFF	OFF	OFF	Locked stop
ON	OFF	OFF	Unlocked
ON	ON	OFF	Extension
ON	OFF	ON	Retraction
OFF	OFF	OFF	Locked stop
ON	OFF	OFF	Unlocked
ON	OFF	ON	Retraction

0.5 s or more
0 to 0.5 s
0.5 s or more
0 to 0.5 s

2. [Vertical]

[Load in the direction of rod extension]

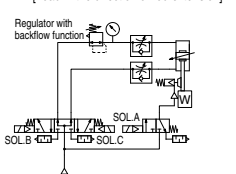

[Load in the direction of rod retraction]

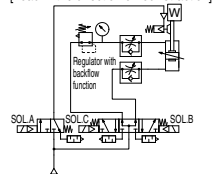

* The symbol for the cylinder with lock in the basic circuit uses SMC original symbol.



CNG Series

Specific Product Precautions 3

Be sure to read this before handling the products.

Refer to page 9 for safety instructions and pages 10 to 19 for actuator and auto switch precautions.

Pneumatic Circuit

⚠ Caution

- 3-position pressure center solenoid valve and regulator with backflow function can be replaced with two 3-port normally open valves and a regulator with relief function.

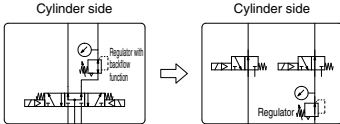

[Example]

- [Horizontal]

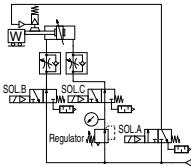

- [Vertical]

[Load in the direction of rod extension]

[Load in the direction of rod retraction]

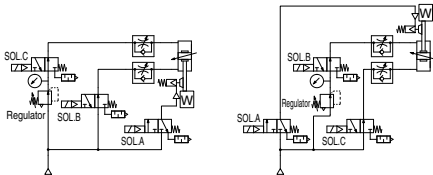

* The symbol for the cylinder with lock in the pneumatic circuit uses SMC original symbol.

Manually Unlocking

⚠ Warning

- Never operate the unlocking cam until safety has been confirmed. (Do not turn to the FREE side.)
 - When unlocking is performed with air pressure applied to only one side of the cylinder, the moving parts of the cylinder will lurch at high speed causing a serious hazard.
 - When unlocking is performed, be sure to confirm that personnel are not within the load movement range and that no other problems will occur if the load moves.
- Before operating the unlocking cam, exhaust any residual pressure which is in the system.
- Take measures to prevent the load from dropping when unlocking is performed.
 - Perform work with the load in its lowest position.
 - Take measures for drop prevention by strut, etc.

⚠ Caution

- The unlocking cam is an emergency unlocking mechanism only. During an emergency when the air supply is stopped or cut off, this is used to alleviate a problem by forcibly pushing back the release piston and brake spring to release the lock.
- When installing the cylinder into equipment or performing adjustments, etc., be sure to apply air pressure of 0.25 MPa or more to the unlocking port, and do not perform work using the unlocking cam.
- When releasing the lock with the unlocking cam, it must be noted that the internal resistance of the cylinder will be high, unlike normally unlocking with air pressure.

Bore size (mm)	Cylinder internal resistance (N)	Cam operating torque (standard) (N·m)	Max. cam operating torque (N·m)	Applicable hex. wrench size
20	24.6	1.0	2.3	Size 3
25	38.2	2.5	4.7	Size 3
32	62.7	3.0	4.7	Size 3
40	98	4.0	8.2	Size 4

- Be sure to operate the unlocking cam on the FREE side (clockwise direction), and do not turn with a torque greater than the maximum cam operating torque. There is a danger of damaging the unlocking cam if it is turned excessively.
- For safety reasons, the unlocking cam is constructed so that it cannot be fixed in the unlocked condition.

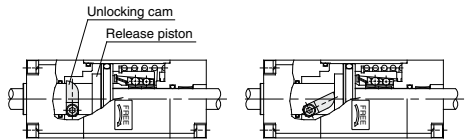

[Principle]

If the unlocking cam is turned in a clockwise direction with a hexagon wrench, the release piston is pushed back and the lock is released. Further, if the unlocking cam is not held it will return to its original position and the unit will lock again. Therefore, the unlocking cam must be held in position for as long as unlocking is required.



CNG Series Specific Product Precautions 4

Be sure to read this before handling the products.
Refer to page 9 for safety instructions and pages 10 to 19 for actuator and auto switch precautions.

Maintenance

⚠ Caution

1. The CNG series lock units are replaceable.
(However, please note that lock units cannot be replaced in the case of long stroke specifications.)
To order replacement lock units for the CNG series, use the order numbers given in the table below.

Bore size (mm)	Lock unit part no.	
	Rubber bumper type	Air cushion type
20	CNGN20D-UA	CNGA20D-UA
25	CNGN25D-UA	CNGA25D-UA
32	CNGN32D-UA	CNGA32D-UA
40	CNGN40D-UA	CNGA40D-UA

2. Replacement of lock units.

- Remove the lock unit by securing the square section of the rod cover or the wrench flats of the tube cover in an apparatus such as a vice, and then loosening the other end with a spanner or adjustable angle wrench, etc.
For the dimensions of the square section and the wrench flats, refer to the table below.

Bore size (mm)	Rod cover square section (mm)	Tube cover wrench flats (mm)
20	38	24
25	45	29
32	45	35.5
40	52	44

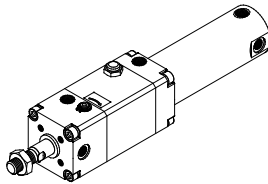

- Remove the tube cover.

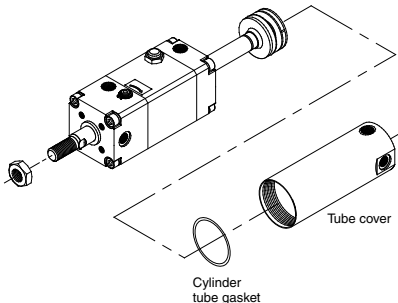

- Apply 0.3 MPa or more of compressed air to the unlocking port, and pull out the piston rod assembly.

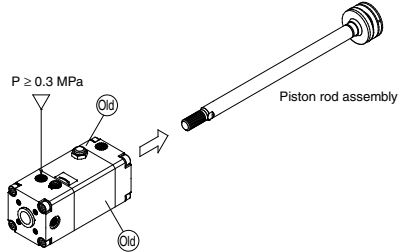

- Similarly, apply 0.3 MPa or more of compressed air to the unlocking port of the new lock unit, and replace the new lock unit's temporary axis with the previous piston rod assembly.

Note) Be sure to keep applying compressed air with a pressure of at least 0.3 MPa to the lock releasing port when replacing the temporary axis of a new lock unit and a piston rod assembly.
If the compressed air applied to the unlocking port is released (when it is in the lock condition) while the temporary axis and the piston rod assembly are removed from the lock unit, the brake shoe will be deformed and it will become impossible to insert the piston rod assembly, which will make the lock unit impossible to use.

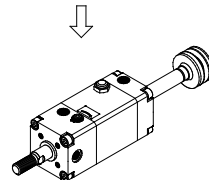
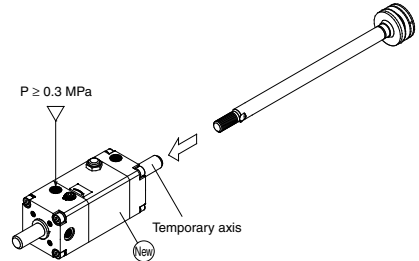

- Reassemble in reverse order from steps 2) and 1).
When retightening the sections, turn approximately 2° past their position prior to disassembly.