

Floating Joint/Lightweight and Compact Type

JT Series



Compact

Model	Connection thread	Shortened dimensions	Overall length
JT20	M8 x 1.25	12.3 mm	27.2 mm
JT32	M10 x 1.25	13.0 mm	33.0 mm
JT40	M14 x 1.5	19 mm	43.0 mm

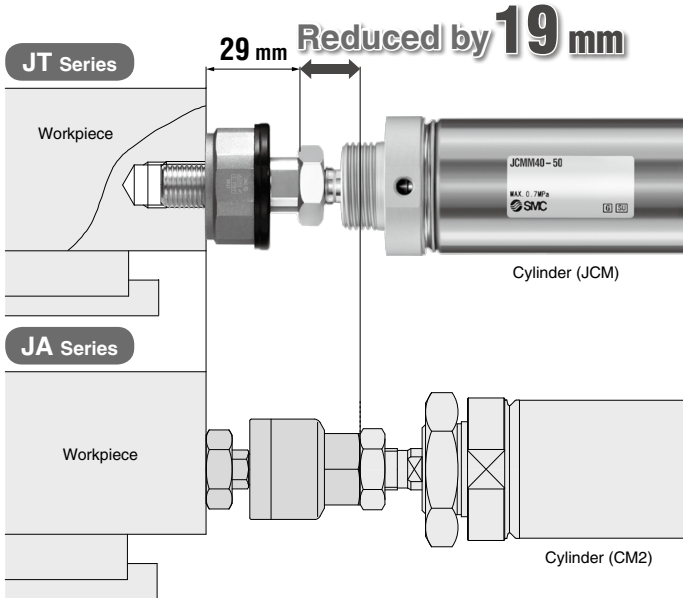
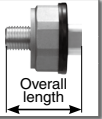

Max. **Weight 56% lighter**
 50 g → 22 g (Compared to JA20)

Size	JA Series	JT Series
20	50 g	22 g
32	70 g	38 g
40	160 g	98 g

- Screw size is the same as the screw size for standard JA series.
- Applicable for space saving cylinder (JCM series)
- With dustproof cover

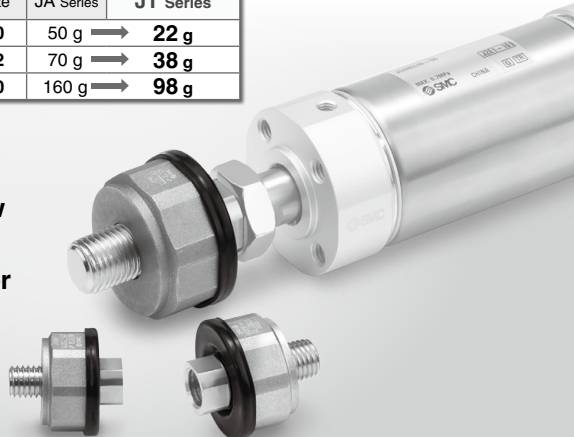

Floating Joint JT Series

More compact and light-weight combination are available by using the JT series with a JCM series cylinder.

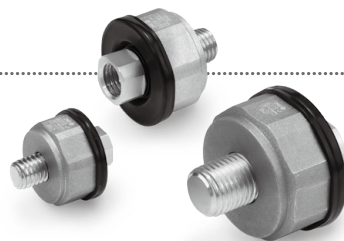

Reduction of length when using JT and JCM

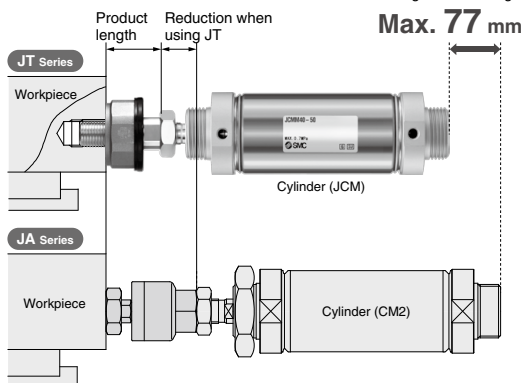







Overall Length Comparison

Size	JA + CM2 Series	JT + JCM Series	Reduction rate
20	139.5 mm	90.2 mm	35%
32	149.0 mm	96.0 mm	36%
40	189.0 mm	112.0 mm	41%

Weight Comparison

Size	JA + CM2 Series	JT + JCM Series	Reduction rate
20	190 g	102 g	46%
32	350 g	188 g	46%
40	720 g	378 g	48%

Series Variations

Series	Supply pressure for cylinder		Applicable cylinder bore size [mm]	Mounting	Page
JT Series (Lightweight and compact type) 	Pneumatic cylinder	0.7 MPa or less	20, 25, 32, 40	Basic	p. 1223
JC Series (Light weight type for light load) 	Pneumatic cylinder	1 MPa or less	20, 25, 32, 40, 50, 63	Basic	p. 1227
JA Series (Standard) 	Pneumatic cylinder	0.7 MPa or less	6, 10, 15	Basic, Foot, Flange	p. 1233
	Hydraulic cylinder	1 MPa or less	20, 25, 32, 40, 50, 63, 80, 100, 125, 140, 160, (180, 200)		
JAH Series (Heavy load) 	Hydraulic cylinder	7 MPa or less	40, 50, 63, 80, 100	Basic, Foot, Flange	p. 1241
JB Series (For compact cylinders) 	Pneumatic cylinder	1 MPa or less	12, 16, 20, 25, 32, 40, 50, 63, 80, 100	Basic (Female thread)	p. 1244
JS Series (Stainless steel type) 	Pneumatic cylinder	1 MPa or less	10, 16, 20, 25, 32, 40, 50, 63, (80, 100)	Basic	p. 1246
	Hydraulic cylinder	3.5 MPa or less	20, 25, 32, 40, 50, 63		

() Available as special product

Standard/Lightweight and Compact Type Floating Joint

JT Series

RoHS



Specifications

Model	Nominal thread size	Allowable axial force [N]	Allowable eccentricity U [mm]	Rotating angle [°]	Operating temperature range
JT20	M8 x 1.25	220	0.5	±2	-10 to 70°C
JT32	M10 x 1.25	560	0.5	±2	
JT40	M14 x 1.5	880	0.75	±2	

Operating range

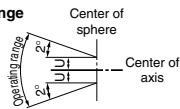

Applicable Cylinder

Model	Applicable cylinder *1		Recommended cylinder
	Bore size	Operating pressure	
JT20	ø20	0.7 MPa or less	JC□M20 (Rod end male thread type)
	ø25		JC□M25 (Rod end male thread type)
JT32	ø32		JC□M32 (Rod end male thread type)
	ø40		JC□M40 (Rod end male thread type)

*1: Make sure to use a cylinder with a built-in cushion mechanism.

How to Order

JT 20

Size	Applicable cylinder	Nominal thread size
20	For ø20	M8 x 1.25
32	For ø25	M10 x 1.25
	For ø32	M10 x 1.25
40	For ø40	M14 x 1.5

Operating Conditions

Operating pressure	Pneumatic cylinder: 0.7 MPa or less
Mounting	Basic
Operating temperature	-10 to 70°C

JT Series

Construction

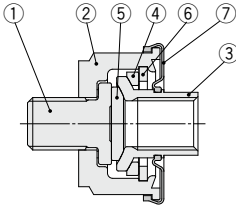

No.	Description	Material	Note
1	Stud	Carbon steel	Zinc chromated
2	Bowl	Aluminum alloy	Chromated
3	Socket	Carbon steel	Zinc chromated
4	Ring	Rolled steel	Nitriding treatment
5	Slider	Rolled steel	Nitriding treatment
6	Plate	Rolled steel	Zinc chromated
7	Dust cover	Synthetic rubber	

Replacement Part

No.	Description	Part no.	Applicable model
7	Dust cover	P215420-07	For JT20
		P215432-07	For JT32
		P215440-07	For JT40

Dimensions

JT20 to 40

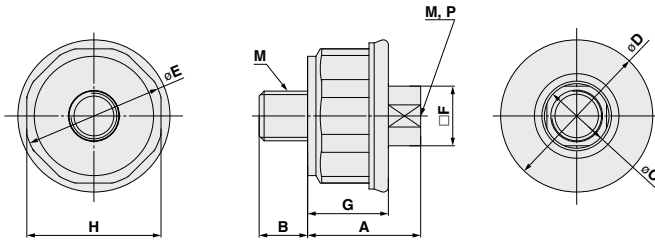
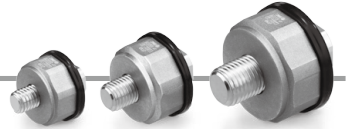

Standard Pneumatic: Up to 0.7 MPa

[mm]

Model	Connection thread M	A	B	øC	øD	øE	□F	G	Width across flats H	Maximum thread depth P	Weight
JT20	M8 x 1.25	19.2	8	11	(25.4)	23	10	13.6	22	9.5	22 g
JT32	M10 x 1.25	23	10	13.4	(30.6)	28	12	16.3	27	11.5	38 g
JT40	M14 x 1.5	29	14	19	(40.4)	37.4	17	20.3	36	15.5	98 g

※: Value in () is the dimension when the dust cover is used.



JT Series

Specific Product Precautions 1

Be sure to read this before handling the products. Refer to page 20 for safety instructions and pages 21 to 25 for actuator precautions.

Design

Warning

1. Check the application.

This product is a shaft coupling for linear reciprocating motion used to absorb slight misalignment of the workpiece and the cylinder during linear motion. It is not a shaft coupling for rotation. Do not use it for an application in which rotation or oscillation is applied.

2. Use a foot type or flange type bracket to mount a cylinder.

If a clevis type or trunnion type bracket is used, the cylinder shaft will not be fixed and it will be able to rotate. This mounting method, which exceeds the allowable eccentricity and rotating angle of the floating joint, may cause breakage or malfunction of the product.

3. Use within the range of specifications.

Operation of the product under loading or with eccentricity outside of allowable specification may cause breakage or malfunction.

4. Use a cylinder with a built-in cushion mechanism.

When a driven object is stopped, ensure the impact force of the object being transferred to the floating joint is prevented by using a cylinder with a built-in cushion mechanism (rubber cushion or air cushion).

To stop the cylinder at the intermediate position, use an external shock absorbing mechanism such as a shock absorber. If the cushion mechanism or the external shock absorbing mechanism is not used, an excessive impact force will be generated when stopping the cylinder and this may cause breakage or malfunction of the product.

5. Install an external stopper to avoid run-away of the equipment.

If there is a risk of equipment damage or injury in the case of equipment running out of control or dropping off the driven object due to loose connecting screws, install an external stopper to avoid run-away of the equipment.

6. Play in the axial direction

The JT series has play in the axial direction. (Default: 0.15 mm or less) When positioning the driven object, avoid the influence of play using a knock pin or external stopper.

Mounting

Warning

1. Maintenance space

Allow sufficient space for maintenance and inspection.

2. Operate the socket by hand before mounting to ensure it moves smoothly.

The dust cover may stick to the socket. Move the dust cover at the base of the socket with fingers, or twist the socket right and left gently to free it before mounting.

Mounting

Warning

3. Tighten the product to the appropriate torque for the screw size using an appropriate tool. In addition, apply a locking adhesive.

When connecting the driven object to the cylinder rod with a floating joint, hold the octagonal and square parts with an appropriate wrench and tighten the floating joint to the appropriate tightening torque. Refer to the table on the below for the appropriate tightening torque.

The floating joint may be broken or malfunction if parts other than the octagonal or square parts are gripped and rotated with pliers or a wrench, or if it is tightened to an excessive torque. As a countermeasure against loosening caused by vibration or other reasons, apply locking adhesive.

Wrench Size and Tightening Torque

Model	Stud (Male thread side)		Socket (Female thread side)	
	Wrench size (Bowl)	Tightening torque	Wrench size (Socket)	Tightening torque
JT20	Width: 22 mm	12 N·m	Width: 10 mm	8 to 12 N·m
JT32	Width: 27 mm	24 N·m	Width: 12 mm	15 to 24 N·m
JT40	Width: 36 mm	68 N·m	Width: 17 mm	40 to 68 N·m

Reference drawing for correct mounting

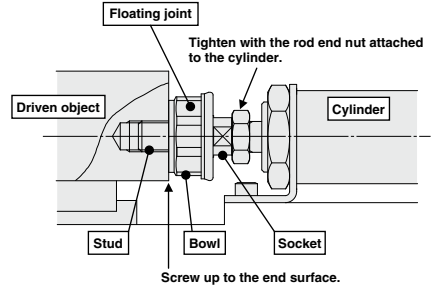

Operating Environment

Warning

1. Avoid using in a location where the product could be splashed by liquids such as coolants and water. Also, avoid locations where exposed to a large amount of dust or foreign matter.

If liquid or dust gets inside the floating joint from the gap of the dust cover, it may cause a malfunction. Install a protective cover if the product is directly splashed by liquids or foreign matter can be accumulated.

2. Do not expose the product to direct sunlight for an extended period of time.



JT Series

Specific Product Precautions 2

Be sure to read this before handling the products. Refer to page 20 for safety instructions and pages 21 to 25 for actuator precautions.

Operation

Warning

1. **Use the product so that the kinetic energy does not exceed the allowable value of the cylinder.**

The J□M series cylinder is recommended to be used with the JT series. When operating the equipment, adjust the stroke end velocity according to the load so that the kinetic energy is no more than that of the allowable value of the cylinder.

Speed when stopping (stroke end velocity) = Average speed x 1.4

Also, when using cylinders or equipment other than the J□M series, adjust the stroke end velocity according to the load so that the kinetic energy is no more than that of the allowable value of the J□M series.

Maintenance

Warning

1. **Implement regular inspections as necessary when starting-up etc. Confirm that there is no loosening of the connection between the driven object and the cylinder.**

When the equipment is operated at high frequency, screws and play in the axial direction can increase and occur easily over time. Make sure to inspect the equipment before starting work to confirm that the screws have not been loosened and the play has not significantly increased.

2. **If the play in the axial direction becomes larger or abnormal operation is found, replace the product.**

Play in the axial direction of the floating joint will increase over time, even if the product is used constantly. If the amount of play becomes excessive to the application or the operation is inflexible, replace the product itself.

3. **Confirm that there is no weakening of the rubber bumper within the cylinder or adjustment error of the air cushion.**

If the rubber bumper of the cylinder is weakened or the adjustment of the air cushion is incorrect, an excessive impact force will be generated when the cylinder reaches its end of stroke, this may cause breakage or malfunction of the product. Replace the cylinder if the rubber bumper is weakening or readjust the air cushion if an adjustment error is found.

Other

Caution

1. **Chromate treatment is performed for the bowl of JT series for rust prevention. There may be slight variation in the evenness and tone of color, but this does not affect the resistance against rust or product performance.**

If the product with even tone of color is required for the application, it is available as a special request. Please contact SMC.

Floating Joint

JC Series

Light Weight Type for Light Load 20, 30, 40, 63

Light weight

Aluminum case

RoHS

With the aluminum case

30% Weight reduction

*Compared to the current model JA40

48 g
lighter

112 g

JC40

160 g

JA40

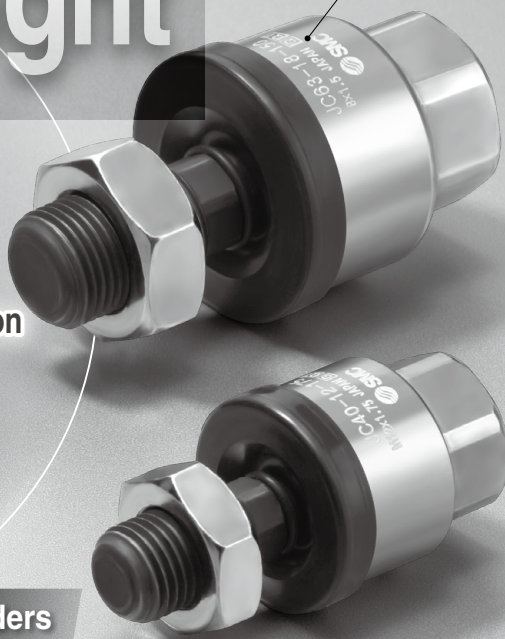

Product suitable for air cylinders

- Light weight mitigates lateral loads to air cylinders.
- Maximum tensile force equivalent to 1 MPa

Floating joint compensates for any misalignment between the work piece and the air cylinder.

Interchangeable mounting with the current JA series

Rotating angle $\pm 5^\circ$



Allowable eccentricity ± 0.5 to 1 mm

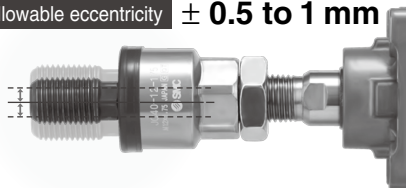

Floating Joint

Light Weight Type for Light Load

JC Series



Model/Specifications

Model	Applicable cylinder bore size (mm)	Applicable cylinder nominal thread size	Maximum operating tensile and compressive force (N)		Allowable eccentricity (Umm)	Rotating angle
			Basic type			
Standard/Thread nominal size						
JC20-8-125	20	M8 x 1.25	300		0.5	± 5°
JC30-10-125	25/32	M10 x 1.25	800		0.5	
JC40-14-150	40	M14 x 1.5	1250		0.75	
JC63-18-150	50/63	M18 x 1.5	3100		1	
Semi-standard/Thread nominal size						
JC20-8-100	20	M8 x 1	300		0.5	± 5°
JC25-10-150	25	M10 x 1.5	800		0.5	
JC32-10-100	32	M10 x 1	800		0.5	
JC40-12-125	32/40	M12 x 1.25	1250		0.75	
JC40-12-150	40	M12 x 1.5	1250		0.75	
JC40-12-175	32/40	M12 x 1.75	1250		0.75	
JC50-16-150	50	M16 x 1.5	3100		1	
JC63-16-200	50/63	M16 x 2	3100		1	

How to Order

JC 40 - 14-150

Applicable cylinder bore size

Standard type	Model	Symbol	Applicable cylinder bore size (mm)
			20
		30	25/32
		40	40
		63	50/63

Thread nominal size (Standard)

Thread nominal size	Applicable cylinder nominal thread size
8-125	M8 x 1.25
10-125	M10 x 1.25
14-150	M14 x 1.5
18-150	M18 x 1.5

Specifications

Operating pressure	Pneumatic cylinder: 1 MPa or less
Mounting	Basic type
Operating temperature	-10 to 70°C

Operating range

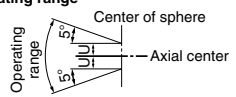

Construction

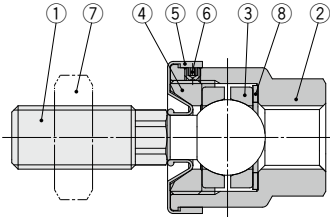

No.	Description	Material	Note
1	Stud	Steel	Manganese phosphate
2	Case	Aluminum	Chromated
3	Ring	Steel	
4	Cap	Steel	Black zinc chromated
5	Dust cover	Synthetic rubber	
6	Set screw	Steel	Zinc chromated
7	Rod end nut	Steel	Zinc chromated
8	Washer	Steel	

Dimensions

JC20 to 63

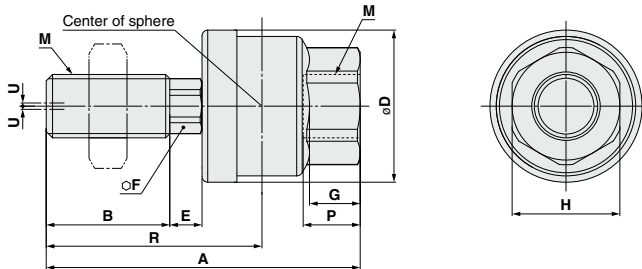

Standard type Pneumatic: to 1 MPa

Applicable cylinder bore size	Model	M		A	B	D	E	F	G	H	Center of sphere R	Maximum thread depth P	Allowable eccentricity U	Maximum operating tensile and compressive force N	Weight kg
		Nominal size	Pitch												
20	JC20-8-125	8	1.25	44	17.5	21	4.5	7	7	13	30.5	8	0.5	300	0.03
25, 32	JC30-10-125	10	1.25	49.5	19.5	24	5	8	8	17	34	9	0.5	800	0.05
40	JC40-14-150	14	1.5	60	20	31	6	11	11	22	38	13	0.75	1250	0.12
50, 63	JC63-18-150	18	1.5	74.5	25	41	7.5	14	13.5	27	47.5	15	1	3100	0.23

Semi-standard type Pneumatic: to 1 MPa

Applicable cylinder bore size	Model	M		A	B	D	E	F	G	H	Center of sphere R	Maximum thread depth P	Allowable eccentricity U	Maximum operating tensile and compressive force N	Weight kg
		Nominal size	Pitch												
20	JC20-8-100	8	1	44	17.5	21	4.5	7	7	13	30.5	8	0.5	300	0.03
25	JC25-10-150	10	1.5	49.5	19.5	24	5	8	8	17	34	9	0.5	800	0.05
32	JC32-10-100	10	1	49.5	19.5	24	5	8	8	17	34	9	0.5	800	0.05
32, 40	JC40-12-125	12	1.25	60	20	31	6	11	11	22	38	13	0.75	1250	0.11
40	JC40-12-150	12	1.5	60	20	31	6	11	11	22	38	13	0.75	1250	0.11
32, 40	JC40-12-175	12	1.75	60	20	31	6	11	11	22	38	13	0.75	1250	0.11
50	JC50-16-150	16	1.5	71.5	22	41	7.5	14	13.5	27	44.5	15	1	3100	0.22
50, 63	JC63-16-200	16	2	71.5	22	41	7.5	14	13.5	27	44.5	15	1	3100	0.22

Dimensions of Accessories

Rod end nut

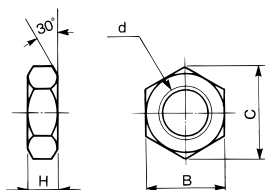

(mm)					
Model	Order number	d: Thread nominal size	H	B	C
JC20-8-100	DA00207	M8 x 1	5	13	15
JC20-8-125	DA00169	M8 x 1.25	5	13	15
JC32-10-100	DA00141	M10 x 1	6	17	19.6
JC30-10-125	DA00142	M10 x 1.25	6	17	19.6
JC25-10-150	DA00140	M10 x 1.5	6	17	19.6
JC40-12-125	DA00145	M12 x 1.25	7	19	21.9
JC40-12-150	DA00146	M12 x 1.5	7	19	21.9
JC40-12-175	DA00143	M12 x 1.75	7	19	21.9
JC40-14-150	DA00148	M14 x 1.5	8	22	25.4
JC50-16-150	DA00151	M16 x 1.5	10	24	27.7
JC63-16-200	DA00150	M16 x 2	10	24	27.7
JC63-18-150	DA00153	M18 x 1.5	11	27	31.2

Spare parts

● Rod end nut

The basic type has one rod end nut attached, it is possible to order additional pieces by the above order numbers.

● Dust cover

When the dust cover is damaged and deteriorated, order with the part number as shown below.

Part no. for dust cover	Applicable model
P215215	JC20
P215225	JC25, JC30, JC32
P215235	JC40
P215245	JC50, JC63



Specific Product Precautions

Be sure to read this before handling the products. Refer to page 20 for safety instructions and pages 21 to 25 for actuator precautions.

Mounting

Warning

1. To screw the male threads of the rod into the female threads of the socket or the case, make sure that it does not bottom out.

If the floating joint is used with its rod bottomed out, the stud will not be able to float, causing damage.

For the screw-in depth of the female threads, refer to the dimensions (page 1229). As a rule, after the rod bottoms out, back off 1 to 2 turns.

2. The dust cover may stick to the stud. Move the dust cover at the base of the stud with fingers, or twist the stud right and left gently to free them.

And when screwing stud or socket, or case in the driven object, make sure to screw them in the state that dust cover has been removed from the case. If screwing without removing dust cover, dust cover might be broken.

3. To use a floating joint to connect the cylinder rod to a driven body, secure it in place by applying a torque that is appropriate for the thread size. Also, if there is a risk of loosening during operation, take measures to prevent loosening, such as using a locking pin or thread adhesive.

In the event that the connected portion becomes loose, the driven body might lose control or fall off, leading to equipment damage or injury to personnel.

4. This product is dedicated to the linear motion. The threaded portion can be rotated, but this product is not a fitting designed for rotational axis. So, do not use for rotational applications.

5. Use the product at 25% or less of the allowable kinetic energy of the cylinder. When a driven object is stopped, be sure to prevent the impact force of the object being transferred to the product by adding the cushion mechanism of a cylinder or other cushioning devices such as a shock absorber. Otherwise, the impact force may exceed the maximum tensile and compressive force of the product, causing breakage.

Design

Warning

1. JC series has play in the axial direction. (Default: 0.06 mm or less)

When positioning the driven object, avoid the influence of play using a knock pin or external stopper.

Maintenance

Warning

1. Do not reuse if disassembled.

High strength adhesive is applied to the portion of the connection that is threaded to prevent it from loosening, and it must not be disassembled. If it is forcefully disassembled, it could lead to damage.

Floating Joint

JA/JAH/JB/JS Series



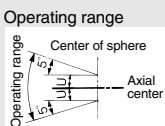
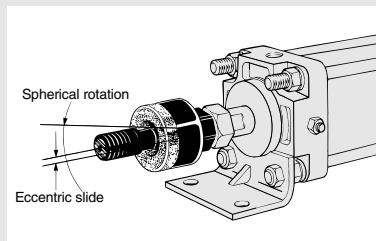

RoHS

The floating joint can absorb any “off-centering” or “loss of parallel accuracy” between the cylinder and the driven body.

- Centering is unnecessary.
- A high level of machining accuracy is unnecessary.
- The installation time is dramatically reduced.
- It is compact and is suitable for high tensile stresses.
- Long service life (with dustproof cover)
- Rotating angle..... $\pm 5^\circ$



Series Variations

Series	Cylinder supply pressure	Applicable bore size (mm)	Mounting	Page	
Standard JA Series 	Pneumatic cylinder	0.7 MPa or less	6, 10, 15	Basic type Flange type Foot type	1234
		1 MPa or less			
	Hydraulic cylinder	3.5 MPa or less	20, 25, 30, 40, 50, 63 80, 100, 125, 140, 160		
Heavy load JAH Series 	Hydraulic cylinder	7 MPa or less	40, 50, 63, 80, 100	Basic type Flange type Foot type	1241
For compact cylinders JB Series 	Pneumatic cylinder	1 MPa or less	12, 16, 20, 25, 32 40, 50, 63, 80, 100	Basic type (Female thread)	1244
Stainless steel type JS Series 	Pneumatic cylinder	1 MPa or less	10, 16, 20, 25 32, 40, 50, 63	Basic type	1246
		Hydraulic cylinder	3.5 MPa or less		

Floating Joint: Standard Type

JA Series



RoHS

Specifications

Operating pressure	Pneumatic cylinder>Note): 1 MPa or less, 0.7 MPa or less
	Hydraulic cylinder: 3.5 MPa or less
Mounting	Basic type, Flange type, Foot type

Operating range

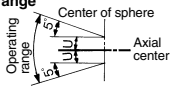

Note) The operating pressure varies according to the cylinder bore size.
Refer to page 1233 for details.

Model/Specifications

Model	Applicable bore size (mm)	Applicable cylinder nominal thread size	Maximum operating tension and compression force (N)			Allowable eccentricity U (mm)	Rotating angle	Ambient temperature
			Basic type	Flange type	Foot type			
Standard/Thread nominal size								
JA6-3-050	6	M3 x 0.5	19	—	—	0.5	±5°	-5 to 60°C
JA10-4-070	10	M4 x 0.7	54	—	—	0.5		
JA15-5-080	10, 15	M5 x 0.8	123	—	—	0.5		
JA15-6-100	15	M6 x 1	123	—	—	0.5		
JA□20-8-125	20	M8 x 1.25	1100	1100	1000	0.5		
JA□30-10-125	25, 32	M10 x 1.25	2500	2500	2000	0.5		
JA□40-14-150	40	M14 x 1.5	4400	4400	4400	0.75		
JA□63-18-150	50, 63	M18 x 1.5	11000	11000	9000	1		
JA□80-22-150	80	M22 x 1.5	18000	18000	14000	1.25		
JA□100-26-150	100	M26 x 1.5	28000	28000	22000	2		
JA□140-30-150	125, 140	M30 x 1.5	54000	36000	36000	2.5		
JA□160-36-150	160	M36 x 1.5	71000	55000	55000	3		
Semi-standard/Thread nominal size								
JA□20-8-100	20	M8 x 1	1100	1100	1000	0.5	±5°	-5 to 60°C
JA□25-10-150	25	M10 x 1.5	2500	2500	2000	0.5		
JA□32-10-100	32	M10 x 1	2500	2500	2000	0.5		
JA□40-12-125	32, 40	M12 x 1.25	4400	4400	4400	0.75		
JA□40-12-150	40	M12 x 1.5	4400	4400	4400	0.75		
JA□40-12-175	32, 40	M12 x 1.75	4400	4400	4400	0.75		
JA□50-16-150	50	M16 x 1.5	11000	11000	9000	1		
JA□63-16-200	50, 63	M16 x 2	11000	11000	9000	1		
JA□80-20-250	80	M20 x 2.5	18000	18000	14000	1.25		
JA□100-24-300	100	M24 x 3	28000	28000	22000	2		
JA□100-27-150	100	M27 x 1.5	28000	28000	22000	2		
JA□125-27-200	125	M27 x 2	28000	28000	28000	2		
JA□160-33-200	160	M33 x 2	71000	55000	55000	3		



Precautions

Be sure to read this before handling the products. Refer to page 20 for safety instructions.

Mounting

Warning

- To screw the male threads of the rod into the female threads of the socket or the case, make sure that it does not bottom out. If the floating joint is used with its rod bottom out, the stud will not be able to float, causing damage.
For the screw-in depth of the female threads, refer to the dimensions (page 1236). As a rule, after the rod bottoms out, back off 1 to 2 turns.
- The dust cover may adhere to the stud. In this case, move the dust cover at the neck of the stud by the finger or twist the stud slightly left or right to break in the dust cover before use.
Additionally, when screwing the stud and socket or the case into a driven body, screw in such parts with the dust cover removed. When screwing in such parts without removing the dust cover, this may cause damage to the dust cover.
- To use a floating joint to connect the cylinder rod to a driven body, secure it in place by applying a torque that is appropriate for the thread size. Also, if there is a risk of loosening during operation, take measures to prevent loosening, such as using a locking pin or thread adhesive. In the event that the connected portion becomes loose, the driven body might lose control or fall off, leading to equipment damage or injury to personnel.
- This product is not a rotary joint. So, the product cannot be used for rotational or rotation acting applications.
- Be sure to use the cushion mechanism of the cylinder or the buffer mechanism, such as the shock absorber so that any impact force is not applied to the floating joint when stopping a driven body. If there is no buffer mechanism, an excessive impact force is generated. As a result, the tensile compression force of the floating joint may exceed its maximum level.

Maintenance

Warning

- Do not reuse if disassembled.
The threaded part cannot be removed from the rest of the joint as they are either welded together or held together using high-strength adhesive. Attempting to forcefully disassemble the joint may result in damage.

Caution

- The black zinc chromate treatment is applied to the material surfaces of the case, flange and foot. However, the white deposit may rarely occur on the surface. This white deposit does not affect the product functions. However, if the white deposit becomes a problem from a viewpoint of appearance, special products with the surface treatment changed to the electroless nickel plating are also available. For details, please contact SMC.

How to Order

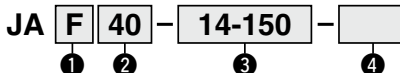

1 Mounting type

Nil	Basic type
F	Flange type
L	Foot type

4 Option

Nil	None
X11	High temperature specifications -5 to 100°C

2 Applicable bore size (mm)

Model	Symbol	Applicable bore size (mm)
Standard	6	6
	10	10
	15	10, 15
	20	20
	30	25, 32
	40	40
	63	50, 63
	80	80
	100	100
	140	125, 140
160	160	
180	180	
200	200	

3 Thread nominal size (Standard)

Nominal thread size	Applicable cylinder nominal thread size
3-050	M3 x 0.5
4-070	M4 x 0.7
5-080	M5 x 0.8
6-100	M6 x 1
8-125	M8 x 1.25
10-125	M10 x 1.25
14-150	M14 x 1.5
18-150	M18 x 1.5
22-150	M22 x 1.5
26-150	M26 x 1.5
30-150	M30 x 1.5
36-150	M36 x 1.5

Made to Order: Individual Specifications -X530

Note) For details, refer to page 1239. For pneumatic cylinders

Design

Warning

- JA series has play in the axial direction. (Default: 0.06 mm or less)
When positioning the driven object, avoid the influence of play using a knock pin or external stopper.

Construction

ø6 to ø15

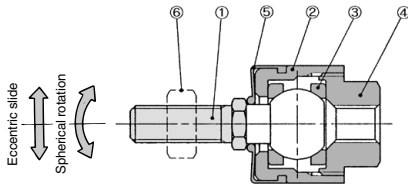

ø20 to ø160

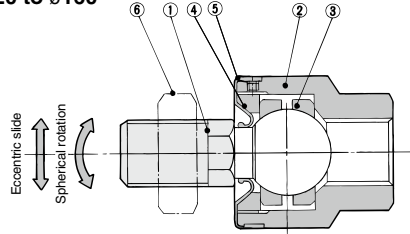

Component Parts

No.	Description	Material	Note
1	Stud	Free-cutting steel	Electroless nickel plated
2	Case	Brass	Electroless nickel plated
3	Ring	Stainless steel	
4	Socket	Brass	Electroless nickel plated
5	Dust cover	Synthetic rubber	
6	Rod end nut	Low carbon steel wire rod	Zinc chromated

No.	Description	Material	Note
1	Stud	Chromium molybdenum steel	Dyed black
2	Case	Carbon steel	Black zinc chromated
3	Ring	Chromium molybdenum steel	
4	Cap	Carbon steel	Black zinc chromated
5	Dust cover	Synthetic rubber	
6	Rod end nut	Carbon steel	Zinc chromated
7	Flange	Rolled steel	Black zinc chromated
8	Foot	Rolled steel	Black zinc chromated

Accessory Dimensions

Rod end nut

One rod end nut is supplied with the JA series or JAH basic type. If additional nuts are needed, please order them using the part no. shown below.

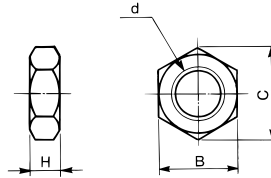

(mm)

Model	Order no.	d: Thread nominal size	H	B	C
JA6-3-050	DA00201	M3x0.5	2.4	5.5	6.4
JA10-4-070	DA00117	M4x0.7	3.2	7	8.1
JA15-5-080	DA00118	M5x0.8	4	8	9.2
JA15-6-100	DA00119	M6x1	5	10	11.5
JA20-8-100	DA00207	M8x1	5	13	15
JA20-8-125	DA00169	M8x1.25	5	13	15
JA32-10-100	DA00141	M10x1	6	17	19.6
JA30-10-125	DA00142	M10x1.25	6	17	19.6
JA25-10-150	DA00140	M10x1.5	6	17	19.6
JA40-12-125	DA00145	M12x1.25	7	19	21.9
JA40-12-150	DA00146	M12x1.5	7	19	21.9
JA40-12-175	DA00143	M12x1.75	7	19	21.9
JA40-14-150	DA00148	M14x1.5	8	22	25.4
JA50-16-150	DA00151	M16x1.5	10	24	27.7
JAH40-16-150					
JA63-16-200	DA00150	M16x2	10	24	27.7
JA63-18-150	DA00153	M18x1.5	11	27	31.2

(mm)

Model	Order no.	d: Thread nominal size	H	B	C
JAH50-20-150	DA00155	M20x1.5	12	30	34.6
JA80-20-250	DA00154	M20x2.5	12	30	34.6
JA80-22-150	DA00156	M22x1.5	13	32	37
JAH63-24-150	DA00158	M24x1.5	14	36	41.6
JAH63-24-200	DA00159	M24x2	14	36	41.6
JA100-24-300	DA00157	M24x3	14	36	41.6
JA100-26-150	DA00160	M26x1.5	16	41	47.3
JA100-27-150	DA00161	M27x1.5	16	41	47.3
JA125-27-200	DA00162	M27x2	16	41	47.3
JA140-30-150	DA00224	M30x1.5	18	46	53.1
JAH80-30-150					
JAH80-30-200	DA00163	M30x2	18	46	53.1
JA160-33-200	DA00225	M33x2	20	50	57.7
JA160-36-150	DA00164	M36x1.5	21	55	63.5
JAH100-39-150	DA00204	M39x1.5	23	60	69.3
JAH100-42-300	DA00165	M42x3	25	65	75
JAH100-48-150	DA00205	M48x1.5	29	75	86.5

Floating Joint Replacement Parts

Dust cover

Order with the following part no. if dust cover is damaged. Replaceable dust cover is only for the basic type. Flange type and foot type cannot be replaced.

Part no. for dust cover	Applicable model
P2152051	JA6, JA10
P2152052	JA15, JB12, JB16
P215215	JA20, JB20
P215225	JA30, JB25
P215235	JA40, JB40
P215245	JA63, JA50, JB63

Part no. for dust cover	Applicable model
P215255	JA80, JAH40, JB80
P215265	JA100, JAH50, JB100
P215275	JA125, JAH63
P215285	JA140, JAH80, JB140
P215295	JA160, JAH100, JB160

Basic Type: JA6 to JA160

JA6 to 15

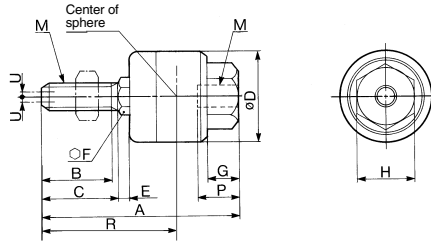

Use the precision spanner for clock 4 mm in the case of mounting male thread of JA6 and JA10.

JA20 to 160

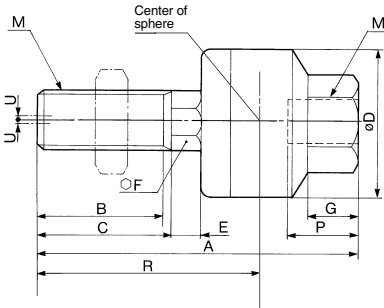

Without C-dimension

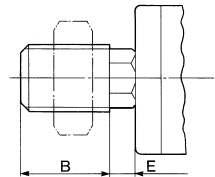
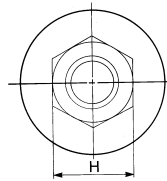

Applicable bore size (mm)	Model	M		A	B	C	D	E	F	G	H	Center of sphere R	Maximum thread depth P	Allowable eccentricity U	Maximum operating tension and compression force (N)	Weight (kg)
		Nominal size	Pitch													
Standard Pneumatic: Up to 1 MPa, Up to 0.7 MPa ^(Note) Hydraulic: Up to 3.5 MPa ^{Note} The operating pressure varies according to the cylinder bore size. Refer to page 1233 for details.																
6	JA6-3-050	3	0.5	23.2	7	8	12	1.5	4	3.2	5.5	15	5	0.5	19	0.01
10 (CJ1)	JA10-4-070	4	0.7	26	9	10	12	1.5	4	4	7	17	5.5	0.5	54	0.01
10 (CZ1), 15 (CJ1)	JA15-5-080	5	0.8	34.5	12.5	14	16	2	6	5	10	23	7	0.5	123	0.02
15 (CZ1)	JA15-6-100	6	1	34.5	12.5	14	16	2	6	5	10	23	7	0.5	123	0.02
20	JA20-8-125	8	1.25	44	17.5	—	21	4.5	7	7	13	30.5	8	0.5	1100	0.05
25, 32	JA30-10-125	10	1.25	49.5	19.5	—	24	5	8	8	17	34	9	0.5	2500	0.07
40	JA40-14-150	14	1.5	60	20	—	31	6	11	11	22	38	13	0.75	4400	0.16
50, 63	JA63-18-150	18	1.5	74.5	25	—	41	7.5	14	13.5	27	47.5	15	1	11000	0.31
80	JA80-22-150	22	1.5	89.5	29	—	50	9.5	19	16	32	56.5	18	1.25	18000	0.58
100	JA100-26-150	26	1.5	110	35	—	59.5	11.5	24	20	41	68	24	2	28000	1.08
125, 140	JA140-30-150	30	1.5	152	42	45	79	14	30	22	46	94.5	38	2.5	54000	2.7
160	JA160-36-150	36	1.5	178	52	55	96	16	36	24	55	112	42	3	71000	4.7

Semi-standard Pneumatic: Up to 1 MPa Hydraulic: Up to 3.5 MPa

20	JA20-8-100	8	1	44	17.5	—	21	4.5	7	7	13	30.5	8	0.5	1100	0.05
25	JA25-10-150	10	1.5	49.5	19.5	—	24	5	8	8	17	34	9	0.5	2500	0.07
32	JA32-10-100	10	1	49.5	19.5	—	24	5	8	8	17	34	9	0.5	2500	0.07
32, 40	JA40-12-125	12	1.25	60	20	—	31	6	11	11	22	38	13	0.75	4400	0.16
40	JA40-12-150	12	1.5	60	20	—	31	6	11	11	22	38	13	0.75	4400	0.16
32, 40	JA40-12-175	12	1.75	60	20	—	31	6	11	11	22	38	13	0.75	4400	0.16
50	JA50-16-150	16	1.5	71.5	22	—	41	7.5	14	13.5	27	44.5	15	1	11000	0.3
50, 63	JA63-16-200	16	2	71.5	22	—	41	7.5	14	13.5	27	44.5	15	1	11000	0.3
80	JA80-20-250	20	2.5	90.5	27	30	50	9.5	19	16	32	57.5	18	1.25	18000	0.6
100	JA100-24-300	24	3	110	32	35	59.5	11.5	24	20	41	68	24	2	28000	1.05
100	JA100-27-150	27	1.5	110	35	—	59.5	11.5	24	20	41	68	24	2	28000	1.08
125	JA125-27-200	27	2	123	34	38	66	13	24	20	41	77	24	2	28000	1.5
160	JA160-33-200	33	2	165	38	42	96	16	36	24	55	99	42	3	71000	4.5

Flange Type: JAF20 to JAF160

JAF20 to ø40

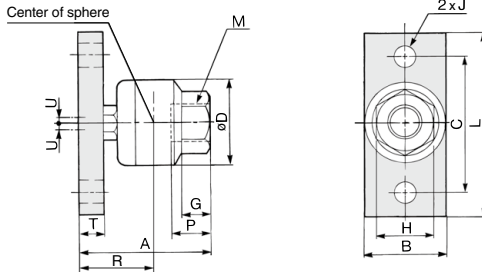

øJAF50 to ø160

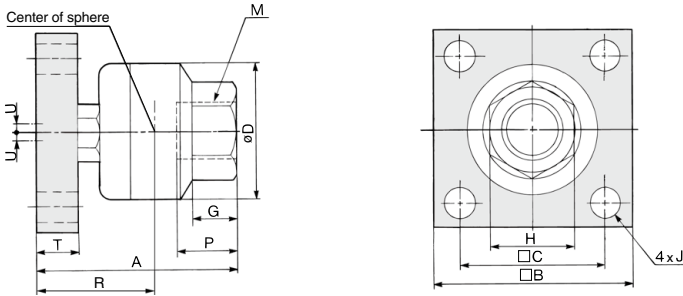

Applicable bore size (mm)	Model	M		A	B	L	C	D	T	J	G	H	Center of sphere R	Maximum thread depth P	Allowable eccentricity U	Maximum operating tension and compression force (N)	Weight (kg)
		Nominal size	Pitch														
Standard Pneumatic: Up to 1 MPa Hydraulic: Up to 3.5 MPa																	
20	JAF20-8-125	8	1.25	32.5	19	48	36	21	6	6.6	7	13	19	8	0.5	1100	0.08
25, 32	JAF30-10-125	10	1.25	36	25	52	40	24	6	6.6	8	17	20.5	9	0.5	2500	0.12
40	JAF40-14-150	14	1.5	49	32	70	52	31	9	9	11	22	27	13	0.75	4400	0.28
50, 63	JAF63-18-150	18	1.5	61.5	65	-	45	41	12	9	13.5	27	34.5	15	1	11000	0.63
80	JAF80-22-150	22	1.5	76.5	75	-	55	50	16	11	16	32	43.5	18	1.25	18000	1.15
100	JAF100-26-150	26	1.5	94	90	-	65	59.5	19	11	20	41	52	24	2	28000	2.07
125, 140	JAF140-30-150	30	1.5	131	125	-	82	79	24	18	22	46	73.5	38	2.5	36000	5.2
160	JAF160-36-150	36	1.5	152	150	-	100	96	29	22	24	55	86	42	3	55000	9

Semi-standard Pneumatic: Up to 1 MPa Hydraulic: Up to 3.5 MPa

20	JAF20-8-100	8	1	32.5	19	48	36	21	6	6.6	7	13	19	8	0.5	1100	0.08
25	JAF25-10-150	10	1.5	36	25	52	40	24	6	6.6	8	17	20.5	9	0.5	2500	0.12
32	JAF32-10-100	10	1	36	25	52	40	24	6	6.6	8	17	20.5	9	0.5	2500	0.12
32, 40	JAF40-12-125	12	1.25	49	32	70	52	31	9	9	11	22	27	13	0.75	4400	0.28
40	JAF40-12-150	12	1.5	49	32	70	52	31	9	9	11	22	27	13	0.75	4400	0.28
32, 40	JAF40-12-175	12	1.75	49	32	70	52	31	9	9	11	22	27	13	0.75	4400	0.28
50	JAF50-16-150	16	1.5	61.5	65	-	45	41	12	9	13.5	27	34.5	15	1	11000	0.63
50, 63	JAF63-16-200	16	2	61.5	65	-	45	41	12	9	13.5	27	34.5	15	1	11000	0.63
80	JAF80-20-250	20	2.5	76.5	75	-	55	50	16	11	16	32	43.5	18	1.25	18000	1.15
100	JAF100-24-300	24	3	94	90	-	65	59.5	19	11	20	41	52	24	2	28000	2.07
100	JAF100-27-150	27	1.5	94	90	-	65	59.5	19	11	20	41	52	24	2	28000	2.07
125	JAF125-27-200	27	2	106	100	-	72	66	21	18	20	41	60	24	2	28000	2.8
160	JAF160-33-200	33	2	152	150	-	100	96	29	22	24	55	86	42	3	55000	9

Foot Type: JAL20 to JAF160

JAL20 to 100

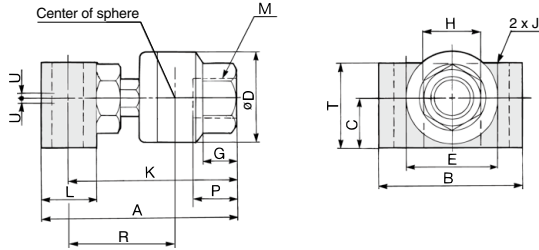

JAL125 to 160

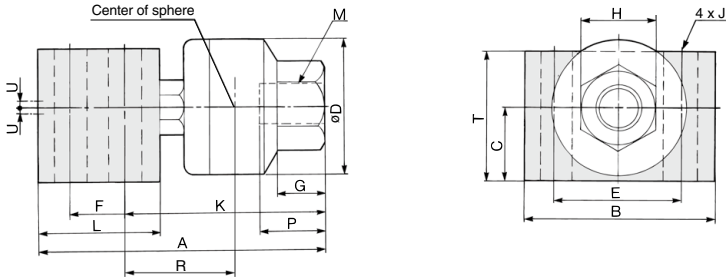

Applicable bore size (mm)	Model	M		A	B	C	D	E	F	K	L	T	J	G	H	Center of sphere R	Maximum thread depth P	Allowable eccentricity U	Maximum operating tension and compression force (N)	Weight (kg)
		Nominal size	Pitch																	
Standard Pneumatic: Up to 1 MPa Hydraulic: Up to 3.5 MPa																				
20	JAL20-8-125	8	1.25	44	30	11.5	21	18	-	38	12	19	6.6	7	13	24.5	8	0.5	1000	0.09
25, 32	JAL30-10-125	10	1.25	52	42	14	24	24	-	44	16	25	9	8	17	28.5	9	0.5	2000	0.18
40	JAL40-14-150	14	1.5	67	52	17.5	31	30	-	57.5	19	30	11	11	22	35.5	13	0.75	4400	0.36
50, 63	JAL63-18-150	18	1.5	82.5	56	23	41	34	-	71.5	22	38	11	13.5	27	44.5	15	1	9000	0.61
80	JAL80-22-150	22	1.5	98.5	70	28	50	42	-	86	25	47	14	16	32	53	18	1.25	14000	1.09
100	JAL100-26-150	26	1.5	123	80	35	59.5	48	-	107	32	58	16	20	41	65	24	2	22000	2.03
125, 140	JAL140-30-150	30	1.5	187	96	45	79	60	44	125	80	79	18	22	46	67.5	38	2.5	36000	6.4
160	JAL160-36-150	36	1.5	213	116	55	96	74	48	144	90	89	22	24	55	78	42	3	55000	10
Semi-standard Pneumatic: Up to 1 MPa Hydraulic: Up to 3.5 MPa																				
20	JAL20-8-100	8	1	44	30	11.5	21	18	-	38	12	19	6.6	7	13	24.5	8	0.5	1000	0.09
25	JAL25-10-150	10	1.5	52	42	14	24	24	-	44	16	25	9	8	17	28.5	9	0.5	2000	0.18
32	JAL32-10-100	10	1	52	42	14	24	24	-	44	16	25	9	8	17	28.5	9	0.5	2000	0.18
32, 40	JAL40-12-125	12	1.25	67	52	17.5	31	30	-	57.5	19	30	11	11	22	35.5	13	0.75	4400	0.36
40	JAL40-12-150	12	1.5	67	52	17.5	31	30	-	57.5	19	30	11	11	22	35.5	13	0.75	4400	0.36
32, 40	JAL40-12-175	12	1.75	67	52	17.5	31	30	-	57.5	19	30	11	11	22	35.5	13	0.75	4400	0.36
50	JAL50-16-150	16	1.5	82.5	56	23	41	34	-	71.5	22	38	11	13.5	27	44.5	15	1	9000	0.61
50, 63	JAL63-16-200	16	2	82.5	56	23	41	34	-	71.5	22	38	11	13.5	27	44.5	15	1	9000	0.61
80	JAL80-20-250	20	2.5	98.5	70	28	50	42	-	86	25	47	14	16	32	53	18	1.25	14000	1.09
100	JAL100-24-300	24	3	123	80	35	59.5	48	-	107	32	58	16	20	41	65	24	2	22000	2.03
100	JAL100-27-150	27	1.5	123	80	35	59.5	48	-	107	32	58	16	20	41	65	24	2	22000	2.03
125	JAL125-27-200	27	2	155	88	38	66	54	36	102	70	69	14	20	41	56	24	2	28000	4.1
160	JAL160-33-200	33	2	213	116	55	96	74	48	144	90	89	22	24	55	78	42	3	55000	10



Please contact SMC for detailed dimensions, specifications and lead times.

1 For Pneumatic Cylinders (ø180, ø200)

Symbol
-X530

JA series standard type floating joint which is used for pneumatic cylinders (ø180, ø200)

* This product is dedicated to the pneumatic cylinders.



Model/Specifications

Applicable bore size (mm)	Model	Applicable cylinder nominal thread size	Maximum operating tensile and compressive force (N)			Allowable eccentricity (U)	Rotating angle	Ambient temperature
			Basic type	Flange type	Foot type			
180	JA□180-40-150-X530	M40 x 1.5	71000	55000	55000	3	5°	-5 to 60°C
200	JA□200-45-150-X530	M45 x 1.5						

Specifications

Operating pressure	Pneumatic cylinder: 1 MPa or less
Mounting	Basic type, Flange type, Foot type
Operating range 	

How to Order

JA F 180 - 40-150 - X530

Mounting type

Nil	Basic type
F	Flange type
L	Foot type

Applicable bore size

Symbol	Applicable bore size
180	180 mm
200	200 mm

Nominal thread size

Nominal thread size	Applicable cylinder nominal thread size
40-150	M40 x 1.5
45-150	M45 x 1.5

For pneumatic cylinders (ø180, ø200)

Basic Type: JA

JA ¹⁸⁰/₂₀₀ - □ - X530

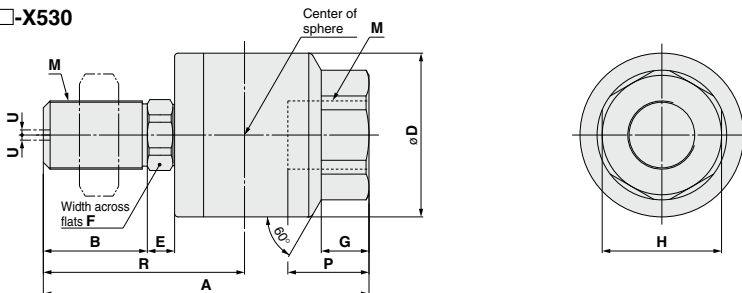

Dimensions

Applicable bore size	Model	M		A	B	D	E	F	G	H	Center of sphere R	Maximum screw-in depth P	Allowable eccentricity U	Maximum operating tensile and compressive force (N)	Weight (kg)
		Nominal size	Pitch												
180	JA180-40-150-X530	40	1.5	191	61	96	16	36	28	70	118	49	3	71000	5.3
200	JA200-45-150-X530	45	1.5	191	61	96	16	36	28	70	118	49	3	71000	5.4

JA Series

Flange Type: JAF

JAF ¹⁸⁰/₂₀₀ □-X530

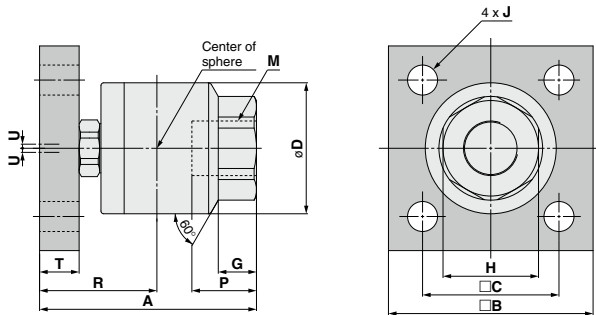

Dimensions

Applicable bore size	Model	M		A	B	C	D	T	J	G	H	Center of sphere R	Maximum screw-in depth P	Allowable eccentricity U	Maximum operating tensile and compressive force (N)	Weight (kg)
		Nominal size	Pitch													
180	JAF180-40-150-X530	40	1.5	159	150	100	96	29	22	28	70	86	49	3	55000	9.1
200	JAF200-45-150-X530	45	1.5	159	150	100	96	29	22	28	70	86	49	3	55000	9.2

Foot Type: JAL

JAL ¹⁸⁰/₂₀₀ □-X530

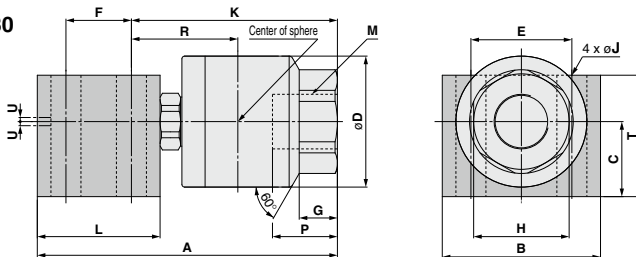

Dimensions

Applicable bore size	Model	M		A	B	C	D	E	F	K	L	T	J	G	H	Center of sphere R	Maximum screw-in depth P	Allowable eccentricity U	Maximum operating tensile and compressive force (N)	Weight (kg)
		Nominal size	Pitch																	
180	JAL180-40-150-X530	40	1.5	220	116	55	96	74	48	151	90	89	22	28	70	78	49	3	55000	10.3
200	JAL200-45-150-X530	45	1.5	220	116	55	96	74	48	151	90	89	22	28	70	78	49	3	55000	10.4

Rod End Nut

The basic type has one rod end nut attached, it is possible to order additional pieces by the order numbers below.

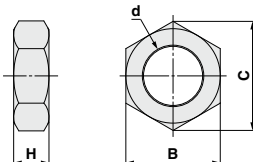

Model	Order no.	d: Nominal thread size	H	B	C
JA180-40-150-X530	DA00425	M40 x 1.5	23	60	69.3
JA200-45-150-X530	DA00447	M45 x 1.5	27	70	80.8

Floating Joint Replacement Parts

Dust cover

When the dust cover is damaged and deteriorated, order with the part number below.

Replaceable dust cover is only for the basic type. Flange type and foot type cannot be replaced.

Part no. for dust cover	Applicable model
P215295	JA180, 200 □-X530

Floating Joint: Heavy Load Type

JAH Series

RoHS

Specifications

Operating pressure	Hydraulic cylinder: 7 MPa or less
Mounting	Basic type, Flange type, Foot type

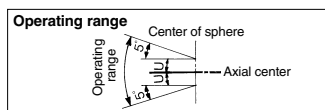

JAH series



JAHL series
(Foot type)



JAHF series
(Flange type)

⚠ Precautions

Be sure to read this before handling the products. Refer to page 20 for safety instructions.

Mounting

⚠ Warning

- To screw the male threads of the rod into the female threads of the socket or the case, make sure that it does not bottom out. If the floating joint is used with its rod bottomed out, the stud will not be able to float, causing damage. For the screw-in depth of the female threads, refer to the dimensions (page 1242). As a rule, after the rod bottoms out, back off 1 to 2 turns.
- The dust cover may adhere to the stud. In this case, move the dust cover at the neck of the stud by the finger or twist the stud slightly left or right to break in the dust cover before use. Additionally, when screwing the stud and socket or the case into a driven body, screw in such parts with the dust cover removed. When screwing in such parts without removing the dust cover, this may cause damage to the dust cover.
- To use a floating joint to connect the cylinder rod to a driven body, secure it in place by applying a torque that is appropriate for the thread size. Also, if there is a risk of loosening during operation, take measures to prevent loosening, such as using a locking pin or thread adhesive.

Specifications

Model	Applicable bore size (mm)	Applicable cylinder nominal thread size	Maximum operating tension and compression force (N)			Allowable eccentricity U (mm)	Rotating angle	Ambient temperature		
			Basic type	Flange type	Foot type					
Standard/Thread nominal size										
JAH□40-16-150	40	M16 x 1.5	11000	9000	9000	1.25	±5° -5 to 60°C			
JAH□50-20-150	50	M20 x 1.5	18000	14000	14000	2				
JAH□63-24-150	63	M24 x 1.5	28000	22000	22000	2				
JAH□80-30-150	80	M30 x 1.5	54000	36000	36000	2.5				
JAH□100-39-150	100	M39 x 1.5	71000	55000	55000	3				
JAH□100-48-150	100	M48 x 1.5	71000	55000	55000	3	±5°			
Semi-standard/Thread nominal size										
JAH□63-24-200	63	M24 x 2	28000	22000	22000	2				
JAH□80-30-200	80	M30 x 2	54000	36000	36000	2.5				
JAH□100-42-300	100	M42 x 3	71000	55000	55000	3				

How to Order

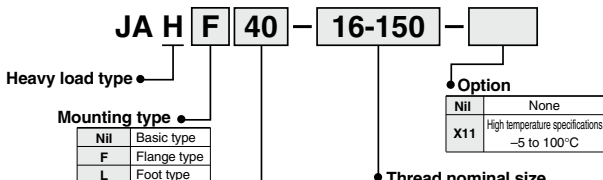

● Thread nominal size (Standard)

Nominal thread size	Applicable cylinder nominal thread size
16-150	M16 x 1.5
20-150	M20 x 1.5
24-150	M24 x 1.5
30-150	M30 x 1.5
39-150	M39 x 1.5
48-150	M48 x 1.5

Applicable bore size (mm) ●

Model	Symbol	Applicable bore size (mm)
Heavy load type	40	40
	50	50
	63	63
	80	80
	100	100

In the event that the connected portion becomes loose, the driven body might lose control or fall off, leading to equipment damage or injury to personnel.

- This product is not a rotary joint. So, the product cannot be used for rotational or rotation acting applications.
- Be sure to use the cushion mechanism of the cylinder or the buffer mechanism, such as the shock absorber so that any impact force is not applied to the floating joint when stopping a driven body. If there is no buffer mechanism, an excessive impact force is generated. As a result, the tensile compression force of the floating joint may exceed its maximum level.

Maintenance

⚠ Warning

- Do not reuse if disassembled. High strength adhesive is applied to the portion of the connection that is threaded to prevent it from loosening, and it must not be disassembled. If it is forcefully disassembled, it could lead to damage.

⚠ Caution

- The black zinc chromate treatment is applied to the material surfaces of the case, flange and foot. However, the white deposit may rarely occur on the surface. This white deposit does not affect the product functions. However, if the white deposit becomes a problem from a viewpoint of appearance, special products with the surface treatment changed to the electroless nickel plating are also available. For details, please contact SMC.

Design

⚠ Warning

- JAH series has play in the axial direction. (Default: 0.06 mm or less) When positioning the driven object, avoid the influence of play using a knock pin or external stopper.

Construction

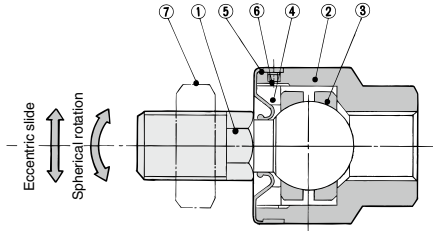

Refer to page 1235 for replacement Parts.

Component Parts

No.	Description	Material	Note
1	Stud	Chromium molybdenum steel	Dyed black
2	Case	Carbon steel	Black zinc chromated
3	Ring	Chromium molybdenum steel	
4	Cap	Carbon steel	Black zinc chromated
5	Dust cover	Synthetic rubber	
6	Set screw	Carbon steel	Zinc chromated
7	Rod end nut	Carbon steel	Zinc chromated
8	Flange	Rolled steel plate	Black zinc chromated
9	Foot	Rolled steel plate	Black zinc chromated

Basic Type: JAH

JAH40 to 100

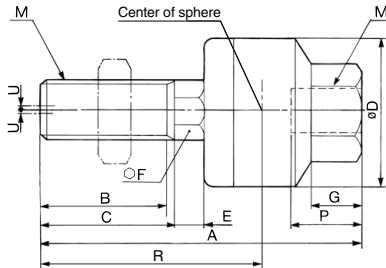

Without C-dimension

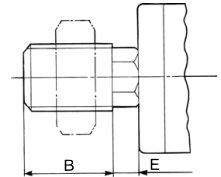

(mm)

Applicable bore size (mm)	Model	M		A	B	C	D	E	F	G	H	Center of sphere R	Maximum thread depth P	Allowable eccentricity U	Maximum operating tension and compression force (N)	Weight (kg)
		Nominal size	Pitch													

Standard: Heavy Load Type Hydraulic: Up to 7 MPa

40	JAH40-16-150	16	1.5	85.5	22	25	50	9.5	19	16	32	52.5	18	1.25	11000	0.58
50	JAH50-20-150	20	1.5	101	28	31	59.5	11.5	24	16	32	64	18	2	18000	1.08
63	JAH63-24-150	24	1.5	120	32	35	66	13	27	20	41	74	24	2	28000	1.5
80	JAH80-30-150	30	1.5	152	42	45	79	14	30	22	46	94.5	38	2.5	54000	2.7
100	JAH100-39-150	39	1.5	178	52	55	96	16	36	24	55	112	42	3	71000	4.8
100	JAH100-48-150	48	1.5	191	61	—	96	16	36	28	70	118	49	3	71000	5.4

Semi-standard: Heavy Load Type Hydraulic: Up to 7 MPa

63	JAH63-24-200	24	2	120	32	35	66	13	27	20	41	74	24	2	28000	1.5
80	JAH80-30-200	30	2	152	41	45	79	14	30	22	46	94.5	38	2.5	54000	2.7
100	JAH100-42-300	42	3	178	55	—	96	16	36	24	55	112	42	3	71000	4.8

Flange Type: JAHF

JAHF40 to 100

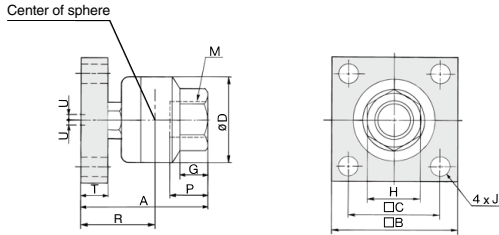

Applicable bore size (mm)	Model	M		A	B	C	D	T	J	G	H	Center of sphere R	Maximum thread depth P	Allowable eccentricity U	Maximum operating tension and compression force (N)	Weight (kg)
		Nominal size	Pitch													
Standard: Heavy Load Type Hydraulic: Up to 7 MPa																
40	JAHF40-16-150	16	1.5	76	75	50	50	15	11	16	32	43	18	1.25	9000	1.25
50	JAHF50-20-150	20	1.5	89	100	62	59.5	18	14	16	32	52	18	2	14000	2.5
63	JAHF63-24-150	24	1.5	106	100	72	66	21	18	20	41	60	24	2	22000	2.8
80	JAHF80-30-150	30	1.5	131	125	82	79	24	18	22	46	73.5	38	2.5	36000	5.2
100	JAHF100-39-150	39	1.5	152	150	100	96	29	22	24	55	86	42	3	55000	9
100	JAHF100-48-150	48	1.5	159	150	100	96	29	22	28	70	86	49	3	55000	9.3

Semi-standard: Heavy Load Type Hydraulic: Up to 7 MPa

63	JAHF63-24-200	24	2	106	100	72	66	21	18	20	41	60	24	2	22000	2.8
80	JAHF80-30-200	30	2	131	125	82	79	24	18	22	46	73.5	38	2.5	36000	5.2
100	JAHF100-42-300	42	3	152	150	100	96	29	22	24	55	86	42	3	55000	9

Foot Type: JAHL

JAHL40, 50

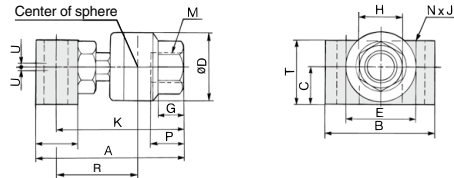

JAHL63 to 100

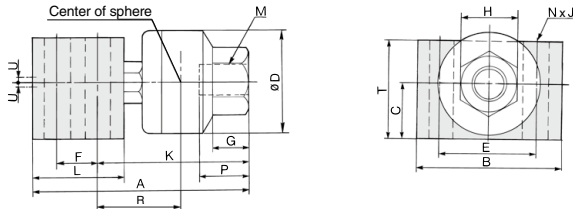

Applicable bore size (mm)	Model	M		A	B	C	D	E	F	K	L	T	N	J	G	H	Center of sphere R	Maximum thread depth P	Allowable eccentricity U	Maximum operating tension and compression force (N)	Weight (kg)
		Nominal size	Pitch																		
Standard: Heavy Load Type Hydraulic: Up to 7 MPa																					
40	JAHL40-16-150	16	1.5	98.5	70	28	50	42	—	86	25	47	2	14	16	32	53	18	1.25	9000	1.09
50	JAHL50-20-150	20	1.5	123	80	35	59.5	48	—	107	32	58	2	16	20	41	65	24	2	14000	2.03
63	JAHL63-24-150	24	1.5	155	88	38	66	54	36	102	70	69	4	18	20	41	56	24	2	22000	4.1
80	JAHL80-30-150	30	1.5	187	96	45	79	60	44	125	80	79	4	18	22	46	67.5	38	2.5	36000	6.4
100	JAHL100-39-150	39	1.5	213	116	55	96	74	48	144	90	89	4	22	24	55	78	42	3	55000	10
100	JAHL100-48-150	48	1.5	220	116	55	96	74	48	151	90	89	4	22	28	70	78	49	3	55000	10.5

Semi-standard: Heavy Load Type Hydraulic: Up to 7 MPa

63	JAHL63-24-200	24	2	155	88	38	66	54	36	102	70	69	4	18	20	41	56	24	2	22000	4.1
80	JAHL80-30-200	30	2	187	96	45	79	60	44	125	80	79	4	18	22	46	67.5	38	2.5	36000	6.4
100	JAHL100-42-300	42	3	213	116	55	96	74	48	144	90	89	4	22	24	55	78	42	3	55000	10

Floating Joint: For Compact Cylinders

JB Series

RoHS

Specifications

Operating pressure	Air pressure compact cylinder 1 MPa or less
---------------------------	--

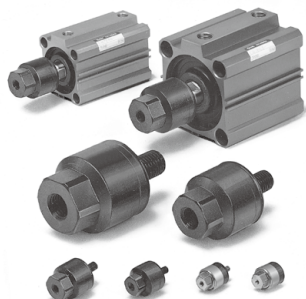
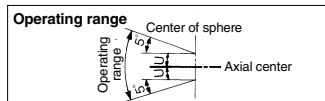

Specifications

Model	Applicable bore size (mm)	Applicable cylinder nominal thread size	Maximum operating tension and compression force (N)		Allowable eccentricity U (mm)	Rotating angle	Ambient temperature
			Compression side	Tension side			
JB12-3-050	12	M3 x 0.5	112	112	0.5	$\pm 5^\circ$	-5 to 60°C
JB16-4-070	16	M4 x 0.7	200	200	0.5		
JB20-5-080	20	M5 x 0.8	1100	300	0.5		
JB25-6-100	25	M6 x 1	2500	500	0.5		
JB40-8-125	32, 40	M8 x 1.25	6000	1300	0.75		
JB63-10-150	50, 63	M10 x 1.5	11000	3100	1		
JB80-16-200	80	M16 x 2	18000	5000	1.25		
JB100-20-250	100	M20 x 2.5	28000	7900	2		
JB140-22-250	125, 140	M22 x 2.5	54000	15300	2.5		
JB160-24-300	160	M24 x 3	71000	20000	3		

How to Order

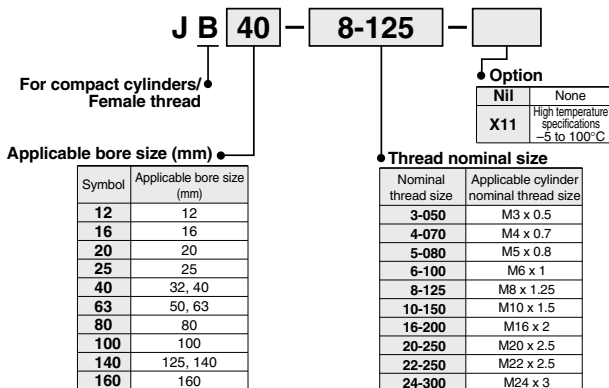

⚠ Precautions

Be sure to read this before handling the products. Refer to page 20 for safety instructions.

Mounting

⚠ Warning

- To screw the male threads of the rod into the female threads of the socket or the case, make sure that it does not bottom out. If the floating joint is used with its rod bottomed out, the stud will not be able to float, causing damage. For the screw-in depth of the female threads, refer to the dimensions (page 1245). As a rule, after the rod bottoms out, back off 1 to 2 turns.
- The dust cover may adhere to the stud. In this case, move the dust cover at the neck of the stud by the finger or twist the stud slightly left or right to break in the dust cover before use.
Additionally, when screwing the stud and socket or the case into a driven body, screw in such parts with the dust cover removed. When screwing in such parts without removing the dust cover, this may cause damage to the dust cover.
- To use a floating joint to connect the cylinder rod to a driven body, secure it in place by applying a torque that is appropriate for the thread size. Also, if there is a risk of loosening during operation, take measures to prevent loosening, such as using a locking pin or thread adhesive.
In the event that the connected portion becomes

loose, the driven body might lose control or fall off, leading to equipment damage or injury to personnel.

- This product is not a rotary joint. So, the product cannot be used for rotational or rotation acting applications.
- Be sure to use the cushion mechanism of the cylinder or the buffer mechanism, such as the shock absorber so that any impact force is not applied to the floating joint when stopping a driven body. If there is no buffer mechanism, an excessive impact force is generated. As a result, the tensile compression force of the floating joint may exceed its maximum level.

Maintenance

⚠ Warning

- Do not reuse if disassembled.
The threaded part cannot be removed from the rest of the joint as they are either welded together or held together using high-strength adhesive. Attempting to forcefully disassemble the joint may result in damage.

⚠ Caution

- The black zinc chromate treatment is applied to the material surfaces of the case, flange and foot. However, the white deposit may rarely occur on the surface. This white deposit does not affect the product functions. However, if the white deposit becomes a problem from a viewpoint of appearance, special products with the surface treatment changed to the electroless nickel plating are also available. For details, please contact SMC.

Design

⚠ Warning

- JB series has play in the axial direction. (Default: 0.06 mm or less)
When positioning the driven object, avoid the influence of play using a knock pin or external stopper.

Construction

ø12, ø16

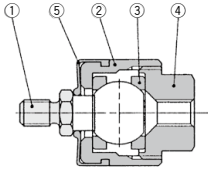

ø20 to ø160

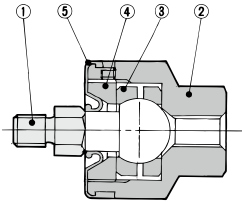

Component Parts

No.	Description	Material	Note
1	Stud	Free-cutting steel	Electroless nickel plated
2	Case	Brass	Electroless nickel plated
3	Ring	Stainless steel	
4	Socket	Brass	Electroless nickel plated
5	Dust cover	Synthetic rubber	

No.	Description	Material	Note
1	Stud	Chromium molybdenum steel	Dyed black
2	Case	Carbon steel	Black zinc chromated
3	Ring	Chromium molybdenum steel	
4	Cap	Carbon steel	Black zinc chromated
5	Dust cover	Synthetic rubber	

Refer to page 1235 for replacement Parts.

Basic Type: JB

JB12, 16

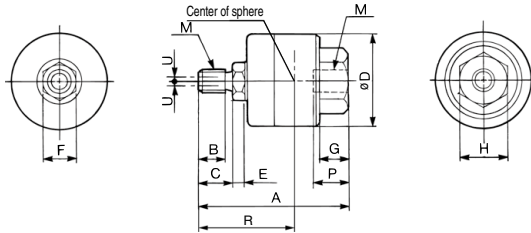

JB20 to 160

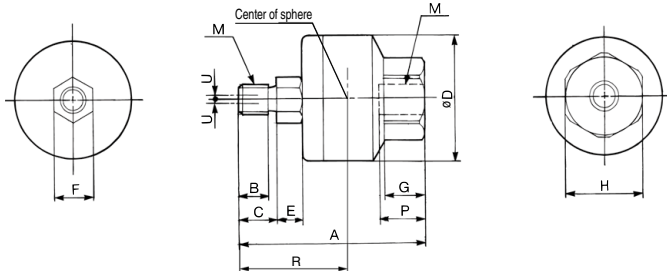

Applicable bore size (mm)	Model	M		A	B	C	D	E	F	G	H	Center of sphere R	Maximum thread depth P	Allowable eccentricity U	Maximum operating tension and compression force (N)		Weight (kg)
		Nominal size	Pitch												Compression	Tension	
12	JB12-3-050	3	0.5	24.5	3	4	16	2	6	5	10	13	7	0.5	112	112	0.02
16	JB16-4-070	4	0.7	26.5	4.5	6	16	2	6	5	10	15	7	0.5	200	200	0.02
20	JB20-5-080	5	0.8	33	5	6.5	21	4.5	7	7	13	19.5	8	0.5	1100	300	0.04
25	JB25-6-100	6	1	38	6	8	24	5	8	8	17	22.5	9	0.5	2500	500	0.07
32, 40	JB40-8-125	8	1.25	51	8.5	11	31	6	11	11	22	29	13	0.75	6000	1300	0.15
50, 63	JB63-10-150	10	1.5	62.5	10	13	41	7.5	14	13.5	27	35.5	15	1	11000	3100	0.29
80	JB80-16-200	16	2	80.5	16	20	50	9.5	19	16	32	47.5	18	1.25	18000	5000	0.56
100	JB100-20-250	20	2.5	101	21	26	59.5	11.5	24	20	41	59	24	2	28000	7900	1.04
125, 140	JB140-22-250	22	2.5	129	17	22	79	14	30	22	46	71.5	38	2.5	54000	15300	2.6
160	JB160-24-300	24	3	149	20	26	96	16	36	24	55	83	42	3	71000	20000	4.5

Floating Joint: Stainless Steel Type

JS Series

RoHS

Specifications

Operating pressure	Pneumatic cylinder: 1 MPa or less
	Hydraulic cylinder: 3.5 MPa or less
Mounting	Basic type

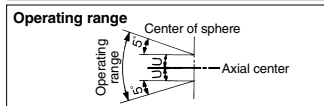

JS series

⚠ Precautions

Be sure to read this before handling the products. Refer to page 20 for safety instructions.

Mounting

⚠ Warning

- For the screw-in depth of the female threads, refer to the dimensions (page 1248).
- The dust cover may adhere to the stud. In this case, move the dust cover at the neck of the stud by the finger or twist the stud slightly left or right to break in the dust cover before use.
Additionally, when screwing the stud and socket or the case into a driven body, screw in such parts with the dust cover removed. When screwing in such parts without removing the dust cover, this may cause damage to the dust cover.
- To use a floating joint to connect the cylinder rod to a driven body, secure it in place by applying a torque that is appropriate for the thread size. Also, if there is a risk of loosening during operation, take measures to prevent loosening, such as using a locking pin or thread adhesive.
In the event that the connected portion becomes loose, the driven body might lose control or fall off, leading to equipment damage or injury to personnel.
- This product is not a rotary joint. So, the product cannot be used for rotational or rotation acting applications.
- Be sure to use the cushion mechanism of the cylinder or the buffer mechanism, such as the shock absorber so that any impact force is not applied to the floating joint when stopping a driven body. If there is no buffer mechanism, an excessive impact force is generated. As a result, the tensile compression force of the floating joint may exceed its maximum level.

Specifications

Model	Applicable bore size (mm) ⁽¹⁾	Applicable cylinder nominal thread size	Maximum operating tension and compression force (N)	Allowable eccentricity U (mm)	Operating pressure		Ambient temperature
					pneumatic cylinder	Hydraulic cylinder	
JS10-4-070	10	M4 x 0.7	80	0.5	1 MPa or less	-	-5 to 70°C
JS16-5-080	10, 16	M5 x 0.8	210	0.5			
JS20-8-125	20	M8 x 1.25	1100	0.5			
JS32-10-125	25, 32	M10 x 1.25	2500	0.5			
JS40-14-150	40	M14 x 1.5	6000	0.75			
JS63-18-150	50, 63	M18 x 1.5	11000	1			

Note 1) Think of applicable bore size as a guide. For details, confirm the rod end thread diameter of a cylinder to be used in the catalog.

Note 2) For 3.5 MPa hydraulic cylinders, operate within the maximum tension and compression force.

How to Order

J S 32 - 10-125

Stainless steel type Applicable bore size (mm) Nominal thread size Dust cover material

Symbol	Applicable bore size (mm)	Symbol	Applicable cylinder nominal thread size	Symbol	Material
10	10	4-070	M4 x 0.7	NIL	Fluororubber
16	10, 16	5-080	M5 x 0.8	S	Silicone rubber
20	20	8-125	M8 x 1.25		
32	25, 32	10-125	M10 x 1.25		
40	40	14-150	M14 x 1.5		
63	50, 63	18-150	M18 x 1.5		

Note)

80	80
100	100

Made to Order: Individual Specifications -X530
Note) For details, refer to page 1249.
For pneumatic cylinders

Stainless steel 304

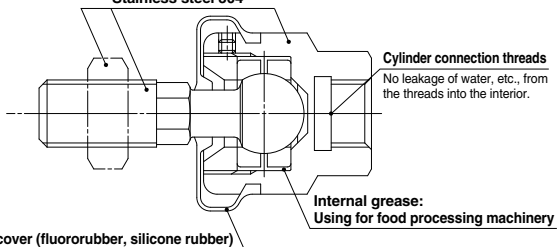

Dust cover (fluororubber, silicone rubber)

- The shape of the cover prevents residual liquid.
- Improved sealing

Maintenance

⚠ Warning

- Do not reuse if disassembled.
High strength adhesive is applied to the portion of the connection that is threaded to prevent it from loosening, and it must not be disassembled. If it is forcefully disassembled, it could lead to damage.

Design

⚠ Warning

- JS series has play in the axial direction. (Default: 0.06 mm or less)
When positioning the driven object, avoid the influence of play using a knock pin or external stopper.

Construction

ø10, ø16

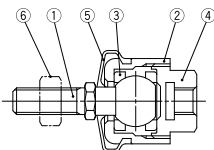

ø20 to ø63

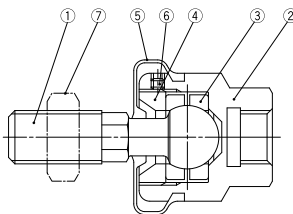

Component Parts

No.	Description	Material	Note
1	Stud	Stainless steel	
2	Case	Stainless steel	
3	Ring	Stainless steel	
4	Socket	Stainless steel	
5	Dust cover	Fluororubber/Silicon rubber	
6	Rod end nut	Stainless steel	

Component Parts

No.	Description	Material	Note
1	Stud	Stainless steel (Thread parts)	Electroless nickel plated
2	Case	Stainless steel	
3	Ring	Chromium molybdenum steel	Electroless nickel plated
4	Cap	Carbon steel	Electroless nickel plated
5	Dust cover	Fluororubber/Silicon rubber	
6	Set screw	Carbon steel	
7	Rod end nut	Stainless steel	

Replacement Parts

Dust cover

When the dust cover is damaged and deteriorated, order with the part number as shown below.

Model	Part no. for dust cover	
	Fluoro rubber	Silicon rubber
JS10	P21530511	P21530512
JS16	P21530521	P21530522
JS20	P2153151	P2153152
JS32	P2153251	P2153252
JS40	P2153351	P2153352
JS63	P2153451	P2153452

Rod end nunut

One rod end nut is supplied with the JS series. If additional nuts are needed, please order them using the part no. shown below.

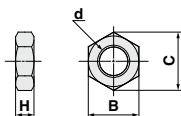

Model	Order no.	d: Thread nominal size	H	B	C
JS10-4-070	DA00127	M4x0.7	3.2	7	8.1
JS16-5-080	DA00128	M5x0.8	4	8	9.2
JS20-8-125	DA00036	M8x1.25	5	13	15
JS32-10-125	DA00006	M10x1.25	6	17	19.6
JS40-14-150	DA00186	M14x1.5	8	22	25.4
JS63-18-150	DA00188	M18x1.5	11	27	31.2

Dimensions

JS10, 16

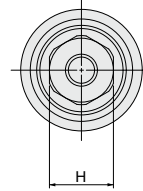
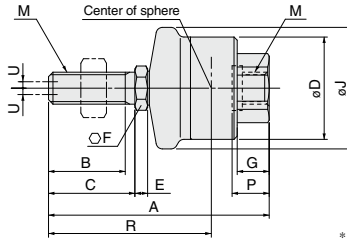

* Use the precision spanner for clock 4 mm in the case of mounting male thread of JS10.

JS20, 32, 40, 63

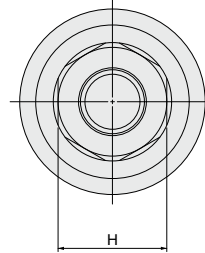
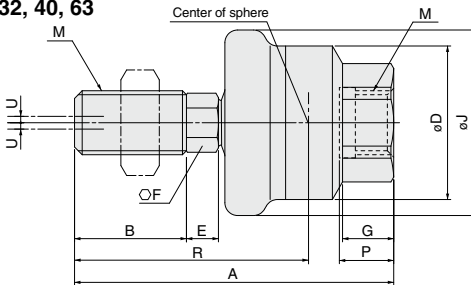

(mm)															
Model	M	A	B	C	D	E	F	G	H	J	Center of sphere R	Max. thread depth P	Allowable eccentricity U	Max. operating tension and compression force (N)	Weight (kg)
JS10-4-070	M4 x 0.7	26	8.5	9.5	12	1.5	4	4	7	14.4	17	4.7	0.5	80	0.01
JS16-5-080	M5 x 0.8	34.5	12	13.5	16	2	6	5	10	19	23	5.8	0.5	210	0.02
JS20-8-125	M8 x 1.25	43.9	15.5	—	21	4.5	7	7	13	24.8	29.9	7.3	0.5	1100	0.05
JS32-10-125	M10 x 1.25	49.5	17.5	—	24	5	8	8	17	29	33.5	8.5	0.5	2500	0.08
JS40-14-150	M14 x 1.5	60	18.5	—	31	5	11	11	22	38.4	38	11.6	0.75	6000	0.16
JS63-18-150	M18 x 1.5	74.5	23	—	41	7	14	13.5	27	49.2	47.5	14.3	1	11000	0.31

1 For Pneumatic Cylinders: For $\varnothing 80$, $\varnothing 100$

Symbol
-X530

Applicable to the floating joint and stainless steel type JS series and used for pneumatic cylinders with bore sizes of $\varnothing 80$ and $\varnothing 100$.
* This product is dedicated to the pneumatic cylinders.

Model/Specifications

Model	Applicable cylinder				Maximum operating tensile and compressive force N	Allowable eccentricity U (mm)	Ambient temperature (°C)	Weight (kg)
	Bore size (mm) <small>(Note)</small>	Nominal thread size	Dust cover material	Operating pressure				
JS80-22-150-X530	$\varnothing 80$	M22 x 1.5	Fluororubber	1 MPa or less	5000	1.25	- 5 to 70	0.58
JS80-22-150S-X530			Silicone rubber					
JS100-26-150-X530	$\varnothing 100$	M26 x 1.5	Fluororubber		7850	2		
JS100-26-150S-X530			Silicone rubber					

Note) Think of applicable bore size as a guide. For details, confirm the rod end thread diameter of a cylinder to be used in the catalog.

Dimensions

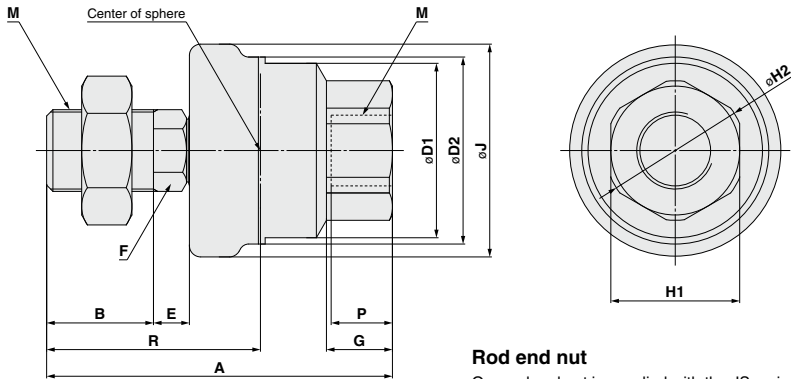

Rod end nut

One rod end nut is supplied with the JS series. If additional nuts are needed, please order them using the part no. shown below.

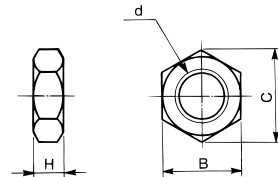

Model	Order no.	d: Nominal thread size	H	B	C
JS80-22-150(S)-X530	DA00243	M22 x 1.5	13	32	37
JS100-26-150(S)-X530	DA00189	M26 x 1.5	16	41	47.3

Dimensions

Model	M	A	B	D1	D2	E	F	G	H1	H2	J	Center of sphere R	Maximum thread depth P	Allowable eccentricity U	Maximum operating tensile and compressive force (N)	Weight (kg)
JS80-22-150(S)-X530	M22 x 1.5	89.5	28	46	50	9.9	19	16.8	32	34.7	57.2	56.5	14	1.25	5000	0.58
JS100-26-150(S)-X530	M26 x 1.5	110	34	55.5	59.5	11.4	24	21	41	44.4	66.2	68	19.5	2	7850	1.05