

Fluoropolymer Piping Equipment

LQ1/LQ3/LVN/LQHB/T□ Series

RoHS

Clean Wet Series

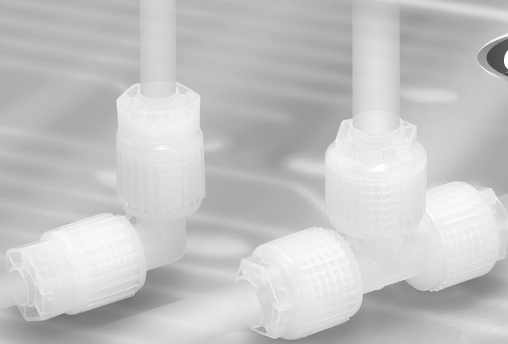

- LVC
- LVA
- LVH
- LVD
- LVQ
- LVP
- LVW
- LQ1
- LQ3
- LVN
- LQHB
- TL
- TIL
- TLM
- TILM
- TD
- TID
- TH
- TIH

Fluoropolymer Fittings Hyper Fittings
LQ1 Series

New PFA

Fluoropolymer Fittings Hyper Fittings/ Flare Type
LQ3 Series

New PFA

Needle Valve
LVN Series

New PFA

Bore Through Connector
LQHB Series

New PFA

Fluoropolymer Tubing
TL/TIL Series

Super PFA

Fluoropolymer Tubing
TLM/TILM Series

PFA

Soft Fluoropolymer Tubing
TD/TID Series

Modified PTFE

FEP Tubing (Fluoropolymer)
TH/TIH Series

FEP

Fluoropolymer Fittings Hyper Fittings

● Quadruple sealing construction

The quadruple sealing construction (PAT.) based on SMC's original idea results in highly reliable sealing characteristics with outstanding leakage prevention effect.

● Flow-through characteristics ● 200°C compatible

Excellent flow-through characteristics are achieved by minimizing liquid deposit.

● Locking

- Locking mechanism utilizes sealing lock by the nut.
- Trapezoidal thread allows application of high torque.
- 2 stage pressing by the tubing holder of the nut ensures secure tube holding.

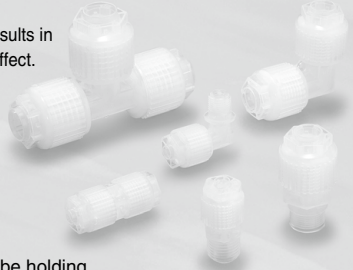

Basic

2 stage pressing construction ensures sealing and tubing locking to absorb differences in the tube outside diameter.

D side sealing

A seal is formed when the tubing is inserted, with its insert bushing, and its compression against the internal nut.

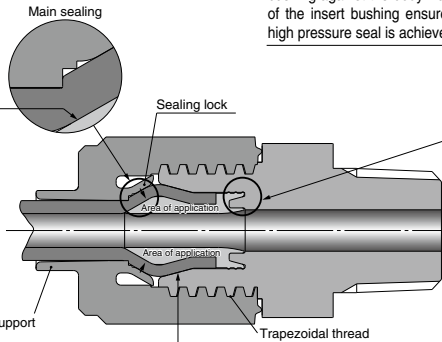

B side sealing

By tapering the face of the body, perfect sealing is achieved by the pressure of the bushing against the body wall (the protrusion of the insert bushing ensures that a secure high pressure seal is achieved).

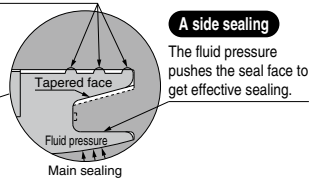

A side sealing

The fluid pressure pushes the seal face to get effective sealing.



C side sealing

Sealed by the pressure exerted on the tubing by the internal nut.

● Strong resistance to tube bending and deformation.

Able to withstand lateral loads with the tubing support.

● Easy tightening of nuts.

- No positioning guide is required, simply tighten up the tubing to the end of the fitting body.
- The trapezoidal thread prevents oblique nut insertion.

● Tubing sizes are interchangeable.

- The reducer method allows tubing size changes without replacing the body.
- Helps standardize fitting items resulting in less stock requirements.

Reducing type

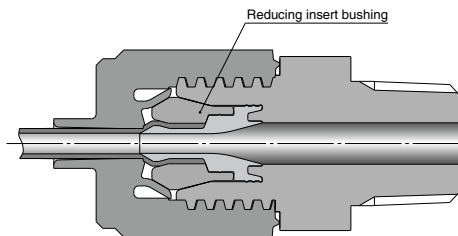

◎ LQ1 Series Addition of variations

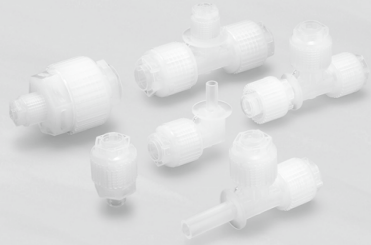

◎ Newly introduced shape

Union reducing 	Union elbow reducing 	Union tee reducing 	Panel mount union reducing
Space saving union elbow 	Space saving union tee 	Space saving union elbow reducing 	Space saving union tee reducing
Tubing extension union elbow 	Tubing extension union tee 	Tubing extension union elbow reducing 	Tubing extension union tee reducing

◎ Space-saving, piping work-saving

- Cut down on the fittings use by a variation upgrade on the different diameter connection(s).

Cut down on longitudinal dimension

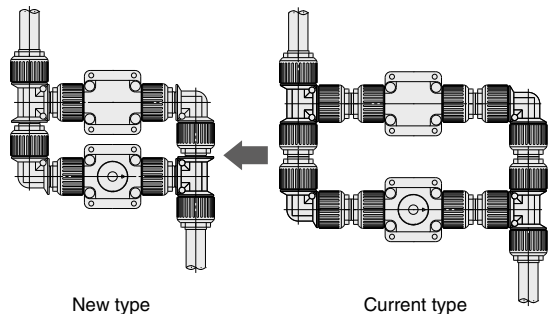

LVC

LVA

LVH

LVD

LVQ

LVP

LVW

LQ1

LQ3

LVN

LQHB

TL

TIL

TLM

TILM

TD

TID

TH

TIH

- ◎ Flare type collet construction
- ◎ Triple-seal construction
- ◎ Ease of installation
- ◎ Excellent flow-through characteristics
- ◎ Excellent heat resistance
- ◎ **200°C compatible**

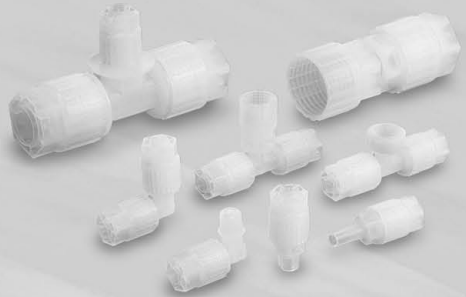

- Tubing retainer of the nut is made from a two-stage structure, enabling it to hold the tubing firmly.
- Fitting's seal surface to the tubing adopts a unique design to the area's pressure, resulting in improved sealing performance.

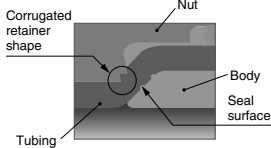

- To establish the tightening position, a gauge control is not required as the nut is designed to be tightened until the end surface of the fitting's main body.

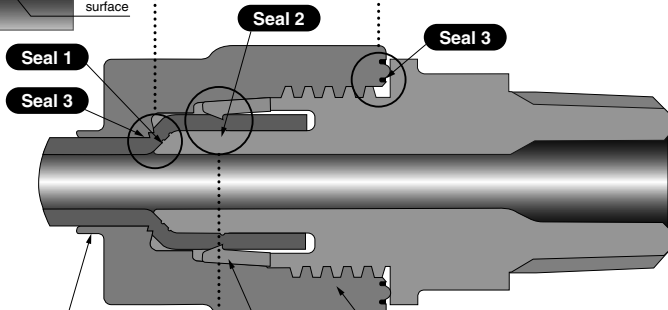
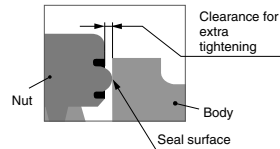

Tubing support

Providing additional strength against possible tube bending or deformation.

Collet

Trapezoidal thread

Prevents the nut from loosening at a high tightening torque, and from installing in a tilted position.
Heat resistant.

- Strengthening the prevention of the tubing release by means of the collet structure.
- Sealing performance is highly maintained in a circumferential seal surface having a unique shape even under thermal stress conditions.

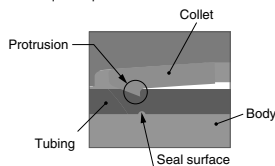

Fluoropolymer Needle Valve *LVN Series*

P.938

Integrated fitting construction

(Hyper fitting, LQ2 series is used.)

- Quadruple sealing method
- Nut locking mechanism
- High flexural strength
- Different tubing sizes can be selected.



● Fluid adjustment range 0 to 12 L/min

● Integrated fitting construction
Hyper fitting, LQ2 series is used.

● Triple seal construction

Triple seal construction

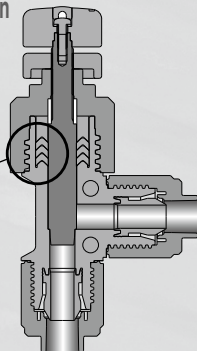

Fluoropolymer Bore Through Connector *LQHB Series*

P.941

● Freely choose tube positioning

Can be used in pressure feed of chemical liquids, etc., during the production process of semiconductors. Applicable to chemical liquids such as acid, alkali and deionized water.

As the tube runs through the fitting itself, a setting is available for any optional position.



Easy tightening of nuts

The trapezoidal thread prevents oblique nut insertion.

Nut

Material: New PFA
Maximum operating temperature
200°C

Taper thread

Thread type: R, NPT

Body

Material: New PFA

Locking

Trapezoidal thread allows application of high torque.

Collet

The tube is held securely in place by the tightening nut and collet.
Material: PTFE

Applications

Pressure feed of chemical liquids

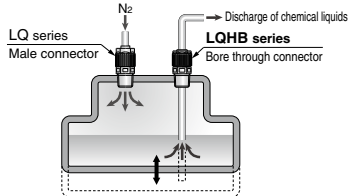

A changing of the tube position is available in accordance with the depth of the container.

Water trap

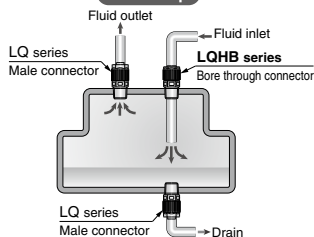

Fluid temperature control

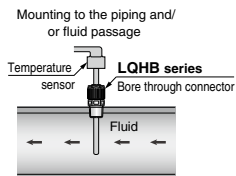

LVC
LVA
LVH
LVD
LVQ
LVP
LVW
LQ1
LQ3
LVN
LQHB
TL
TIL
TLM
TILM
TD
TID
TH
TIH

Fluoropolymer Tubing *TL/TIL Series*

P.948

Operating Temperature ^{Note)} Max. 260°C

Note) It varies depending on the conditions.

For details, refer to page 948.

Materials: Super PFA

14 Size Variations

- Metric Sizes: $\phi 4$ to $\phi 19$ [6 size]
- Inch Sizes: 1/8" to 1" [8 size]



Fluoropolymer Tubing (PFA) *TLM/TILM Series*

P.949

Operating Temperature ^{Note)} Max. 260°C

Note) It varies depending on the conditions.

For details, refer to pages 950 and 951.

Applications: Photovoltaic cell manufacturing, LCD manufacturing, HDD manufacturing, Medical, Food

Compatible with the Food Sanitation Law

- Compatible with the test conforming to Japan's the Food Sanitation Law based on the 370th notice given by the Ministry of Health and Welfare in 1959.
- Complies with FDA (Food and Drug Administration) §177-1550 dissolution test.

4 Color Variations

22 Size Variations

- Metric Sizes: $\phi 2$ to $\phi 25$ [13 size]
- Inch Sizes: 1/8" to 1 1/4" [9 size]



Soft Fluoropolymer Tubing *TD/TID Series*

From page 952

Flexibility: Improved by approx. 20%

* SMC comparison (Fluoropolymer tubing, TL/TIL series)

Applications: Food, Semi-conductor, Medical, Automobile and Machine tools fields

Compatible with the Food Sanitation Law

- Compatible with the test conforming to Japan's the Food Sanitation Law based on the 370th notice given by the Ministry of Health and Welfare in 1959.
- Complies with FDA (Food and Drug Administration) §177-1550 dissolution test.

Material: Modified PTFE

Operating Temperature ^{Note)} Max. 260°C

Note) It varies depending on the operating pressure.

Refer to the graph for maximum operating pressure (pages 952 and 953).

10 Size Variations

- Metric Sizes: $\phi 4$ to $\phi 12$ [5 size]
- Inch Sizes: 1/8" to 1/2" ($\phi 3.18$ to $\phi 12.7$) [5 size]

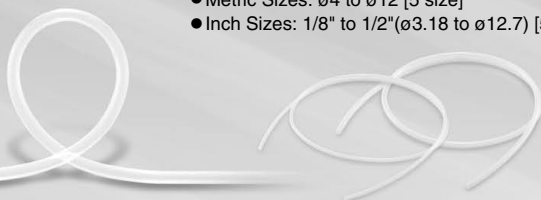

FEP Tubing (Fluoropolymer) **TH/TIH Series** From page **954**



Operating Temperature ^{Note)} **200°C**

Note) It varies depending on the operating pressure.
Refer to the graph for maximum operating pressure (pages 954 and 956).

Material: **FEP**

4 Color Variations: Translucent, Black, Red, Blue

19 Size Variations

- Metric Sizes: $\phi 4$ to $\phi 12$
- Inch Sizes: 1/8" to 3/4"

Applications: For general pneumatic piping, Food, Semi-conductor, Medical, Automobile fields

Compatible with the Food Sanitation Law

Compatible with the test conforming to the Food Sanitation Law based on the 370th notice given by the Ministry of Health and Welfare in 1959.

Fluoropolymer Tubing Variations

Series	TL/TIL	TLM/TILM	TD/TID	TH/TIH
Features	It is suitable for applications which require a highly smooth internal surface and small amount of elution of fluorine ions. * It has heat and chemical resistance equivalent to PFA.	The material consists of a good chemical resistant fluoropolymer. This also has good heat resistance, and it is suitable for a wide range of applications.	Flexibility improved by approx. 20% (Compared with SMC TL/TIL Series) Suitable for applications which require flexibility.	This has better resistance in chemical liquids environments.
Material	Super PFA	PFA	Modified PTFE	FEP
Chemical resistance	◎	◎	◎	○
Heat resistance	260°C	260°C	260°C	200°C
Flexibility	△	△	○	△
Ion elution	◎	○	○	○
Internal smoothness	○	△	○	◎
Fluid	Chemical liquids, Deionized water	Chemical liquids, Deionized water	Air, Water, Inert gas	
Tubing O.D.	Metric	$\phi 4$ to $\phi 19$	$\phi 2$ to $\phi 25$	$\phi 4$ to $\phi 12$
	Inch	1/8" to 1"	1/8" to 1 1/4"	1/8" to 1/2"
Color	Translucent	Translucent, Red, Blue, Black	Translucent	Translucent, Red, Blue, Black
Applicable fitting series	One-touch fittings	KQ2, KQG2, QQB2, KP, KP□	KQ2, KQG2, QQB2, KP, KP□	—
	Miniature fittings	M, MS (Hose nipple type)	M, MS (Hose nipple type)	M, MS (Hose nipple type)
	Insert fittings	KF, KFG2	KF, KFG2	KF, KFG2
	Fluoropolymer fittings	LQ series	LQ series	LQ series

◎: Very good ○: Good △: Moderate

The comparison table shown above was prepared based on a relative comparison taking the characteristics of each fluoropolymer tubing into consideration.

Related Products

Tube Cutter: TK-5



P.956-1





As this product is made of stainless steel it can be used inside clean rooms.
* However, this product is packaged regularly, not in double packaging.

- LVC
- LVA
- LVH
- LVD
- LVQ
- LVP
- LWV
- LQ1
- LQ3
- LVN
- LQHB
- TL
TIL
- TLM
TILM
- TD
TID
- TH
TIH

LQ1 Series

Fluoropolymer Fittings Hyper Fittings

LQ1 Series P.874

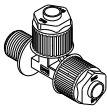
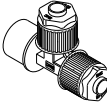
Series	Appearance	Class	Port size						Tubing O.D.															
									Metric size							Inch size								
			None	1/8"	1/4"	3/8"	1/2"	3/4"	1"	ø3	ø4	ø6	ø8	ø10	ø12	ø19	ø25	1/8"	3/16"	1/4"	3/8"	1/2"	3/4"	1"
Connector LQ1H	Male  P.877	1	-	○	-	-	-	-	○	○	-	-	-	-	-	○	-	-	-	-	-	-	-	-
		2	-	○	○	-	-	-	●	●	○	-	-	-	-	●	●	○	-	-	-	-	-	-
		3	-	○	○	○	-	-	●	●	●	●	○	-	-	●	-	●	○	-	-	-	-	-
		4	-	-	○	○	○	-	-	●	●	●	●	○	-	-	●	-	●	●	○	-	-	-
		5	-	-	○	○	○	○	-	-	●	-	○	●	○	-	-	●	○	●	○	-	-	-
		6	-	-	-	-	○	○	○	-	-	-	-	-	●	●	○	-	-	-	●	●	○	-
	Female  P.878	1	-	○	-	-	-	-	○	○	-	-	-	-	-	○	-	-	-	-	-	-	-	-
		2	-	○	○	-	-	-	●	●	○	-	-	-	-	●	●	○	-	-	-	-	-	-
		3	-	○	○	○	-	-	-	-	●	●	○	-	-	-	-	●	○	-	-	-	-	-
		4	-	○	○	○	○	-	-	-	-	●	●	●	○	-	-	-	○	●	○	-	-	-
		5	-	-	○	○	○	○	-	-	-	-	-	-	●	○	-	-	-	-	●	○	-	-
		6	-	-	-	-	-	○	○	-	-	-	-	-	-	●	○	-	-	-	-	-	-	●
Elbow LQ1L	Male  P.879	1	-	○	-	-	-	-	○	○	-	-	-	-	-	○	-	-	-	-	-	-	-	
		2	-	○	○	-	-	-	●	●	○	-	-	-	-	●	●	○	-	-	-	-	-	
		3	-	○	○	○	-	-	●	●	●	●	○	-	-	●	-	●	○	-	-	-	-	
		4	-	-	○	○	○	-	-	●	●	●	●	○	-	-	●	-	●	●	○	-	-	
		5	-	-	-	○	○	○	-	-	●	●	○	●	○	-	-	-	●	○	●	○	-	-
		6	-	-	-	○	-	○	○	-	-	-	-	-	●	●	○	-	-	-	-	●	●	○
	Female  P.880	1	-	○	-	-	-	-	○	○	-	-	-	-	-	○	-	-	-	-	-	-	-	
		2	-	○	○	-	-	-	●	●	○	-	-	-	-	●	●	○	-	-	-	-	-	
		3	-	○	○	○	-	-	●	●	●	○	-	-	-	●	-	●	○	-	-	-	-	
		4	-	○	○	○	○	-	-	-	-	●	○	-	-	-	-	-	●	○	-	-	-	
		5	-	-	-	○	○	○	-	-	-	-	-	-	●	○	-	-	-	-	●	○	-	-
		6	-	-	-	-	-	○	○	-	-	-	-	-	-	●	○	-	-	-	-	-	-	●
Run tee LQ1R	Male  P.881	1	-	○	-	-	-	-	○	○	-	-	-	-	-	○	-	-	-	-	-	-	-	
		2	-	○	○	-	-	-	●	●	○	-	-	-	-	●	●	○	-	-	-	-	-	
		3	-	○	○	○	-	-	-	-	●	●	○	-	-	-	-	-	●	○	-	-	-	
		4	-	○	○	○	-	-	-	-	-	●	○	-	-	-	-	-	-	●	○	-	-	
		5	-	-	○	○	○	○	-	-	-	-	-	-	●	○	-	-	-	-	●	○	-	-
		6	-	-	-	-	-	○	○	-	-	-	-	-	-	●	○	-	-	-	-	-	-	●
	Female  P.882	1	-	○	-	-	-	-	○	○	-	-	-	-	-	○	-	-	-	-	-	-	-	
		2	-	○	○	-	-	-	●	●	○	-	-	-	-	●	●	○	-	-	-	-	-	
		3	-	○	○	○	-	-	-	-	●	●	○	-	-	-	-	-	●	○	-	-	-	
		4	-	○	○	○	○	-	-	-	-	●	○	-	-	-	-	-	-	●	○	-	-	
		5	-	-	-	○	○	○	-	-	-	-	-	-	●	○	-	-	-	-	●	○	-	-
		6	-	-	-	-	-	○	○	-	-	-	-	-	-	●	○	-	-	-	-	-	-	●

(Note) ○Basic size ●With reducer

- LVC
- LVA
- LVH
- LVJ
- LVK
- LVL
- LVN
- LVQ
- LVP
- LVW
- LQ1**
- LQ3
- LVN
- LQHB
- TL
- TIL
- TLM
- TILM
- TD
- TID
- TH
- TIH

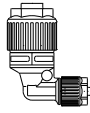
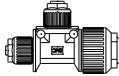
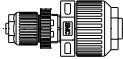
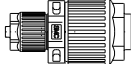
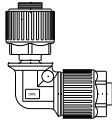
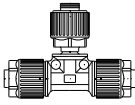
Series	Appearance	Class	Tubing O.D.														
			Metric size							Inch size							
			ø3	ø4	ø6	ø8	ø10	ø12	ø19	ø25	1/8"	3/16"	1/4"	3/8"	1/2"	3/4"	1"
Union elbow reducing LQ1E-R	 P.889	2	●	●	○	-	-	-	-	-	●	●	○	-	-	-	-
		3	-	-	●	●	○	-	-	-	-	-	●	○	-	-	-
		4	●	-	●	●	●	○	-	-	●	●	●	●	○	-	-
		5	-	●	●	●	●	●	○	-	-	●	●	●	●	○	-
		6	-	-	●	●	●	●	●	○	-	●	●	●	●	●	○
		Union tee reducing LQ1T-R	 P.891	2	●	●	○	-	-	-	-	-	●	●	○	-	-
3	●			-	●	●	○	-	-	-	-	-	●	○	-	-	-
4	●			-	●	●	●	○	-	-	●	-	●	●	○	-	-
5	●			●	●	●	●	●	○	-	●	-	●	●	●	○	-
6	-			-	●	●	●	●	●	○	-	-	●	●	●	●	○
Panel mount union reducing LQ1P-R	 P.896			2	●	●	○	-	-	-	-	-	●	●	○	-	-
		3	-	-	●	●	○	-	-	-	-	-	●	○	-	-	-
		4	-	-	●	-	●	○	-	-	-	-	●	●	○	-	-
		5	-	-	-	-	●	●	○	-	-	-	-	●	●	○	-
		6	-	-	-	-	-	-	●	○	-	-	-	-	-	●	○
		Union reducing LQ1U-R	 P.897	2	●	●	○	-	-	-	-	-	●	●	○	-	-
3	●			●	●	●	○	-	-	-	●	●	●	○	-	-	-
4	●			●	●	●	●	○	-	-	●	●	●	●	○	-	-
5	●			●	●	●	●	●	○	-	●	●	●	●	●	○	-
6	-			-	●	-	●	●	●	○	-	-	●	●	●	●	○
Space saving union elbow LQ1E-SS	 P.898			2	-	-	○	-	-	-	-	-	-	-	○	-	-
		3	-	-	-	●	○	-	-	-	-	-	-	○	-	-	-
		4	-	-	-	-	-	○	-	-	-	-	-	-	○	-	-
		5	-	-	-	-	-	-	○	-	-	-	-	-	-	○	-
		6	-	-	-	-	-	-	-	○	-	-	-	-	-	-	○
		Space saving union tee LQ1T-S	 P.900	2	-	-	○	-	-	-	-	-	-	-	○	-	-
3	-			-	-	●	○	-	-	-	-	-	-	○	-	-	-
4	-			-	-	-	-	○	-	-	-	-	-	-	○	-	-
5	-			-	-	-	-	-	○	-	-	-	-	-	-	○	-
6	-			-	-	-	-	-	-	○	-	-	-	-	-	-	○



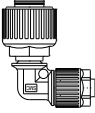
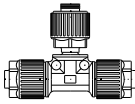
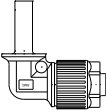
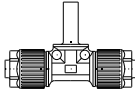
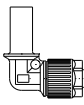
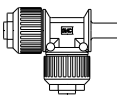

Note) ○Basic size ●With reducer

- LVC
- LVA
- LVH
- LVD
- LVQ
- LVP
- LVW
- LQ1**
- LQ3
- LVN
- LQHB
- TL
- TIL
- TLM
- TILM
- TD
- TID
- TH
- TIH

LQ1 Series

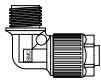
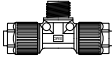
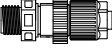
Series	Appearance	Class	Tubing O.D.											Can be connected body class										
			Metric size						Inch size					2	3	4	5	6						
			ø3	ø4	ø6	ø8	ø10	ø12	ø19	ø25	1/8"	3/16"	1/4"						3/8"	1/2"	3/4"	1"		
Space saving union elbow reducing LQ1E-SS-R		P.899	2	-	-	○	-	-	-	-	-	-	○	-	-	-	-	○	○	-	-			
			3	-	-	-	○	○	-	-	-	-	-	○	-	-	-	-	○	○	-	-		
			4	-	-	-	-	-	○	-	-	-	-	-	○	-	-	-	-	○	○	-	-	
			5	-	-	-	-	-	-	-	-	-	-	-	-	-	-	-	-	-	-	-	-	
			6	-	-	-	-	-	-	-	○	-	-	-	-	-	-	-	○	-	-	○	-	
			Space saving union tee reducing LQ1T-S-R		P.901	2	-	-	○	-	-	-	-	-	-	-	-	-	-	-	○	-	-	-
3	-	-				-	●	-	-	-	-	-	●	○	-	-	-	-	-	○	-	-	-	
4	-	-				-	-	-	○	-	-	-	-	●	○	-	-	-	-	-	○	-	○	-
5	-	-				○	-	-	●	○	-	-	-	●	●	○	-	-	-	-	○	○	○	○
6	-	-				-	-	-	●	○	-	-	-	-	-	●	○	-	-	-	○	○	○	○
Tubing extension union elbow LQ1E-T		P.903				2	-	-	○	-	-	-	-	-	-	○	-	-	-	-	-	-	-	-
			3	-	-	-	●	○	-	-	-	-	-	○	-	-	-	-	-	-	-	-	-	
			4	-	-	-	-	-	○	-	-	-	-	-	○	-	-	-	-	-	-	-	-	
			5	-	-	-	-	-	-	○	-	-	-	-	-	○	-	-	-	-	-	-	-	
			6	-	-	-	-	-	-	-	-	○	-	-	-	-	-	-	-	-	-	-	-	-
			Tubing extension union tee LQ1T-T		P.904	2	-	-	○	-	-	-	-	-	-	○	-	-	-	-	-	-	-	-
3	-	-				-	●	○	-	-	-	-	-	○	-	-	-	-	-	-	-	-	-	
4	-	-				-	-	-	○	-	-	-	-	-	○	-	-	-	-	-	-	-	-	
5	-	-				-	-	-	-	○	-	-	-	-	-	○	-	-	-	-	-	-	-	
6	-	-				-	-	-	-	-	-	○	-	-	-	-	-	-	-	-	-	-	-	-
Tubing extension union elbow reducing LQ1E-T-R		P.905				2	-	-	○	○	○	-	-	-	-	○	○	-	-	-	-	○	○	-
			3	-	-	○	○	○	○	-	-	-	-	○	○	○	-	-	-	○	○	-	-	
			4	-	-	○	○	○	○	○	-	-	-	-	○	○	○	○	-	-	○	○	-	-
			5	-	-	-	-	-	-	-	○	-	-	-	-	-	-	-	-	-	-	-	-	
			6	-	-	-	-	-	-	-	-	○	-	-	-	-	-	-	-	-	-	-	-	-
			Tubing extension union tee reducing LQ1T-T-R		P.906	2	-	-	-	-	-	-	-	-	-	○	-	-	-	-	-	-	-	-
3	-	-				-	-	-	-	-	-	-	-	○	-	-	-	-	-	-	-	-	-	
4	-	-				-	-	-	○	-	-	-	-	-	●	○	-	-	-	-	○	○	-	-
5	-	-				-	-	-	-	○	-	-	-	-	-	○	○	○	-	-	-	○	○	-
6	-	-				-	-	-	-	-	-	○	-	-	-	-	○	○	○	-	-	-	○	○

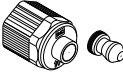
Note) ○Basic size ●With reducer









Series	Appearance	Class	Tubing O.D.													
			Metric size							Inch size						
			ø3	ø4	ø6	ø8	ø10	ø12	ø19	ø25	1/8"	3/16"	1/4"	3/8"	1/2"	3/4"
Space saving type union elbow LQ1E-SN  P.908	1	○	○	-	-	-	-	-	-	○	-	-	-	-	-	-
	2	-	●	○	-	-	-	-	-	●	●	○	-	-	-	-
	3	-	-	●	●	○	-	-	-	-	-	●	○	-	-	-
	4	-	-	-	-	●	○	-	-	-	-	-	●	○	-	-
	5	-	-	-	-	-	●	○	-	-	-	-	-	●	○	-
	6	-	-	-	-	-	-	●	○	-	-	-	-	-	●	○
Space saving type union tee LQ1T-SN  P.908	1	○	○	-	-	-	-	-	-	○	-	-	-	-	-	-
	2	-	●	○	-	-	-	-	-	●	●	○	-	-	-	-
	3	-	-	●	●	○	-	-	-	-	-	●	○	-	-	-
	4	-	-	-	-	●	○	-	-	-	-	-	●	○	-	-
	5	-	-	-	-	-	●	○	-	-	-	-	-	●	○	-
	6	-	-	-	-	-	-	●	○	-	-	-	-	-	●	○
Space saving type panel mount union LQ1P-SN  P.908	1	○	○	-	-	-	-	-	-	○	-	-	-	-	-	-
	2	-	●	○	-	-	-	-	-	●	●	○	-	-	-	-
	3	-	-	●	●	○	-	-	-	-	-	●	○	-	-	-
	4	-	-	-	-	●	○	-	-	-	-	-	●	○	-	-
	5	-	-	-	-	-	●	○	-	-	-	-	-	●	○	-
	6	-	-	-	-	-	-	●	○	-	-	-	-	-	●	○
Space saving type union LQ1U-SN  P.908	1	○	○	-	-	-	-	-	-	○	-	-	-	-	-	-
	2	-	●	○	-	-	-	-	-	●	●	○	-	-	-	-
	3	-	-	●	●	○	-	-	-	-	-	●	○	-	-	-
	4	-	-	-	-	●	○	-	-	-	-	-	●	○	-	-
	5	-	-	-	-	-	●	○	-	-	-	-	-	●	○	-
	6	-	-	-	-	-	-	●	○	-	-	-	-	-	●	○
Panel mounting nut LQNP  P.908	1	-	-	-	-	-	-	-	-	-	-	-	-	-	-	-
	2	-	-	-	-	-	-	-	-	-	-	-	-	-	-	-
	3	-	-	-	-	-	-	-	-	-	-	-	-	-	-	-
	4	-	-	-	-	-	-	-	-	-	-	-	-	-	-	-
	5	-	-	-	-	-	-	-	-	-	-	-	-	-	-	-
	6	-	-	-	-	-	-	-	-	-	-	-	-	-	-	-
Nut insert bush LQ1-U B N  P.909	1	○	○	-	-	-	-	-	-	○	-	-	-	-	-	-
	2	○	○	○	-	-	-	-	-	○	○	○	-	-	-	-
	3	-	-	○	○	○	-	-	-	-	-	○	○	-	-	-
	4	-	-	-	-	○	○	-	-	-	-	-	○	○	-	-
	5	-	-	-	-	-	○	○	-	-	-	-	-	○	○	-
	6	-	-	-	-	-	-	○	○	-	-	-	-	-	○	○
Blanking plug LQ-P  P.909	1	○	○	-	-	-	-	-	-	○	-	-	-	-	-	-
	2	●	●	○	-	-	-	-	-	●	●	○	-	-	-	-
	3	-	●	●	●	○	-	-	-	-	-	●	○	-	-	-
	4	-	-	-	-	●	○	-	-	-	-	-	●	○	-	-
	5	-	-	-	-	-	●	○	-	-	-	-	-	●	○	-
	6	-	-	-	-	-	-	●	○	-	-	-	-	-	●	○
Tubing plug LQ1-CP  P.909	1	○	○	-	-	-	-	-	-	○	-	-	-	-	-	-
	2	-	-	○	-	-	-	-	-	-	-	○	-	-	-	-
	3	-	-	-	○	○	-	-	-	-	-	-	○	-	-	-
	4	-	-	-	-	-	○	-	-	-	-	-	-	○	-	-
	5	-	-	-	-	-	-	○	-	-	-	-	-	-	○	-
	6	-	-	-	-	-	-	-	○	-	-	-	-	-	-	○

- LVC
- LVA
- LVH
- LVD
- LVQ
- LVP
- LVW
- LQ1**
- LQ3
- LVN
- LQHB
- TL
- TIL
- TLM
- TILM
- TD
- TID
- TH
- TIH

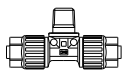
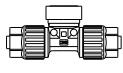

Note) ○Basic size ●With reducer

LQ3 Series

LQ3 Series P.912



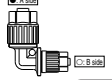
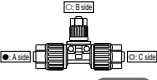

Series	Appearance	Class	Port size								Tubing O.D.															
											Metric size					Inch size										
			None	1/8"	1/4"	3/8"	1/2"	3/4"	1"	1 1/4"	ø3	ø4	ø6	ø8	ø10	ø12	ø19	ø25	1/8"	1/4"	3/8"	1/2"	3/4"	1"	1 1/4"	
Connector LQ3H	Male	 P.915	1	-	●	-	-	-	-	-	●	●	-	-	-	-	-	●	-	-	-	-	-	-	-	
			2	-	●	●	-	-	-	-	-	-	●	-	-	-	-	-	-	●	-	-	-	-	-	-
			3	-	●	●	●	●	-	-	-	-	-	●	●	-	-	-	-	-	●	-	-	-	-	-
			4	-	-	-	●	●	●	-	-	-	-	-	-	●	-	-	-	-	-	●	-	-	-	-
			5	-	-	-	●	●	●	-	-	-	-	-	-	-	●	-	-	-	-	-	●	-	-	-
			6	-	-	-	●	●	●	-	-	-	-	-	-	-	-	●	-	-	-	-	-	●	-	-
	Female	 P.916	1	-	●	-	-	-	-	-	-	●	●	-	-	-	-	-	●	-	-	-	-	-	-	
			2	-	●	●	-	-	-	-	-	-	●	-	-	-	-	-	-	-	●	-	-	-	-	-
			3	-	●	●	●	●	-	-	-	-	-	●	●	-	-	-	-	-	-	●	-	-	-	-
			4	-	-	-	●	●	●	-	-	-	-	-	-	●	-	-	-	-	-	-	●	-	-	-
			5	-	-	-	●	●	●	-	-	-	-	-	-	-	●	-	-	-	-	-	-	●	-	-
			6	-	-	-	●	●	●	-	-	-	-	-	-	-	-	●	-	-	-	-	-	-	●	-
Elbow LQ3L	Male	 P.917	1	-	●	-	-	-	-	-	●	●	-	-	-	-	-	-	●	-	-	-	-	-		
			2	-	●	●	-	-	-	-	-	-	●	-	-	-	-	-	-	-	●	-	-	-	-	
			3	-	●	●	●	●	-	-	-	-	-	●	●	-	-	-	-	-	-	●	-	-	-	-
			4	-	-	-	●	●	●	-	-	-	-	-	-	●	-	-	-	-	-	-	●	-	-	-
			5	-	-	-	●	●	●	-	-	-	-	-	-	-	●	-	-	-	-	-	-	●	-	-
			6	-	-	-	●	●	●	-	-	-	-	-	-	-	-	●	-	-	-	-	-	●	-	-
	Female	 P.918	1	-	●	-	-	-	-	-	-	●	●	-	-	-	-	-	-	●	-	-	-	-	-	
			2	-	●	●	-	-	-	-	-	-	●	-	-	-	-	-	-	-	-	●	-	-	-	-
			3	-	●	●	●	●	-	-	-	-	-	●	●	-	-	-	-	-	-	-	●	-	-	-
			4	-	-	-	●	●	●	-	-	-	-	-	-	●	-	-	-	-	-	-	-	●	-	-
			5	-	-	-	●	●	●	-	-	-	-	-	-	-	●	-	-	-	-	-	-	-	●	-
			6	-	-	-	●	●	●	-	-	-	-	-	-	-	-	●	-	-	-	-	-	-	●	-
Branch tee LQ3B	Male	 P.919	1	-	●	-	-	-	-	-	●	●	-	-	-	-	-	-	●	-	-	-	-	-		
			2	-	●	●	-	-	-	-	-	-	●	-	-	-	-	-	-	-	●	-	-	-	-	
			3	-	●	●	●	●	-	-	-	-	-	●	●	-	-	-	-	-	-	●	-	-	-	-
			4	-	-	-	●	●	●	-	-	-	-	-	-	●	-	-	-	-	-	-	●	-	-	-
			5	-	-	-	●	●	●	-	-	-	-	-	-	-	●	-	-	-	-	-	-	●	-	-
			6	-	-	-	●	●	●	-	-	-	-	-	-	-	-	●	-	-	-	-	-	-	●	-
	Female	 P.920	1	-	●	-	-	-	-	-	-	●	●	-	-	-	-	-	-	●	-	-	-	-	-	
			2	-	●	●	-	-	-	-	-	-	●	-	-	-	-	-	-	-	-	●	-	-	-	-
			3	-	●	●	●	●	-	-	-	-	-	●	●	-	-	-	-	-	-	-	●	-	-	-
			4	-	-	-	●	●	●	-	-	-	-	-	-	●	-	-	-	-	-	-	-	●	-	-
			5	-	-	-	●	●	●	-	-	-	-	-	-	-	●	-	-	-	-	-	-	-	●	-
			6	-	-	-	●	●	●	-	-	-	-	-	-	-	-	●	-	-	-	-	-	-	-	●
Run tee LQ3R	Male	 P.921	1	-	●	-	-	-	-	-	●	●	-	-	-	-	-	-	●	-	-	-	-	-		
			2	-	●	●	-	-	-	-	-	-	●	-	-	-	-	-	-	-	-	●	-	-	-	-
			3	-	●	●	●	●	-	-	-	-	-	●	●	-	-	-	-	-	-	-	●	-	-	-
			4	-	-	-	●	●	●	-	-	-	-	-	-	●	-	-	-	-	-	-	-	●	-	-
			5	-	-	-	●	●	●	-	-	-	-	-	-	-	●	-	-	-	-	-	-	-	●	-
			6	-	-	-	●	●	●	-	-	-	-	-	-	-	-	●	-	-	-	-	-	-	-	●
	Female	 P.922	1	-	●	-	-	-	-	-	-	●	●	-	-	-	-	-	-	●	-	-	-	-	-	
			2	-	●	●	-	-	-	-	-	-	●	-	-	-	-	-	-	-	-	●	-	-	-	-
			3	-	●	●	●	●	-	-	-	-	-	●	●	-	-	-	-	-	-	-	●	-	-	-
			4	-	-	-	●	●	●	-	-	-	-	-	-	●	-	-	-	-	-	-	-	●	-	-
			5	-	-	-	●	●	●	-	-	-	-	-	-	-	●	-	-	-	-	-	-	-	●	-
			6	-	-	-	●	●	●	-	-	-	-	-	-	-	-	●	-	-	-	-	-	-	-	●
Union elbow LQ3E	 P.923	1	●	-	-	-	-	-	-	●	●	-	-	-	-	-	-	●	-	-	-	-	-	-		
		2	●	-	-	-	-	-	-	-	●	-	-	-	-	-	-	-	-	●	-	-	-	-	-	
		3	●	-	-	-	-	-	-	-	-	●	●	-	-	-	-	-	-	-	●	-	-	-	-	
		4	●	-	-	-	-	-	-	-	-	-	-	●	-	-	-	-	-	-	-	●	-	-	-	
		5	●	-	-	-	-	-	-	-	-	-	-	-	●	-	-	-	-	-	-	-	●	-	-	
		6	●	-	-	-	-	-	-	-	-	-	-	-	-	●	-	-	-	-	-	-	-	●	-	
		7	●	-	-	-	-	-	-	-	-	-	-	-	-	-	●	-	-	-	-	-	-	-	●	
Union tee LQ3T	 P.923	1	●	-	-	-	-	-	-	●	●	-	-	-	-	-	-	●	-	-	-	-	-	-		
		2	●	-	-	-	-	-	-	-	●	-	-	-	-	-	-	-	-	●	-	-	-	-	-	
		3	●	-	-	-	-	-	-	-	-	●	●	-	-	-	-	-	-	-	●	-	-	-	-	
		4	●	-	-	-	-	-	-	-	-	-	-	●	-	-	-	-	-	-	-	●	-	-	-	
		5	●	-	-	-	-	-	-	-	-	-	-	-	●	-	-	-	-	-	-	-	●	-	-	
		6	●	-	-	-	-	-	-	-	-	-	-	-	-	-	●	-	-	-	-	-	-	-	●	

Fluoropolymer Fittings Hyper Fittings / Flare Type

Series	Appearance	Class	Port size											Tubing O.D.											
														Metric size						Inch size					
			None	1/8"	1/4"	3/8"	1/2"	3/4"	1"	1 1/4"	ø3	ø4	ø6	ø8	ø10	ø12	ø19	ø25	1/8"	1/4"	3/8"	1/2"	3/4"	1"	1 1/4"
Panel mount union LQ3P	 P.924	1	●	-	-	-	-	-	-	●	●	-	-	-	-	-	-	●	-	-	-	-	-	-	
		2	●	-	-	-	-	-	-	-	-	●	-	-	-	-	-	-	●	-	-	-	-	-	-
		3	●	-	-	-	-	-	-	-	-	-	●	●	-	-	-	-	-	●	-	-	-	-	-
		4	●	-	-	-	-	-	-	-	-	-	-	-	●	-	-	-	-	-	●	-	-	-	-
		5	●	-	-	-	-	-	-	-	-	-	-	-	-	-	●	-	-	-	-	●	-	-	-
		6	●	-	-	-	-	-	-	-	-	-	-	-	-	-	-	●	-	-	-	-	-	●	-
Union LQ3U	 P.924	1	●	-	-	-	-	-	-	●	●	-	-	-	-	-	-	●	-	-	-	-	-	-	
		2	●	-	-	-	-	-	-	-	-	●	-	-	-	-	-	-	●	-	-	-	-	-	-
		3	●	-	-	-	-	-	-	-	-	-	●	●	-	-	-	-	-	●	-	-	-	-	-
		4	●	-	-	-	-	-	-	-	-	-	-	-	●	-	-	-	-	-	●	-	-	-	-
		5	●	-	-	-	-	-	-	-	-	-	-	-	-	-	●	-	-	-	-	●	-	-	-
		6	●	-	-	-	-	-	-	-	-	-	-	-	-	-	-	●	-	-	-	-	-	●	-
		7	-	-	-	-	-	-	-	-	-	-	-	-	-	-	-	-	-	-	-	-	-	-	●

Series	Appearance	Class	Port size											Tubing O.D.											
														Metric size						Inch size					
			None	1/8"	1/4"	3/8"	1/2"	3/4"	1"	1 1/4"	ø3	ø4	ø6	ø8	ø10	ø12	ø19	ø25	1/8"	1/4"	3/8"	1/2"	3/4"	1"	1 1/4"
Union reducing LQ3U-R	 P.925	1	○	●	-	-	-	-	-	-	-	-	-	-	-	-	-	-	-	-	-	-	-	-	
		2	○	○	●	-	-	-	-	-	-	-	-	-	-	-	-	○	●	-	-	-	-	-	-
		3	-	○	○	●/○	●	-	-	-	-	-	-	-	-	-	-	-	○	○	●	-	-	-	-
		4	-	-	-	○	○	-	-	-	-	-	-	-	-	-	-	-	○	○	○	●	-	-	-
		5	-	-	-	-	-	-	-	-	-	-	-	-	-	-	-	-	○	○	○	○	●	-	-
		6	-	-	-	-	-	-	-	-	-	-	-	-	-	-	-	-	-	-	-	○	○	●	-
		7	-	-	-	-	-	-	-	-	-	-	-	-	-	-	-	-	-	-	-	-	○	○	●
Union elbow reducing LQ3E-R	 P.926	1	○	●	-	-	-	-	-	-	-	-	-	-	-	-	-	-	-	-	-	-	-	-	
		2	○	○	●	-	-	-	-	-	-	-	-	-	-	-	-	○	●	-	-	-	-	-	-
		3	-	○	○	●/○	○	-	-	-	-	-	-	-	-	-	-	-	○	○	○	●	-	-	-
		4	-	-	-	○	○	-	-	-	-	-	-	-	-	-	-	-	○	○	○	○	●	-	-
		5	-	-	-	-	-	-	-	-	-	-	-	-	-	-	-	-	○	○	○	○	○	●	-
		6	-	-	-	-	-	-	-	-	-	-	-	-	-	-	-	-	-	-	-	○	○	●	-
Union tee reducing LQ3T-R	 P.927	1	○/○	●/○/○	-	-	-	-	-	-	-	-	-	-	-	-	-	-	-	-	-	-	-	-	
		2	○/○	○/○	●/○/○	-	-	-	-	-	-	-	-	-	-	-	-	○/○	●/○/○	-	-	-	-	-	-
		3	-	-	○/○	●/○/○	○/○/○	-	-	-	-	-	-	-	-	-	-	○/○	○/○/○	○/○/○	-	-	-	-	-
		4	-	-	-	-	○/○	○/○/○	-	-	-	-	-	-	-	-	-	-	○/○	○/○/○	○/○/○	○/○/○	-	-	-
		5	-	-	-	-	-	-	-	-	-	-	-	-	-	-	-	-	○/○	○/○/○	○/○/○	○/○/○	○/○/○	-	-
		6	-	-	-	-	-	-	-	-	-	-	-	-	-	-	-	-	○/○	○/○/○	○/○/○	○/○/○	○/○/○	○/○/○	-









(Note) ● : A side tubing O.D. ○ : B side tubing O.D. ○/○ : C side tubing O.D.

Series	Appearance	Class	Port size											Tubing O.D.											
														Metric size						Inch size					
			None	1/8"	1/4"	3/8"	1/2"	3/4"	1"	1 1/4"	ø3	ø4	ø6	ø8	ø10	ø12	ø19	ø25	1/8"	1/4"	3/8"	1/2"	3/4"	1"	1 1/4"
Space saving union elbow LQ3E-S	 P.929	2	-	-	●	-	-	-	-	-	-	-	-	-	-	-	-	-	●	-	-	-	-	-	
		3	-	-	-	●	●	-	-	-	-	-	-	-	-	-	-	-	-	●	-	-	-	-	-
		4	-	-	-	-	-	-	-	-	-	-	-	-	-	-	-	-	-	-	●	-	-	-	-
		5	-	-	-	-	-	-	-	-	-	-	-	-	-	-	-	-	-	-	-	●	-	-	-
		6	-	-	-	-	-	-	-	-	-	-	-	-	-	-	-	-	-	-	-	-	●	-	-
		7	-	-	-	-	-	-	-	-	-	-	-	-	-	-	-	-	-	-	-	-	-	●	-
		Space saving branch tee LQ3T-SB	 P.930	2	-	-	●	-	-	-	-	-	-	-	-	-	-	-	-	-	-	●	-	-	-
3	-			-	-	●	●	-	-	-	-	-	-	-	-	-	-	-	-	-	●	-	-	-	-
4	-			-	-	-	-	-	-	-	-	-	-	-	-	-	-	-	-	-	-	●	-	-	-
5	-			-	-	-	-	-	-	-	-	-	-	-	-	-	-	-	-	-	-	-	●	-	-
6	-			-	-	-	-	-	-	-	-	-	-	-	-	-	-	-	-	-	-	-	-	●	-
7	-			-	-	-	-	-	-	-	-	-	-	-	-	-	-	-	-	-	-	-	-	-	●
Space saving run tee LQ3T-SR	 P.931	2	-	-	●	-	-	-	-	-	-	-	-	-	-	-	-	-	-	●	-	-	-	-	
		3	-	-	-	●	●	-	-	-	-	-	-	-	-	-	-	-	-	-	-	●	-	-	-
		4	-	-	-	-	-	-	-	-	-	-	-	-	-	-	-	-	-	-	-	-	●	-	-
		5	-	-	-	-	-	-	-	-	-	-	-	-	-	-	-	-	-	-	-	-	-	●	-
		6	-	-	-	-	-	-	-	-	-	-	-	-	-	-	-	-	-	-	-	-	-	-	●
		7	-	-	-	-	-	-	-	-	-	-	-	-	-	-	-	-	-	-	-	-	-	-	●
Tubing extension straight connector LQ3H-T	 P.932	2	-	-	●	-	-	-	-	-	-	-	-	-	-	-	-	-	-	●	-	-	-	-	
		3	-	-	-	●	●	-	-	-	-	-	-	-	-	-	-	-	-	-	-	●	-	-	-
		4	-	-	-	-	-	-	-	-	-	-	-	-	-	-	-	-	-	-	-	-	●	-	-
		5	-	-	-	-	-	-	-	-	-	-	-	-	-	-	-	-	-	-	-	-	-	●	-
		6	-	-	-	-	-	-	-	-	-	-	-	-	-	-	-	-	-	-	-	-	-	-	●
		7	-	-	-	-	-	-	-	-	-	-	-	-	-	-	-	-	-	-	-	-	-	-	●

LVC
LVA
LVH
LVD
LVQ
LVP
LVW
LQ1
LQ3
LVN
LQHB
TL
TIL
TLM
TILM
TD
TID
TH
TIH

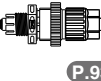
LQ3 Series

Fluoropolymer Fittings Hyper Fittings / Flare Type

Series	Appearance	Class	Tubing O.D.														
			Metric size							Inch size							
			ø3	ø4	ø6	ø8	ø10	ø12	ø19	ø25	1/8"	1/4"	3/8"	1/2"	3/4"	1"	1 1/4"
Straight adapter LQ3A  P.933	2	-	-	●	-	-	-	-	-	-	-	●	-	-	-	-	
	3	-	-	-	●	●	-	-	-	-	-	-	●	-	-	-	
	4	-	-	-	-	-	●	-	-	-	-	-	-	●	-	-	
	5	-	-	-	-	-	-	●	-	-	-	-	-	-	●	-	
	6	-	-	-	-	-	-	-	●	-	-	-	-	-	-	●	
	7	-	-	-	-	-	-	-	-	●	-	-	-	-	-	-	●
	Union flange LQ3F  P.935	2	-	-	●	-	-	-	-	-	-	●	-	-	-	-	-
3		-	-	-	-	-	-	-	-	-	-	-	-	-	-	-	
4		-	-	-	-	-	●	-	-	-	-	-	-	●	-	-	
5		-	-	-	-	-	-	●	-	-	-	-	-	-	●	-	
6		-	-	-	-	-	-	-	●	-	-	-	-	-	-	●	-
Space saving type union elbow LQ3E-SN  P.936		2	-	-	●	-	-	-	-	-	-	●	-	-	-	-	-
	3	-	-	-	●	●	-	-	-	-	-	●	-	-	-	-	
	4	-	-	-	-	-	●	-	-	-	-	-	●	-	-	-	
	5	-	-	-	-	-	-	●	-	-	-	-	-	●	-	-	
	6	-	-	-	-	-	-	-	●	-	-	-	-	-	-	●	-
	Space saving type union tee LQ3T-SN  P.936	2	-	-	●	-	-	-	-	-	-	●	-	-	-	-	-
3		-	-	-	●	●	-	-	-	-	-	●	-	-	-	-	
4		-	-	-	-	-	●	-	-	-	-	-	●	-	-	-	
5		-	-	-	-	-	-	●	-	-	-	-	-	●	-	-	
6		-	-	-	-	-	-	-	●	-	-	-	-	-	-	●	-
Space saving type panel mount union LQ3P-SN  P.936		2	-	-	●	-	-	-	-	-	-	●	-	-	-	-	-
	3	-	-	-	●	●	-	-	-	-	-	●	-	-	-	-	
	4	-	-	-	-	-	●	-	-	-	-	-	●	-	-	-	
	5	-	-	-	-	-	-	●	-	-	-	-	-	●	-	-	
	6	-	-	-	-	-	-	-	●	-	-	-	-	-	-	●	-
	Space saving type union LQ3U-SN  P.936	2	-	-	●	-	-	-	-	-	-	●	-	-	-	-	-
3		-	-	-	●	●	-	-	-	-	-	●	-	-	-	-	
4		-	-	-	-	-	●	-	-	-	-	-	●	-	-	-	
5		-	-	-	-	-	-	●	-	-	-	-	-	●	-	-	
6		-	-	-	-	-	-	-	●	-	-	-	-	-	-	●	-
Blanking plug LQ3-P-1  P.937		1	●	●	-	-	-	-	-	-	-	●	-	-	-	-	-
	2	-	-	●	-	-	-	-	-	-	-	●	-	-	-	-	
	3	-	-	-	●	●	-	-	-	-	-	-	●	-	-	-	
	4	-	-	-	-	-	●	-	-	-	-	-	-	●	-	-	
	5	-	-	-	-	-	-	●	-	-	-	-	-	-	●	-	
	6	-	-	-	-	-	-	-	●	-	-	-	-	-	-	●	-
	7	-	-	-	-	-	-	-	-	●	-	-	-	-	-	-	●
Tubing plug LQ3-P-2  P.937	1	●	●	-	-	-	-	-	-	-	●	-	-	-	-	-	
	2	-	-	●	-	-	-	-	-	-	-	●	-	-	-	-	
	3	-	-	-	●	●	-	-	-	-	-	-	●	-	-	-	
	4	-	-	-	-	-	●	-	-	-	-	-	-	●	-	-	
	5	-	-	-	-	-	-	●	-	-	-	-	-	-	●	-	
	6	-	-	-	-	-	-	-	●	-	-	-	-	-	-	●	-
	7	-	-	-	-	-	-	-	-	●	-	-	-	-	-	-	●
Nut LQ3-N  P.937	1	●	●	-	-	-	-	-	-	-	●	-	-	-	-	-	
	2	-	-	●	-	-	-	-	-	-	-	●	-	-	-	-	
	3	-	-	-	●	●	-	-	-	-	-	-	●	-	-	-	
	4	-	-	-	-	-	●	-	-	-	-	-	-	●	-	-	
	5	-	-	-	-	-	-	●	-	-	-	-	-	-	●	-	
	6	-	-	-	-	-	-	-	●	-	-	-	-	-	-	●	-
	7	-	-	-	-	-	-	-	-	●	-	-	-	-	-	-	●

LVN/LQHB Series / TL / TD / TH / TIL / TID / TIH

Needle Valve
/Bore Through Connector
/High Purity Fluoropolymer Tubing

Needle Valve **P.938**





Series	Appearance	Size	Tubing O.D.									
			Metric Size					Inch Size				
			ø4	ø6	ø8	ø10	ø12	1/8"	3/16"	1/4"	3/8"	1/2"
Needle valve LVN		2	●	○	-	-	-	●	●	○	-	-
		3	-	●	●	○	-	-	-	●	○	-
		4	-	-	-	●	○	-	-	-	●	○

Note) ○Basic size ●With reducer

Bore Through Connector **P.941**

Series	Appearance	Size	Tubing O.D.													
			Metric Size						Inch Size							
			ø3	ø4	ø6	ø8	ø10	ø12	ø19	ø25	1/8"	1/4"	3/8"	1/2"	3/4"	1"
Bore through connector LQHB		1	●	●	-	-	-	-	-	-	-	●	-	-	-	-
		2	-	-	●	-	-	-	-	-	-	-	●	-	-	-
		3	-	-	-	●	●	-	-	-	-	-	-	●	-	-
		4	-	-	-	-	-	●	-	-	-	-	-	-	●	-
		5	-	-	-	-	-	-	●	-	-	-	-	-	-	●
		6	-	-	-	-	-	-	-	-	●	-	-	-	-	-

High Purity Fluoropolymer Tubing **P.947**

Series		Tubing O.D.		Page
TL	Material: Super PFA 	Metric Size	ø4	P.948
			ø6	
			ø8	
			ø10	
			ø12	
			ø19	
TIL		Inch Size	1/8"	
	3/16"			
	1/4"			
	3/8"			
	1/2"			
	1/2"			
TLM	Material: PFA 	Metric Size	ø2, ø3, ø4, ø6, ø8, ø10, ø12, ø16, ø19, ø25	From page 949
TILM		Inch Size	1/8", 3/16", 1/4", 3/8", 1/2", 3/4", 1", 1 1/4"	
TD	Material: Modified PTFE (Polytetrafluoroethylene resin) 	Metric Size	ø4	From page 952
			ø6	
			ø8	
			ø10	
		ø12		
TID		Inch Size	1/8"	
			3/16"	
	1/4"			
			3/8"	
			1/2"	
			1/2"	
TH	Material: FEP 	Metric Size	ø4	From page 954
			ø6	
			ø8	
			ø10	
			ø12	
			ø12	
TIH		Inch Size	1/8"	
	3/16"			
	1/4"			
	3/8"			
			1/2"	
			1/2"	
			3/4"	

- LVC
- LVA
- LVH
- LVD
- LVQ
- LVP
- LVW
- LQ1
- LQ3
- LVN
- LQHB
- TL
- TIL
- TLM
- TILM
- TD
- TID
- TH
- TIH

Fluoropolymer Fittings Hyper Fittings



LQ1 Series

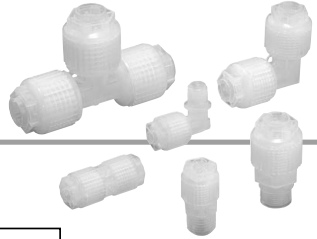

How to Order

Threaded connection

LQ1 H 11 [] - M [] - []

Fitting type

Symbol	Type
H	Connector
L	Elbow
R	Run tee
B	Branch tee

Thread type

Symbol	Type
Nil	R, Rc
N	NPT

Piping type

Symbol	Type
M	Male
F	Female

Packaging

Symbol	Packaging
Nil	Clean packaging equivalent to ISO Class 5
1	Standard packaging equivalent to ISO Class 7

Size combination

Symbol Class	No.	Applicable tubing size (mm)	Port size
1	1	4 x 3	1/8"
1	2	3 x 2	
2	1	6 x 4	
2	2	4 x 3	1/8"
2	C	3 x 2	
2	3	6 x 4	
2	4	4 x 3	1/4"
2	F	3 x 2	
3	1	10 x 8	
3	2	8 x 6	1/4"
3	3	6 x 4	
3	4	10 x 8	
3	5	8 x 6	3/8"
3	6	6 x 4	
3	7	4 x 3	
3	E	3 x 2	1/8"
3	9	10 x 8	
3	10	8 x 6	
4	1	12 x 10	3/8"
4	2	10 x 8	
4	3	12 x 10	
4	4	10 x 8	1/2"
4	5	8 x 6	
4	6	6 x 4	
4	F	3 x 2	1/4"
4	9	12 x 10	
5	1	19 x 16	
5	2	12 x 10	
5	3	19 x 16	
5	4	12 x 10	3/4"
5	5	10 x 8	
5	7	6 x 4	
5	8	19 x 16	1/4"
5	9	19 x 16	
5	1	25 x 22	
6	2	19 x 16	
6	3	25 x 22	
6	4	19 x 16	1"
6	5	12 x 10	
6	6	25 x 22	

Symbol Class	No.	Applicable tubing size (inch)	Port size	
1	A	1/8" x 0.086"	1/8"	
2	A	1/4" x 5/32"	1/8"	
2	B	3/16" x 1/8"		
2	C	1/8" x 0.086"		
2	D	1/4" x 5/32"	1/4"	
2	E	3/16" x 1/8"		
2	F	1/8" x 0.086"		
3	A	3/8" x 1/4"	1/4"	
3	B	1/4" x 5/32"		
3	C	3/8" x 1/4"		
3	D	1/4" x 5/32"	3/8"	
3	E	1/8" x 0.086"		
3	F	3/8" x 1/4"		
4	A	1/2" x 3/8"	3/8"	
4	B	3/8" x 1/4"		
4	C	1/2" x 3/8"		
4	D	3/8" x 1/4"	1/2"	
4	E	1/4" x 5/32"		
4	F	1/8" x 0.086"		
4	G	1/4" x 3/8"	1/4"	
5	A	3/4" x 5/8"		1/2"
5	B	1/2" x 3/8"		
5	C	3/4" x 5/8"		
5	D	1/2" x 3/8"	3/4"	
5	E	3/8" x 1/4"		
5	F	1/4" x 5/32"		
5	G	3/4" x 5/8"	1/4"	
5	H	3/4" x 5/8"		
6	A	1" x 7/8"		3/4"
6	B	3/4" x 5/8"		
6	C	1" x 7/8"		
6	D	3/4" x 5/8"	1"	
6	E	1/2" x 3/8"		
6	F	1" x 7/8"		1/2"

For different diameter (on B side)

Symbol	Application
Nil	Same tubing size
Refer to the applicable tubing table.	Different diameter tubing can be selected within the same body class.

LQ1B		LQ1R	
Branch tee male	Branch tee female	Run tee male	Run tee female

The table of combination is the same as that for A side.
 Note 1) Only branch tees and run tees can take different diameters.
 Note 2) Use of different diameters is not available with size 1.

Different diameter tubing order example

Different diameter tubing (with plug-in reducer) can be selected within the same body class. (Example) Branch tee male
 Body class 3
 A side: $\phi 10 \times \phi 8$ B side: $\phi 8 \times \phi 6$
 Order as shown below.

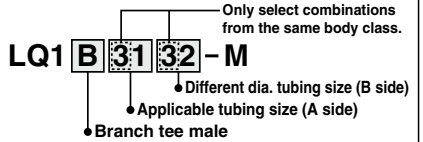

Tubing in inches can be combined with that in mm in the same body size. Example) LQ1B313A-M

Branch tee male/Female (LQ1B) How to Order

As this product is bilaterally symmetric (A side and B side), depending on the combination, 2 identical part numbers may be listed in series. Be sure to list symbols in ascending alphabetical order.

LQ1B 31 32 - M

Listed in ascending numerical order

Example 1) Ascending numerical order	Example 2) Ascending alphabetical order
Correct) LQ1B 31 32 -M	Correct) LQ1B 37 3E -M
Incorrect) LQ1B 32 31 -M	Incorrect) LQ1B 3E 37 -M

- Note 1) Tubing of different sizes can only be used in combination if within the same body class. However, for class 1, tubing of different sizes cannot be used in combination.
 Note 2) Combinations will differ depending on the type of each fitting. For the availability of combinations, refer to pages 877 to 884. These are produced upon receipt of order by part number.
 Note 3) For details of the applicable tubing sizes, refer to page 945.

How to Order

Tubing connection

LQ1 E 11 [] - []

•Packaging

Symbol	Packaging
NII	Clean packaging equivalent to ISO Class 5
1	Standard packaging equivalent to ISO Class 7

Fitting type

Symbol	Type
E	Union elbow
T	Union tee
P	Panel mount union
U	Union
F	Union flange

•Combination of different diameter (on B side)

Symbol Class	No.	Applicable tubing size (mm)
1	1	4 x 3
1	2	3 x 2
2	1	6 x 4
2	2	4 x 3
2	C	3 x 2
3	1	10 x 8
3	2	8 x 6
3	3	6 x 4
4	1	12 x 10
4	2	10 x 8
5	1	19 x 16
5	2	12 x 10
6	1	25 x 22
6	2	19 x 16

Symbol Class	No.	Applicable tubing size (inch)
1	A	1/8" x 0.086"
—	—	—
2	A	1/4" x 5/32"
2	B	3/16" x 1/8"
2	C	1/8" x 0.086"
3	A	3/8" x 1/4"
3	B	1/4" x 5/32"
4	A	1/2" x 3/8"
4	B	3/8" x 1/4"
5	A	3/4" x 5/8"
5	B	1/2" x 3/8"
6	A	1" x 7/8"
6	B	3/4" x 5/8"

Note 1) Tubing of different sizes can only be used in combination if within the same body class. However, use of different diameters is not available with size 1.

Note 2) For details of the applicable tubing sizes, refer to page 945.

Size combination

Symbol Class	No.	Applicable tubing size (mm)	Symbol Class	No.	Applicable tubing size (inch)	Applicable flange
1	1	4 x 3	1	A	1/8" x 0.086"	—
1	2	3 x 2	—	—	—	—
2	1	6 x 4	2	A	1/4" x 5/32"	—
2	2	4 x 3	2	B	3/16" x 1/8"	—
2	C	3 x 2	2	C	1/8" x 0.086"	—
3	1	10 x 8	3	A	3/8" x 1/4"	—
3	2	8 x 6	3	B	1/4" x 5/32"	—
3	3	6 x 4	4	A	1/2" x 3/8"	15A
4	1	12 x 10	4	B	3/8" x 1/4"	15A
4	2	10 x 8	5	A	3/4" x 5/8"	20A
5	1	19 x 16	5	B	1/2" x 3/8"	20A
5	2	12 x 10	6	A	1" x 7/8"	25A
6	1	25 x 22	6	B	3/4" x 5/8"	25A
6	2	19 x 16	—	—	—	—

Symbol	Application
NII	Same tubing size
Refer to the applicable tubing table.	Different diameter tubing can be selected within the same body class.
Union elbow LQ1E	Union tee LQ1T
Panel mount union LQ1P	Union LQ1U

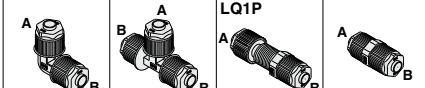

Note 1) Tubing of different sizes can only be used in combination if within the same body class. However, for class 1, tubing of different sizes cannot be used in combination.

Note 2) Sizes 1 to 3 are not available for the union flange.

Note 3) For Union flange, nut sizes 4 and 5 are as shown below.

LQ1F4□: LQ-4N□□

LQ1F5□: LQ-5N□□

Note 4) Combinations will differ depending on the type of each fitting. For the availability of combinations, refer to pages 885 to 888.

Note 5) For details of the applicable tubing sizes, refer to page 945.

Different diameter tubing order example

Different diameter tubing (with plug-in reducer) can be selected within the same body class.

(Example) Union elbow

Body class 3

A side: ø10 x ø8 B side: ø8 x ø6

Order as shown below.

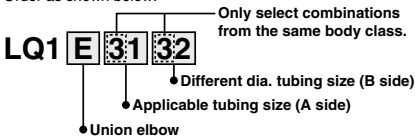

Tubing in inches can be combined with that in mm in the same body size. Example) LQ1E313A

Union elbow (LQ1E)/Union (LQ1U) How to Order

As this product is bilaterally symmetric (A side and B side), depending on the combination, 2 identical part numbers may be listed in series. Be sure to list symbols in ascending alphanumeric order.

LQ1E 31 32

Listed in ascending numerical order

Example 1) Ascending numerical order

Correct) LQ1E 31 32

Incorrect) LQ1E 32 31

Example 2) Ascending alphanumeric order

Correct) LQ1E 31 3A

Incorrect) LQ1E 3A 31



Specifications

Feature	Model	LQ1□10	LQ1□20	LQ1□30	LQ1□40	LQ1□50	LQ1□60
Material		NEW PFA ^{Note)}					
Maximum operating pressure (at 20°C)		1.0 MPa					
Proof pressure		Refer to the withstand pressure and heat resistance performance curves.					
Operating temperature		0 to 200°C					

Note) For products produced upon receipt of order, the fitting body is made of PTFE.

Withstand Pressure and Heat Resistance Performance

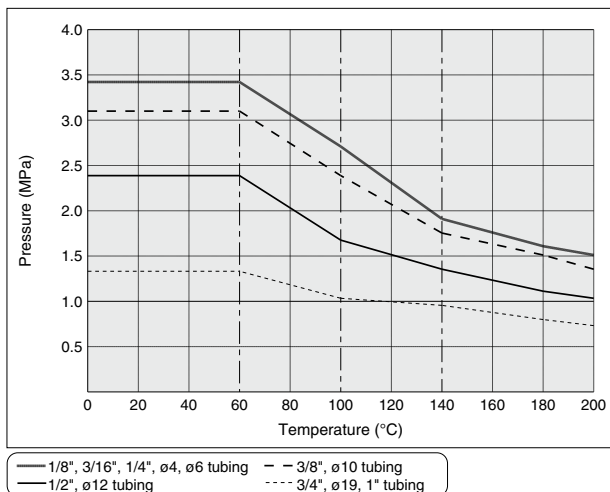

Piping

⚠ Caution

1. Connect tubing with special tools

Refer to the pamphlet "High-Purity Fluoropolymer Fittings Hyper Fitting/LQ1, 2 Series Work Procedure Instructions" (M-E05-1) for connecting tubing and special tools. (Downloadable from our web site.)

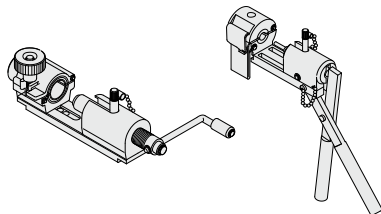

2. Tighten the nut until it touches the end surface of the body, and then tighten it an additional 1/8 turn. If the nut won't turn any further, then it means a sufficient tightening has occurred. Refer to the proper tightening torques shown below.

Tightening torque for piping

Body class	Torque (N·m)
2	0.3 to 0.4
3	0.8 to 1.0
4	1.0 to 1.2
5	2.5 to 3.0
6	5.5 to 6.0

Note) In the case of body class 1, the nut should be tightened manually.

Dimensions

Male Connector: LQ1H-M

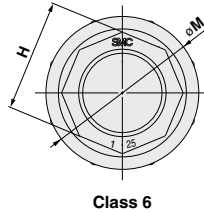
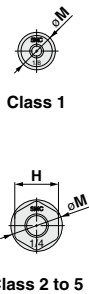
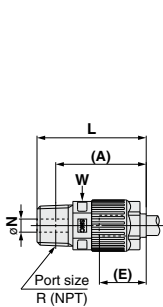

(A) shows the reference dimension after connection.
(E) shows the approximate dimension of the inserted tubing from the end of the nut.
"W" is width across flats dimension.

Metric sizes

Model	Applicable tubing O.D.	Connection threads R/NPT	A	E	H	L	M	N	Min. port size	W
LQ1H11-M	ø4	1/8"	21	10	—	25	11.5	4	2.6 1.8	10
LQ1H12-M	ø3								3.6	
LQ1H21-M	ø6	1/8"	31.5					4.4	1.8	14
LQ1H22-M	ø4			15	14	35	16.5	6	2.6 1.8	
LQ1H2C-M	ø3								3.6	
LQ1H23-M	ø6								3.6	
LQ1H24-M	ø4	1/4"	29					6	2.6 1.8	
LQ1H2F-M	ø3								1.8	
LQ1H31-M	ø10								6	
LQ1H32-M	ø8	1/4"	36.5					6	5.5 3.6	19
LQ1H33-M	ø6			20	17	42.5	23		7.4	
LQ1H34-M	ø10								5.5 3.6	
LQ1H35-M	ø8		36					10	3.6	
LQ1H36-M	ø6	3/8"							2.6	
LQ1H37-M	ø4		31.5	15	14	37.6	16.5		1.8	
LQ1H3E-M	ø3								4.4	
LQ1H39-M	ø10							4.4		
LQ1H310-M	ø8	1/8"	34.5	20	17	38	23	4.4	4.4	
LQ1H41-M	ø12								8	
LQ1H42-M	ø10	3/8"	46		24	21	52	28	7.4	
LQ1H43-M	ø12			44					9.4	
LQ1H44-M	ø10								7.4	
LQ1H45-M	ø8	1/2"						10	5.5	23
LQ1H46-M	ø6		39.5	20	17	47.5	23		3.6	
LQ1H4F-M	ø3			34	15	14	42	16.5	1.8	
LQ1H49-M	ø12	1/4"	42	24	21	48	28	6	6	
LQ1H51-M	ø19								10	
LQ1H52-M	ø12	1/2"	55					10	9.4	
LQ1H53-M	ø19			29	26	62.5	39		15	
LQ1H54-M	ø12		53.5					16	9.4	32
LQ1H55-M	ø10	3/4"		43.5	20	17	52.5	23	7.4	
LQ1H57-M	ø6								3.6	
LQ1H58-M	ø19	1/4"	52	29	26	58	39	6	6	
LQ1H59-M	ø19	3/8"						8	8	
LQ1H61-M	ø25								16	
LQ1H62-M	ø19	3/4"	72		39.5	36	81	49	15	
LQ1H63-M	ø25								21.2	
LQ1H64-M	ø19	1"	71					22.5	15	46
LQ1H65-M	ø12		61	29	26	71	39		9.4	
LQ1H66-M	ø25	1/2"	69.5	39.5	36	77.5	49	10	10	

Inch sizes

Model	Applicable tubing O.D.	Connection threads R/NPT	A	E	H	L	M	N	Min. port size	W
LQ1H1A-M	1/8"	1/8"	21	10	—	25	11.5	4	1.8	10
LQ1H2A-M	1/4"							4.4	3.6	
LQ1H2B-M	3/16"	1/8"	31.5						2.9	
LQ1H2C-M	1/8"			15	14	35	16.5	6	1.8	14
LQ1H2D-M	1/4"								3.6	
LQ1H2E-M	3/16"	1/4"	29						2.9	
LQ1H2F-M	1/8"								1.8	
LQ1H3A-M	3/8"							6	5.8	
LQ1H3B-M	1/4"	1/4"	36.5						3.6	
LQ1H3C-M	3/8"			20	17	42.5	23		5.8	
LQ1H3D-M	1/4"	3/8"						10	3.6	19
LQ1H3E-M	1/8"		31.5	15	14	37.6	16.5		1.8	
LQ1H3F-M	3/8"	1/8"	34.5	20	17	38	23	4.4	4.4	
LQ1H4A-M	1/2"								8	
LQ1H4B-M	3/8"	3/8"	46					8	5.8	
LQ1H4C-M	1/2"			24	21	52	28		9	
LQ1H4D-M	3/8"		44					10	5.8	23
LQ1H4E-M	1/4"	1/2"	39.5	20	17	47.5	23		3.6	
LQ1H4F-M	1/8"		34	15	14	42	16.5		1.8	
LQ1H4G-M	1/2"	1/4"	42	24	21	48	28	6	6	
LQ1H5A-M	3/4"								10	
LQ1H5B-M	1/2"	1/2"	55					10	9	
LQ1H5C-M	3/4"			29	26	62.5	39		15	
LQ1H5D-M	1/2"	3/4"	53.5					16	9	32
LQ1H5E-M	3/8"			43.5	20	17	52.5	23	5.8	
LQ1H5F-M	1/4"								3.6	
LQ1H5G-M	3/4"	1/4"	52	29	26	58	39		6	
LQ1H5H-M	1"	3/8"							8	
LQ1H6A-M	1"								16	
LQ1H6B-M	3/4"	3/4"	72		39.5	36	81	49	15	
LQ1H6C-M	1"								21.2	
LQ1H6D-M	3/4"	1"	71					22.5	15	46
LQ1H6E-M	1/2"		61	29	26	71	39		9	
LQ1H6F-M	1"	1/2"	69.5	39.5	36	77.5	49	10	10	

LVC
LVA
LVH
LVD
LVQ
LVP
LVW
LQ1
LQ3
LVN
LQHB
TL TIL
TLM TILM
TD TID
TH TIH

LQ1 Series

Dimensions

Female Connector: LQ1H-F

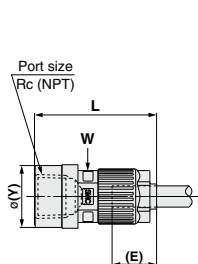

Class 1



Class 2 to 5

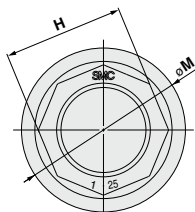

Class 6

(E) shows the reference of the inserted tubing from the end of the nut.

"W" is width across flats dimension.

Metric sizes

Model	Applicable tubing O.D.	Connection threads Rc/NPT	E	H	L	M	Min. port size	W	Y
LQ1H11-F□	ø4						2.6		
LQ1H12-F□	ø3	1/8"	10	—	26.5	11.5	1.8	10	18.5
LQ1H21-F□	ø6						3.6		
LQ1H22-F□	ø4	1/8"			35		2.6		18.5
LQ1H2C-F□	ø3		15	14		16.5	1.8	14	
LQ1H23-F□	ø6						3.6		
LQ1H24-F□	ø4	1/4"			36.5		2.6		21.5
LQ1H2F-F□	ø3						1.8		
LQ1H31-F□	ø10						7.4		
LQ1H32-F□	ø8	1/4"					5.5		21.5
LQ1H33-F□	ø6						3.6		
LQ1H34-F□	ø10						7.4		
LQ1H35-F□	ø8	3/8"	20	17	42.5	23	5.5	19	25
LQ1H36-F□	ø6						3.6		
LQ1H39-F□	ø10						7.4		
LQ1H310-F□	ø8	1/8"					5.5		18.5
LQ1H41-F□	ø12						9.4		
LQ1H42-F□	ø10						7.4		
LQ1H43-F□	ø12		24	21		28	9.4		
LQ1H44-F□	ø10				50		7.4	23	
LQ1H45-F□	ø8						5.5		29.5
LQ1H46-F□	ø6	1/2"					3.6		
LQ1H49-F□	ø12	1/4"	29	26	56.5	39	9.4	32	21.5
LQ1H410-F□	ø12	1/8"	24	21	46.5	28	8.2	23	18.5
LQ1H51-F□	ø19						15		
LQ1H52-F□	ø12	1/2"			58.5		9.4		29.5
LQ1H53-F□	ø19						15		
LQ1H54-F□	ø12	3/4"	29	26	60	39	9.4	32	36
LQ1H58-F□	ø19	1/4"			56.5		10.7		21.5
LQ1H59-F□	ø19	3/8"			56		14		25
LQ1H61-F□	ø25						21.2		
LQ1H62-F□	ø19	3/4"			75	49	15		36
LQ1H63-F□	ø25		39.5	36			21.2	46	
LQ1H64-F□	ø19	1"			78.5		15		44.5

Inch sizes

Model	Applicable tubing O.D.	Connection threads Rc/NPT	E	H	L	M	Min. port size	W	Y
LQ1H1A-F□	1/8"	1/8"	10	—	26.5	11.5	1.8	10	18.5
LQ1H2A-F□	1/4"						3.6		
LQ1H2B-F□	3/16"	1/8"			35		2.9		18.5
LQ1H2C-F□	1/8"		15	14		16.5	1.8	14	
LQ1H2D-F□	1/4"						3.6		
LQ1H2E-F□	3/16"	1/4"			36.5		2.9		21.5
LQ1H2F-F□	1/8"						1.8		
LQ1H3A-F□	3/8"						5.8		
LQ1H3B-F□	1/4"	1/4"					3.6		21.5
LQ1H3C-F□	3/8"	3/8"	20	17	42.5	23	5.8	19	
LQ1H3D-F□	1/4"						3.6		25
LQ1H3F-F□	3/8"	1/8"					5.8		18.5
LQ1H4A-F□	1/2"						9		
LQ1H4B-F□	3/8"	3/8"	24	21	47.5	28	5.8	23	25
LQ1H4C-F□	1/2"				50		9		
LQ1H4D-F□	3/8"	1/2"					5.8		29.5
LQ1H4E-F□	1/4"	1/2"	20	17	45.5	23	3.6		
LQ1H4G-F□	1/2"	1/4"	29	26	56.5	39	9	32	21.5
LQ1H4H-F□	1/2"	1/8"	24	21	46.5	28	8.2	23	18.5
LQ1H5A-F□	3/4"						15		
LQ1H5B-F□	1/2"	1/2"			58.5		9		29.5
LQ1H5C-F□	3/4"						15		
LQ1H5D-F□	1/2"	3/4"	29	26	60	39	9	32	36
LQ1H5G-F□	3/4"	1/4"			56.5		10.7		21.5
LQ1H5H-F□	3/4"	3/8"			56		14		25
LQ1H6A-F□	1"						21.2		
LQ1H6B-F□	3/4"	3/4"	39.5	36	75	49	15	46	36
LQ1H6C-F□	1"						21.2		
LQ1H6D-F□	3/4"	1"			78.5		15		44.5

Male Elbow: LQ1L-M

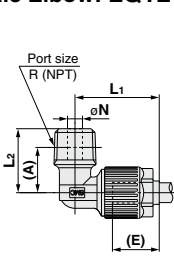

Class 1

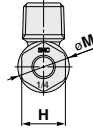

Class 2 to 5

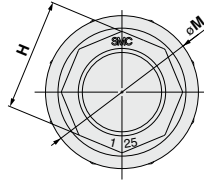

Class 6

(A) shows the reference dimension after connection.
(E) shows the approximate dimension of the inserted tubing from the end of the nut.

Metric sizes

Model	Applicable tubing O.D.	Connection threads R/NPT	A	E	H	L ₁	L ₂	M	N	Min. port size
LQ1L11-M□	ø4	1/8"	11.5	10	—	18	15	11.5	4	2.6
LQ1L12-M□	ø3									1.8
LQ1L21-M□	ø6									3.6
LQ1L22-M□	ø4	1/8"							4.4	2.6
LQ1L2C-M□	ø3									1.8
LQ1L23-M□	ø6		14.5	15	14	27	20.5	16.5		3.6
LQ1L24-M□	ø4								6	2.6
LQ1L2F-M□	ø3	1/4"								1.8
LQ1L31-M□	ø10									6
LQ1L32-M□	ø8	1/4"							6	5.5
LQ1L33-M□	ø6									3.6
LQ1L34-M□	ø10		20	20	17	35	26.5	23		7.4
LQ1L35-M□	ø8									5.5
LQ1L36-M□	ø6								8	3.6
LQ1L37-M□	ø4									2.6
LQ1L3E-M□	ø3	3/8"								1.8
Note 2) LQ1L39-M	ø10									4
Note 2) LQ1L310-M	ø8	1/8"	20.6	20	17	36.6	24.1	23	4	4
LQ1L41-M□	ø12	3/8"							8	8
LQ1L42-M□	ø10									7.4
LQ1L43-M□	ø12		25	24	21	45	33	28		9.4
LQ1L44-M□	ø10									7.4
LQ1L45-M□	ø8									5.5
LQ1L46-M□	ø6	1/2"	24.1	20	17	38.5	32.1	23	10	3.6
* LQ1L47-M□	ø4									2.6
* LQ1L4F-M□	ø3		17.5	15	14	30	25.5	16.5		1.8
LQ1L49-M□	ø12	1/4"	22.6	24	21	43	28.6	28	6	6
LQ1L51-M□	ø19									10
LQ1L52-M□	ø12	1/2"							10	9.4
LQ1L53-M□	ø19		29	26	54	40	39			15
LQ1L54-M□	ø12		30.5							9.4
LQ1L55-M□	ø10	3/4"							16	7.4
LQ1L56-M□	ø8		20	17	44	39.5	23			5.5
LQ1L57-M□	ø6									3.6
* LQ1L59-M□	ø19	3/8"	34	39.5	36	53	40	49	8	8
LQ1L61-M□	ø25									16
LQ1L62-M□	ø19	3/4"	35	39.5	36	68.5	46	49		15
LQ1L63-M□	ø25									21.2
LQ1L64-M□	ø19	1"							22.5	15
LQ1L65-M□	ø12		37	29	26	60	47	39		9.4
* LQ1L67-M□	ø25	3/8"	34	39.5	36	53	40	49	8	8

Note 1) Products marked "*" are produced upon receipt of order. (The body of the fitting is PTFE machined.)
Note 2) NPT is not available for the thread type.

Inch sizes

Model	Applicable tubing O.D.	Connection threads R/NPT	A	E	H	L ₁	L ₂	M	N	Min. port size
LQ1L1A-M□	1/8"	1/8"	11.5	10	—	18	15	11.5	4	1.8
LQ1L2A-M□	1/4"									3.6
LQ1L2B-M□	3/16"	1/8"							4.4	2.9
LQ1L2C-M□	1/8"		14.5	15	14	27	20.5	16.5		1.8
LQ1L2D-M□	1/4"									3.6
LQ1L2E-M□	3/16"	1/4"							6	2.9
LQ1L2F-M□	1/8"									1.8
LQ1L3A-M□	3/8"									5.8
LQ1L3B-M□	1/4"	1/4"							6	3.6
LQ1L3C-M□	3/8"		20	20	17	35	26.5	23		5.8
LQ1L3D-M□	1/4"	3/8"							8	3.6
LQ1L3E-M□	1/8"		21.1	15	14	31.6	27.1	16.5		1.8
Note 2) LQ1L3F-M	3/8"	1/8"	20.6	20	17	36.6	24.1	23	4	4
LQ1L4A-M□	1/2"									8
LQ1L4B-M□	3/8"	3/8"							8	5.8
LQ1L4C-M□	1/2"		25	24	21	45	33	28		9
LQ1L4D-M□	3/8"									5.8
LQ1L4E-M□	1/4"	1/2"	24.1	20	17	38.5	32.1	23	10	3.6
* LQ1L4F-M□	1/8"		17.5	15	14	30	25.5	16.5		1.8
LQ1L4G-M□	1/2"	1/4"	22.6	24	21	43	28.6	28	6	9
LQ1L5A-M□	3/4"									10
LQ1L5B-M□	1/2"	1/2"								9
LQ1L5C-M□	3/4"		29	26	54	40	39			15
LQ1L5D-M□	1/2"	3/4"							16	9
LQ1L5E-M□	3/8"									5.8
LQ1L5F-M□	1/4"		20	17	44	39.5	23			3.6
* LQ1L5H-M□	3/4"	3/8"	34	39.5	36	53	40	49	8	8
LQ1L6A-M□	1"	3/4"							16	16
LQ1L6B-M□	3/4"		35	39.5	36	68.5	46	49		15
LQ1L6C-M□	1"									21.2
LQ1L6D-M□	3/4"	1"							22.5	15
LQ1L6E-M□	1/2"		37	29	26	60	47	39		9
* LQ1L6G-M□	1"	3/8"	34	39.5	36	53	40	49	8	8

Note 1) Products marked "*" are produced upon receipt of order. (The body of the fitting is PTFE machined.)
Note 2) NPT is not available for the thread type.

LVC

LVA

LVH

LVD

LVQ

LVP

LVV

LQ1

LQ3

LVN

LQHB

TL

TIL

TLM

TILM

TD

TID

TH

TIH

LQ1 Series

Dimensions

Female Elbow: LQ1L-F

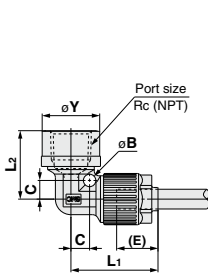

Class 1

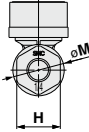

Class 2 to 5

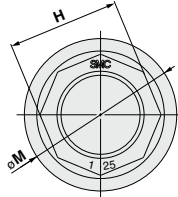

Class 6

(E) shows the reference dimension of the inserted tubing from the end of the nut.

Metric sizes

Model	Applicable tubing O.D.	Connection threads Rc/NPT	B	C	E	H	L ₁	L ₂	M	Min. port size	Y
LQ1L11-F	ø4	1/8"	2	4	10	—	18.5	16	11.5	2.6	18.5
LQ1L12-F	ø3									1.8	
LQ1L21-F	ø6									3.6	
LQ1L22-F	ø4	1/8"						19.5		2.6	18.5
LQ1L2C-F	ø3		4	6	15	14	28		16.5	1.8	
LQ1L23-F	ø6									3.6	
LQ1L24-F	ø4	1/4"						22		2.6	21.5
LQ1L2F-F	ø3									1.8	
LQ1L31-F	ø10									7.4	
LQ1L32-F	ø8	1/4"						22		5.5	21.5
LQ1L33-F	ø6									3.6	
LQ1L34-F	ø10			20	17	36.5		23		7.4	
LQ1L35-F	ø8		5	9				24.5		5.5	25
LQ1L36-F	ø6	3/8"								3.6	
LQ1L3E-F	ø3			15	14	31.6	24.5	16.5		1.8	
Note) LQ1L39-F	ø10									7.4	
Note) LQ1L310-F	ø8	1/8"		20	17	36.6	21.8	23		5.5	18.5
LQ1L41-F	ø12	3/8"						25.5		9.4	25
LQ1L42-F	ø10									7.4	
LQ1L43-F	ø12									9.4	
LQ1L44-F	ø10	1/2"	6	9	24	21	43	30.5	28	7.4	29.5
LQ1L49-F	ø12	1/4"								9.4	21.5
LQ1L410-F	ø12	1/8"						23.8		8	18.5
LQ1L51-F	ø19									15	29.5
LQ1L52-F	ø12	1/2"						35.5		9.4	
LQ1L53-F	ø19									15	36
LQ1L54-F	ø12	3/4"	7	14	29	26	54	37	39	9.4	36
LQ1L59-F	ø19	3/8"						30.5		14	25
LQ1L61-F	ø25									21.2	36
LQ1L62-F	ø19	3/4"						42.5	49	15	
LQ1L63-F	ø25		8	18	39.5	36	69.5			21.2	44.5
LQ1L64-F	ø19	1"						46		15	

Note) NPT is not available for the thread type.

Inch sizes

Model	Applicable tubing O.D.	Connection threads Rc/NPT	B	C	E	H	L ₁	L ₂	M	Min. port size	Y
LQ1L1A-F	1/8"	1/8"	2	4	10	—	18.5	16	11.5	1.8	18.5
LQ1L2A-F	1/4"									3.6	
LQ1L2B-F	3/16"	1/8"						19.5		2.9	18.5
LQ1L2C-F	1/8"		4	6	15	14	28		16.5	1.8	
LQ1L2D-F	1/4"									3.6	
LQ1L2E-F	3/16"	1/4"						22		2.9	21.5
LQ1L2F-F	1/8"									1.8	
LQ1L3A-F	3/8"									5.8	21.5
LQ1L3B-F	1/4"	1/4"			20	17	36.5		23	5.8	
LQ1L3C-F	3/8"		5	9				24.5		3.6	25
LQ1L3D-F	1/4"	3/8"								3.6	
LQ1L3E-F	1/8"			15	14	31.6		16.5		1.8	
Note) LQ1L3F-F	3/8"	1/8"					36.6	21.8	23	5.8	18.5
LQ1L4A-F	1/2"							25.5		9	25
LQ1L4B-F	3/8"	3/8"								5.8	
LQ1L4C-F	1/2"		6	9	24	21	43	30.5	28	9	29.5
LQ1L4D-F	3/8"	1/2"								5.8	
LQ1L4G-F	1/2"	1/4"								9	21.5
LQ1L4H-F	1/2"	1/8"						23.8		8	18.5
LQ1L5A-F	3/4"									35.5	15
LQ1L5B-F	1/2"	1/2"								9	29.5
LQ1L5C-F	3/4"		7	14	29	26	54	37	39	15	36
LQ1L5D-F	1/2"	3/4"								9	
LQ1L5H-F	3/4"	3/8"						30.5		14	25
LQ1L6A-F	1"									21.2	36
LQ1L6B-F	3/4"	3/4"	8	18	39.5	36	69.5	46	49	15	
LQ1L6C-F	1"									21.2	44.5
LQ1L6D-F	3/4"	1"								15	

Note) NPT is not available for the thread type.

Male Run Tee: LQ1R-M

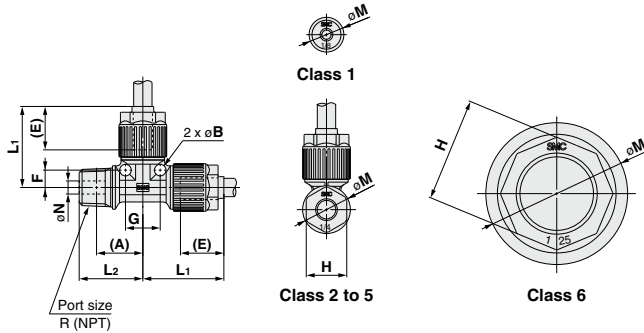

(A) shows the reference dimension after connection.
(E) shows the approximate dimension of the inserted tubing from the end of the nut.

Metric sizes

Model	Applicable tubing O.D.	Connection threads R/NPT	A	B	E	F	G	H	L ₁	L ₂	M	N	Min. port size
LQ1R11-M	ø4	1/8"	12	2	10	4	8	—	18.5	15.5	11.5	3	2.6
LQ1R12-M	ø3	1/8"	12	2	10	4	8	—	18.5	15.5	11.5	2	1.8
LQ1R21-M	ø6	1/8"	12	2	10	4	8	—	18.5	15.5	11.5	3	2.6
LQ1R22-M	ø4	1/8"	12	2	10	4	8	—	18.5	15.5	11.5	2	1.8
LQ1R23-M	ø3	1/8"	12	2	10	4	8	—	18.5	15.5	11.5	2	1.8
LQ1R23-M	ø6	1/8"	16	4	15	6	12	14	28	—	16.5	4.4	3.6
LQ1R24-M	ø4	1/4"	16	4	15	6	12	14	28	—	16.5	4.4	2.6
LQ1R2F-M	ø3	1/4"	16	4	15	6	12	14	28	—	16.5	4.4	1.8
LQ1R31-M	ø10	1/4"	19	5	20	9	18	—	36.5	25	—	8	7.4
LQ1R32-M	ø8	1/4"	19	5	20	9	18	—	36.5	25	—	8	5.5
LQ1R33-M	ø6	1/4"	19	5	20	9	18	—	36.5	25	—	8	3.6
LQ1R34-M	ø10	3/8"	21	5	20	9	18	—	36.5	27	23	—	7.4
LQ1R35-M	ø8	3/8"	21	5	20	9	18	—	36.5	27	23	—	5.5
LQ1R36-M	ø6	3/8"	21	5	20	9	18	—	36.5	27	23	—	3.6
*LQ1R39-M	ø10	1/8"	17	—	—	—	—	—	34.5	20.5	—	4.4	4.4
*LQ1R310-M	ø8	1/8"	17	—	—	—	—	—	34.5	20.5	—	4.4	4.4
LQ1R41-M	ø12	3/8"	23	6	24	9	18	21	43	29	—	10	9.4
LQ1R42-M	ø10	3/8"	23	6	24	9	18	21	43	29	—	10	7.4
LQ1R43-M	ø12	1/2"	24.5	6	24	9	18	21	43	32	—	10	9.4
LQ1R44-M	ø10	1/2"	24.5	6	24	9	18	21	43	32	—	10	7.4
LQ1R49-M	ø12	1/4"	27.5	7	29	14	28	26	54	33.5	39	6	6
LQ1R51-M	ø19	1/2"	30.5	7	29	14	28	26	54	38	—	10	10
LQ1R52-M	ø12	1/2"	30.5	7	29	14	28	26	54	38	—	10	9.4
LQ1R53-M	ø19	3/4"	30	7	29	14	28	26	54	39	39	16	15
LQ1R54-M	ø12	3/4"	30	7	29	14	28	26	54	39	39	16	9.4
LQ1R58-M	ø19	1/4"	27.5	7	29	14	28	26	54	33.5	—	6	6
LQ1R59-M	ø19	3/8"	29	7	29	14	28	26	54	35	—	10	10
LQ1R61-M	ø25	3/4"	36	8	39.5	18	36	36	69.5	45	49	16	16
LQ1R62-M	ø19	3/4"	36	8	39.5	18	36	36	69.5	45	49	16	15
LQ1R63-M	ø25	1"	35	8	39.5	18	36	36	69.5	45	49	16	21.2
LQ1R64-M	ø19	1"	35	8	39.5	18	36	36	69.5	45	49	16	15

Note) Products marked "*" are produced upon receipt of order.
(The body of the fitting is PTFE machined.)

Inch sizes

Model	Applicable tubing O.D.	Connection threads R/NPT	A	B	E	F	G	H	L ₁	L ₂	M	N	Min. port size
LQ1R1A-M	1/8"	1/8"	12	2	10	4	8	—	18.5	15.5	11.5	2	1.8
LQ1R2A-M	1/4"	1/4"	12	2	10	4	8	—	18.5	15.5	11.5	2	3.6
LQ1R2B-M	3/16"	1/8"	12	2	10	4	8	—	18.5	15.5	11.5	2	2.9
LQ1R2C-M	1/8"	1/8"	16	4	15	6	12	14	28	—	16.5	4.4	1.8
LQ1R2D-M	1/4"	1/4"	16	4	15	6	12	14	28	—	16.5	4.4	3.6
LQ1R2E-M	3/16"	1/4"	16	4	15	6	12	14	28	—	16.5	4.4	2.9
LQ1R2F-M	1/8"	1/4"	16	4	15	6	12	14	28	—	16.5	4.4	1.8
LQ1R3A-M	3/8"	3/8"	19	5	20	9	18	—	36.5	25	—	8	5.8
LQ1R3B-M	1/4"	1/4"	19	5	20	9	18	—	36.5	25	—	8	3.6
LQ1R3C-M	3/8"	3/8"	21	5	20	9	18	—	36.5	27	23	—	5.8
LQ1R3D-M	1/4"	1/4"	21	5	20	9	18	—	36.5	27	23	—	3.6
*LQ1R3F-M	3/8"	1/8"	17	—	—	—	—	—	34.5	20.5	—	4.4	4.4
LQ1R4A-M	1/2"	3/8"	23	6	24	9	18	21	43	29	—	10	9
LQ1R4B-M	3/8"	3/8"	23	6	24	9	18	21	43	29	—	10	5.8
LQ1R4C-M	1/2"	1/2"	24.5	6	24	9	18	21	43	32	—	10	9
LQ1R4D-M	3/8"	1/2"	24.5	6	24	9	18	21	43	32	—	10	5.8
LQ1R4G-M	1/2"	1/4"	27.5	7	29	14	28	26	54	33.5	39	6	6
LQ1R5A-M	3/4"	1/2"	30.5	7	29	14	28	26	54	38	—	10	10
LQ1R5B-M	1/2"	1/2"	30.5	7	29	14	28	26	54	38	—	10	9
LQ1R5C-M	3/4"	3/4"	30	7	29	14	28	26	54	39	39	16	15
LQ1R5D-M	1/2"	3/4"	30	7	29	14	28	26	54	39	39	16	9
LQ1R5G-M	3/4"	1/4"	27.5	7	29	14	28	26	54	33.5	—	6	6
LQ1R5H-M	3/4"	3/8"	29	7	29	14	28	26	54	35	—	10	10
LQ1R6A-M	1"	3/4"	36	8	39.5	18	36	36	69.5	45	49	16	16
LQ1R6B-M	3/4"	3/4"	36	8	39.5	18	36	36	69.5	45	49	16	15
LQ1R6C-M	1"	1"	35	8	39.5	18	36	36	69.5	45	49	16	21.2
LQ1R6D-M	3/4"	1"	35	8	39.5	18	36	36	69.5	45	49	16	15

Note) Products marked "*" are produced upon receipt of order.
(The body of the fitting is PTFE machined.)

LVC
LVA
LVH
LVD
LVQ
LVP
LVV
LQ1
LQ3
LVN
LQHB
TL TIL
TLM TILM
TD TID
TH TIH

LQ1 Series

Dimensions

Female Run Tee: LQ1R-F



Class 1

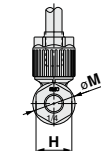
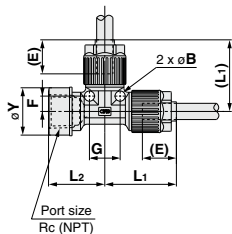

Class 2 to 5

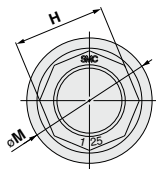

Class 6

(E) shows the approximate dimension of the inserted tubing from the end of the nut.

Metric sizes

Model	Applicable tubing O.D.	Connection threads Rc/NPT	B	E	F	G	H	L ₁	L ₂	M	Min. port size	Y
LQ1R11-F	ø4	1/8"	2	10	4	8	—	18.5	16	11.5	2.6	18.5
LQ1R12-F	ø3	1/8"	—	—	—	—	—	—	—	—	1.8	3.6
LQ1R21-F	ø6	1/8"	—	—	—	—	—	—	—	—	2.6	3.6
LQ1R22-F	ø4	1/8"	—	—	—	—	—	—	19.5	—	1.8	18.5
LQ1R2C-F	ø3	1/8"	—	—	—	—	—	—	—	—	2.6	3.6
LQ1R23-F	ø6	1/8"	4	15	6	12	14	28	—	16.5	3.6	18.5
LQ1R24-F	ø4	1/4"	—	—	—	—	—	—	22	—	2.6	21.5
LQ1R2F-F	ø3	1/4"	—	—	—	—	—	—	—	—	1.8	3.6
LQ1R31-F	ø10	1/4"	—	—	—	—	—	—	24	—	7.4	21.5
LQ1R32-F	ø8	1/4"	—	—	—	—	—	—	—	—	5.5	3.6
LQ1R33-F	ø6	1/4"	—	—	—	—	—	—	36.5	—	3.6	25
LQ1R34-F	ø10	1/4"	5	20	9	18	17	—	—	23	7.4	25
LQ1R35-F	ø8	3/8"	—	—	—	—	—	—	25.5	—	5.5	3.6
LQ1R36-F	ø6	3/8"	—	—	—	—	—	—	—	—	3.6	18.5
*LQ1R39-F	ø10	1/8"	—	—	—	—	—	—	34.5	19.7	7.4	25
*LQ1R310-F	ø8	1/8"	—	—	—	—	—	—	—	—	5.5	18.5
LQ1R41-F	ø12	3/8"	—	—	—	—	—	—	25	—	9.4	25
LQ1R42-F	ø10	3/8"	—	—	—	—	—	—	—	—	7.4	29.5
LQ1R43-F	ø12	1/2"	6	24	9	18	21	43	31.5	28	9.4	29.5
LQ1R44-F	ø10	1/2"	—	—	—	—	—	—	—	—	7.4	21.5
*LQ1R49-F	ø12	1/4"	—	—	—	—	—	—	41.5	21.2	9.4	21.5
LQ1R51-F	ø19	1/2"	—	—	—	—	—	—	35.5	—	15	29.5
LQ1R52-F	ø12	1/2"	—	—	—	—	—	—	—	—	9.4	36
LQ1R53-F	ø19	3/4"	7	29	14	28	26	54	37	39	15	36
LQ1R54-F	ø12	3/8"	—	—	—	—	—	—	30.5	—	9.4	25
LQ1R59-F	ø19	3/8"	—	—	—	—	—	—	—	—	14	25
LQ1R61-F	ø25	3/4"	—	—	—	—	—	—	42.5	—	21.2	36
LQ1R62-F	ø19	3/4"	—	—	—	—	—	—	—	—	15	44.5
LQ1R63-F	ø25	1"	8	39.5	18	36	36	69.5	46	49	21.2	44.5
LQ1R64-F	ø19	1"	—	—	—	—	—	—	—	—	15	21.2
LQ1R66-F	ø25	1/2"	—	—	—	—	—	—	41	—	17.8	29.5

Note) Products marked "*" are produced upon receipt of order.
(The body of the fitting is PTFE machined.)

Inch sizes

Model	Applicable tubing O.D.	Connection threads Rc/NPT	B	E	F	G	H	L ₁	L ₂	M	Min. port size	Y
LQ1R1A-F	1/8"	1/8"	2	10	4	8	—	18.5	16	11.5	1.8	18.5
LQ1R2A-F	1/4"	1/4"	—	—	—	—	—	—	—	—	3.6	18.5
LQ1R2B-F	3/16"	1/8"	—	—	—	—	—	—	19.5	—	2.9	18.5
LQ1R2C-F	1/8"	1/8"	4	15	6	12	14	28	—	16.5	1.8	18.5
LQ1R2D-F	1/4"	1/4"	—	—	—	—	—	—	—	—	3.6	21.5
LQ1R2E-F	3/16"	1/4"	—	—	—	—	—	—	22	—	2.9	21.5
LQ1R2F-F	1/8"	1/4"	—	—	—	—	—	—	—	—	1.8	21.5
LQ1R3A-F	3/8"	1/4"	—	—	—	—	—	—	24	—	5.8	21.5
LQ1R3B-F	1/4"	1/4"	—	—	—	—	—	—	—	—	3.6	21.5
LQ1R3C-F	3/8"	3/8"	5	20	9	18	17	36.5	25.5	23	5.8	25
LQ1R3D-F	1/4"	3/8"	—	—	—	—	—	—	—	—	3.6	18.5
*LQ1R3F-F	3/8"	1/8"	—	—	—	—	—	—	34.5	19.7	5.8	18.5
LQ1R4A-F	1/2"	3/8"	—	—	—	—	—	—	—	—	9	25
LQ1R4B-F	3/8"	3/8"	6	24	9	18	21	43	31.5	28	5.8	29.5
LQ1R4C-F	1/2"	1/2"	—	—	—	—	—	—	—	—	9	29.5
LQ1R4D-F	3/8"	3/8"	—	—	—	—	—	—	—	—	5.8	29.5
*LQ1R4G-F	1/2"	1/4"	—	—	—	—	—	—	41.5	21.2	9	21.5
LQ1R5A-F	3/4"	1/2"	—	—	—	—	—	—	35.5	—	15	29.5
LQ1R5B-F	1/2"	1/2"	7	29	14	28	26	54	37	39	15	36
LQ1R5C-F	3/4"	3/4"	—	—	—	—	—	—	—	—	9	36
LQ1R5D-F	1/2"	3/8"	—	—	—	—	—	—	30.5	—	14	25
LQ1R5H-F	3/4"	3/8"	—	—	—	—	—	—	—	—	14	25
LQ1R6A-F	1"	3/4"	8	39.5	18	36	36	69.5	42.5	49	21.2	36
LQ1R6B-F	3/4"	1"	—	—	—	—	—	—	—	—	15	21.2
LQ1R6C-F	1"	1"	—	—	—	—	—	—	46	—	21.2	44.5
LQ1R6D-F	3/4"	1"	—	—	—	—	—	—	—	—	15	44.5

Note) Products marked "*" are produced upon receipt of order.
(The body of the fitting is PTFE machined.)

Male Branch Tee: LQ1B-M

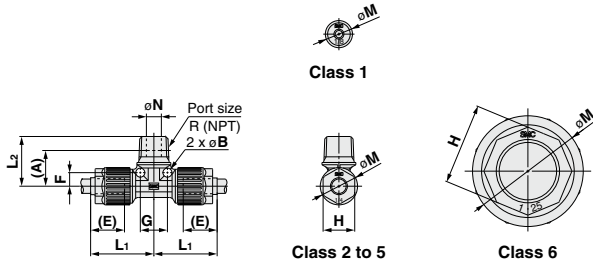

(A) shows the reference dimension after connection.
(E) shows the approximate dimension of the inserted tubing from the end of the nut.

Metric sizes

Model	Applicable tubing O.D.	Connection threads R/NPT	A	B	E	F	G	H	L ₁	L ₂	M	N	Min. port size
LQ1B11-M	ø4	1/8"	12	2	10	4	8	—	18.5	15.5	11.5	3	2.6
LQ1B12-M	ø3	1/8"	—	—	—	—	—	—	—	—	—	2	1.8
LQ1B21-M	ø6	1/8"	—	—	—	—	—	—	—	—	—	—	3.6
LQ1B22-M	ø4	1/8"	—	—	—	—	—	—	—	19.5	—	—	2.6
LQ1B23-M	ø3	1/8"	16	4	15	6	12	14	28	—	16.5	4.4	1.8
LQ1B23-M	ø6	1/8"	—	—	—	—	—	—	—	—	—	—	3.6
LQ1B24-M	ø4	1/4"	—	—	—	—	—	—	—	22	—	—	2.6
LQ1B2F-M	ø3	1/4"	—	—	—	—	—	—	—	—	—	—	1.8
LQ1B31-M	ø10	1/4"	19	—	—	—	—	—	—	—	—	—	7.4
LQ1B32-M	ø8	1/4"	—	—	—	—	—	—	—	25	—	—	5.5
LQ1B33-M	ø6	1/4"	—	—	—	—	—	—	—	—	—	—	3.6
LQ1B34-M	ø10	3/8"	21	5	20	9	18	—	36.5	—	8	—	7.4
LQ1B35-M	ø8	3/8"	—	—	—	—	—	—	—	27	23	—	5.5
LQ1B36-M	ø6	3/8"	—	—	—	—	—	—	—	—	—	—	3.6
* LQ1B39-M	ø10	1/8"	18.4	—	—	—	—	—	29	21.9	—	4.4	4.4
* LQ1B310-M	ø8	1/8"	—	—	—	—	—	—	—	—	—	—	4.4
LQ1B41-M	ø12	3/8"	23	6	24	9	18	21	43	—	29	—	9.4
LQ1B42-M	ø10	3/8"	—	—	—	—	—	—	—	—	28	10	7.4
LQ1B43-M	ø12	1/2"	24.5	—	—	—	—	—	—	—	32	—	9.4
LQ1B44-M	ø10	1/2"	—	—	—	—	—	—	—	—	—	—	7.4
* LQ1B45-M	ø8	1/2"	21.5	—	20	—	—	17	34	29.5	23	8	5.5
LQ1B49-M	ø12	1/4"	27.5	7	29	14	28	26	54	33.5	39	6	6
LQ1B51-M	ø19	1/2"	30.5	—	—	—	—	—	—	—	38	—	10
LQ1B52-M	ø12	1/2"	—	—	—	—	—	—	—	—	—	10	9.4
LQ1B53-M	ø19	3/4"	30	7	29	14	28	26	54	39	39	16	15
LQ1B54-M	ø12	3/4"	—	—	—	—	—	—	—	—	—	16	9.4
LQ1B58-M	ø19	1/4"	27.5	—	—	—	—	—	—	—	33.5	6	6
LQ1B59-M	ø19	3/8"	29	—	—	—	—	—	—	—	35	10	10
LQ1B61-M	ø25	3/4"	36	—	—	—	—	—	—	—	—	—	16
LQ1B62-M	ø19	3/4"	—	—	—	—	—	—	—	—	—	—	15
LQ1B63-M	ø25	1"	35	8	39.5	18	36	36	69.5	45	49	—	21.2
LQ1B64-M	ø19	1"	—	—	—	—	—	—	—	—	—	—	15
LQ1B66-M	ø25	1/2"	37	—	—	—	—	—	—	—	—	—	10

Note) Products marked "*" are produced upon receipt of order.
(The body of the fitting is PTFE machined.)

Inch sizes

Model	Applicable tubing O.D.	Connection threads R/NPT	A	B	E	F	G	H	L ₁	L ₂	M	N	Min. port size
LQ1B1A-M	1/8"	1/8"	12	2	10	4	8	—	18.5	15.5	11.5	2	1.8
LQ1B2A-M	1/4"	1/4"	—	—	—	—	—	—	—	—	—	—	3.6
LQ1B2B-M	3/16"	1/8"	—	—	—	—	—	—	—	19.5	—	—	2.9
LQ1B2C-M	1/8"	1/8"	16	4	15	6	12	14	28	—	16.5	4.4	1.8
LQ1B2D-M	1/4"	1/4"	—	—	—	—	—	—	—	—	—	—	3.6
LQ1B2E-M	3/16"	1/4"	—	—	—	—	—	—	—	22	—	—	2.9
LQ1B2F-M	1/8"	1/8"	—	—	—	—	—	—	—	—	—	—	1.8
LQ1B3A-M	3/8"	3/8"	19	—	—	—	—	—	—	25	—	—	5.8
LQ1B3B-M	1/4"	1/4"	—	—	—	—	—	—	—	—	—	—	3.6
LQ1B3C-M	3/8"	3/8"	21	5	20	9	18	—	36.5	—	23	8	5.8
LQ1B3D-M	1/4"	3/8"	—	—	—	—	—	—	—	27	—	—	3.6
* LQ1B3F-M	3/8"	1/8"	18.4	—	—	—	—	—	29	21.9	—	4.4	4.4
LQ1B4A-M	1/2"	1/2"	23	6	24	9	18	21	43	—	29	—	9
LQ1B4B-M	3/8"	3/8"	—	—	—	—	—	—	—	—	—	—	5.8
LQ1B4C-M	1/2"	1/2"	24.5	—	—	—	—	—	—	—	32	10	9
LQ1B4D-M	3/8"	3/8"	—	—	—	—	—	—	—	—	—	—	5.8
LQ1B4G-M	1/2"	1/4"	27.5	7	29	14	28	26	54	33.5	39	6	6
LQ1B5A-M	3/4"	3/4"	30.5	—	—	—	—	—	—	—	38	—	10
LQ1B5B-M	1/2"	1/2"	—	—	—	—	—	—	—	—	—	—	9
LQ1B5C-M	3/4"	3/4"	30	7	29	14	28	26	54	39	39	16	15
LQ1B5D-M	1/2"	3/4"	—	—	—	—	—	—	—	—	—	—	9
LQ1B5G-M	3/4"	1/4"	27.5	—	—	—	—	—	—	—	33.5	6	6
LQ1B5H-M	3/4"	3/8"	29	—	—	—	—	—	—	—	35	10	10
LQ1B6A-M	1"	3/4"	36	—	—	—	—	—	—	—	—	—	16
LQ1B6B-M	3/4"	3/4"	—	—	—	—	—	—	—	—	—	—	15
LQ1B6C-M	1"	1"	35	8	39.5	18	36	36	69.5	45	49	—	21.2
LQ1B6D-M	3/4"	3/4"	—	—	—	—	—	—	—	—	—	—	15
LQ1B6F-M	1"	3/7"	37	—	—	—	—	—	—	—	—	—	10

Note) Products marked "*" are produced upon receipt of order.
(The body of the fitting is PTFE machined.)

LVC
LVA
LVH
LVD
LVQ
LVP
LVV
LQ1
LQ3
LVN
LQHB
TL TIL
TLM TILM
TD TID
TH TIH

LQ1 Series

Dimensions

Female Branch Tee: LQ1B-F



Class 1

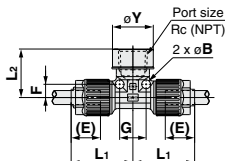

Class 2 to 5

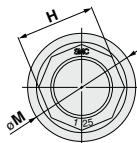

Class 6

(E) shows the approximate dimension of the inserted tubing from the end of the nut.

Metric sizes

Model	Applicable tubing O.D.	Connection threads Rc/NPT	B	E	F	G	H	L ₁	L ₂	M	Min. port size	Y	
LQ1B11-F	ø4	1/8"	2	10	4	8	—	18.5	16	11.5	2.6	18.5	
LQ1B12-F	ø3										1.8		
LQ1B21-F	ø6										3.6		
LQ1B22-F	ø4	1/8"							19.5		2.6	18.5	
LQ1B2C-F	ø3		4	15	6	12				16.5	1.8		
LQ1B23-F	ø6						14	28			3.6		
LQ1B24-F	ø4	1/4"							22		2.6	21.5	
LQ1B2F-F	ø3										1.8		
LQ1B31-F	ø10										7.4		
LQ1B32-F	ø8	1/4"						23.7			5.5	21.5	
LQ1B33-F	ø6										3.6		
LQ1B34-F	ø10		5		9	18		36.5		23	7.4		
LQ1B35-F	ø8	3/8"							25.5		5.5	25	
LQ1B36-F	ø6										3.6		
* LQ1B39-F	ø10										7.4		
* LQ1B310-F	ø8	1/8"	—		—	—		32.3	18.7		5.5	18.5	
LQ1B41-F	ø12	3/8"							25		9.4	25	
LQ1B42-F	ø10		6	24	9	18	21	43		28	7.4		
LQ1B43-F	ø12										9.4	29.5	
LQ1B44-F	ø10	1/2"							31.5		7.4		
* LQ1B49-F	ø12	1/4"	—	29	—	—	—	26	44.3	27.5	39	9.4	21.5
LQ1B51-F	ø19										10		
LQ1B52-F	ø12	1/2"							35.5		9.4	29.5	
LQ1B53-F	ø19		7		14	28		54			15		
LQ1B54-F	ø12	3/4"		29			26		37	39	9.4	36	
* LQ1B58-F	ø19	1/4"	—						44.3	27.5	10.9	21.5	
* LQ1B59-F	ø19	3/8"	—						46	29.5	14.3	25	
LQ1B61-F	ø25										16	36	
LQ1B62-F	ø19	3/4"							42.5		15		
LQ1B63-F	ø25		8	39.5	18	36	36	69.5		49	21.2	44.5	
LQ1B64-F	ø19								46		15		
LQ1B66-F	ø25	1/2"							41		10	29.5	

Note) Products marked "*" are produced upon receipt of order.
(The body of the fitting is PTFE machined.)

Inch sizes

Model	Applicable tubing O.D.	Connection threads Rc/NPT	B	E	F	G	H	L ₁	L ₂	M	Min. port size	Y	
LQ1B1A-F	1/8"	1/8"	2	10	4	8	—	18.5	16	11.5	1.8	18.5	
LQ1B2A-F	1/4"										3.6		
LQ1B2B-F	3/16"	1/8"							19.5		2.9	18.5	
LQ1B2C-F	1/8"		4	15	6	12	14	28		16.5	1.8		
LQ1B2D-F	1/4"										3.6		
LQ1B2E-F	3/16"	1/4"							22		2.9	21.5	
LQ1B2F-F	1/8"										1.8		
LQ1B3A-F	3/8"										5.8		
LQ1B3B-F	1/4"	1/4"							23.7		3.6	21.5	
LQ1B3C-F	3/8"										5.5	25	
LQ1B3D-F	1/4"	3/8"	5		9	18		36.5		23	3.6		
* LQ1B3F-F	3/8"	1/8"	—		—	—		32.3	18.7		5.8	18.5	
LQ1B4A-F	1/2"										9	25	
LQ1B4B-F	3/8"								25		5.8		
LQ1B4C-F	1/2"		6	24	9	18	21	43		28	9		
LQ1B4D-F	3/8"	1/2"							31.5		5.8	29.5	
* LQ1B4G-F	1/2"	1/4"	—	29	—	—	—	26	44.3	27.5	39	9	21.5
LQ1B5A-F	3/4"										10	29.5	
LQ1B5B-F	1/2"	1/2"							35.5		9		
LQ1B5C-F	3/4"		7		14	28		54			15		
LQ1B5D-F	1/2"	3/4"		29			26		37	39	9	36	
* LQ1B5G-F	3/4"	1/4"	—						44.3	27.5	10.9	21.5	
* LQ1B5H-F	1"	3/8"	—						46	29.5	14.3	25	
LQ1B6A-F	1"										16	36	
LQ1B6B-F	3/4"	3/4"							42.5		15		
LQ1B6C-F	1"										21.2	44.5	
LQ1B6D-F	3/4"	1"	8	39.5	18	36	36	69.5		46	15		
LQ1B6F-F	1"	1/2"							41		10	29.5	

Note) Products marked "*" are produced upon receipt of order.
(The body of the fitting is PTFE machined.)

Union Elbow: LQ1E

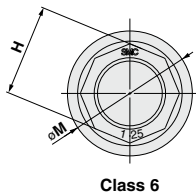
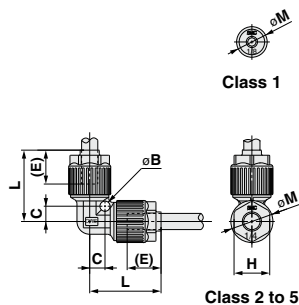

(E) shows the approximate dimension of the inserted tubing from the end of the nut.

Metric sizes

Model	Applicable tubing O.D.	B	C	E	H	L	M	Min. port size
LQ1E11	ø4	2	4	10	—	18.5	11.5	2.6
LQ1E12	ø3							1.8
LQ1E21□□	ø6	4	6	15	14	28	16.5	3.6
LQ1E22□□	ø4							2.6
LQ1E2C□□	ø3							1.8
LQ1E31□□	ø10	5	9	20	17	36.5	23	7.4
LQ1E32□□	ø8							5.5
LQ1E33□□	ø6							3.6
LQ1E41□□	ø12	6	9	24	21	43	28	9.4
LQ1E42□□	ø10							7.4
LQ1E51□□	ø19	7	14	29	26	54	39	15
LQ1E52□□	ø12							9.4
LQ1E61□□	ø25	8	18	39.5	36	69.5	49	21.2
LQ1E62□□	ø19							15

Inch sizes

Model	Applicable tubing O.D.	B	C	E	H	L	M	Min. port size
LQ1E1A	1/8"	2	4	10	—	18.5	11.5	1.8
LQ1E2A□□	1/4"							3.6
LQ1E2B□□	3/16"	4	6	15	14	28	16.5	2.9
LQ1E2C□□	1/8"							1.8
LQ1E3A□□	3/8"	5	9	20	17	36.5	23	5.8
LQ1E3B□□	1/4"							3.6
LQ1E4A□□	1/2"	6	9	24	21	43	28	9
LQ1E4B□□	3/8"							5.8
LQ1E5A□□	3/4"	7	14	29	26	54	39	15
LQ1E5B□□	1/2"							9
LQ1E6A□□	1"	8	18	39.5	36	69.5	49	21.2
LQ1E6B□□	3/4"							15

LVC

LVA

LVB

LVD

LVQ

LVP

LVV

LQ1

LQ3

LVN

LQHB

TL

TIL

TLM

TILM

TD

TID

TH

TIH

LQ1 Series

Dimensions

Union Tee: LQ1T



Class 1

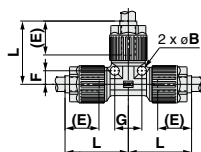

Class 2 to 5

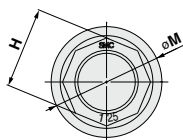

Class 6

(E) shows the approximate dimension of the inserted tubing from the end of the nut.

Metric sizes

Model	Applicable tubing O.D.	B	E	F	G	H	L	M	Min. port size
LQ1T11	ø4	2	10	4	8	—	18.5	11.5	2.6
LQ1T12	ø3								1.8
LQ1T21□□	ø6	4	15	6	12	14	28	16.5	3.6
LQ1T22□□	ø4								2.6
LQ1T2C□□	ø3								1.8
LQ1T31□□	ø10	5	20	9	18	17	36.5	23	7.4
LQ1T32□□	ø8								5.5
LQ1T33□□	ø6								3.6
LQ1T41□□	ø12	6	24	9	18	21	43	28	9.4
LQ1T42□□	ø10								7.4
LQ1T51□□	ø19	7	29	14	28	26	54	39	15
LQ1T52□□	ø12								9.4
LQ1T61□□	ø25	8	39.5	18	36	36	69.5	49	21.2
LQ1T62□□	ø19								15

Inch sizes

Model	Applicable tubing O.D.	B	E	F	G	H	L	M	Min. port size
LQ1T1A	1/8"	2	10	4	8	—	18.5	11.5	1.8
LQ1T2A□□	1/4"								3.6
LQ1T2B□□	3/16"	4	15	6	12	14	28	16.5	2.9
LQ1T2C□□	1/8"								1.8
LQ1T3A□□	3/8"	5	20	9	18	17	36.5	23	5.8
LQ1T3B□□	1/4"								3.6
LQ1T4A□□	1/2"	6	24	9	18	21	43	28	9
LQ1T4B□□	3/8"								5.8
LQ1T5A□□	3/4"	7	29	14	28	26	54	39	15
LQ1T5B□□	1/2"								9
LQ1T6A□□	1"	8	39.5	18	36	36	69.5	49	21.2
LQ1T6B□□	3/4"								15

Panel Mount Union: LQ1P

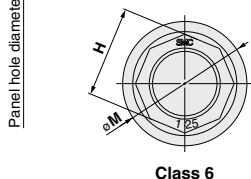
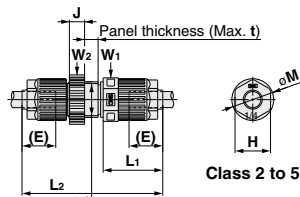

(E) shows the approximate dimension of the inserted tubing from the end of the nut.
"W" is width across flats dimension.

Metric sizes

Model	Applicable tubing O.D.	E	H	J	K	L ₁	L ₂	M	Min. port size	t	W ₁	W ₂
LQ1P11	ø4	10	—	6	10.5	17	44	11.5	2.6	8	11	13
LQ1P12	ø3								1.8			
LQ1P21□□	ø6	15	14	6	14.5	23.5	55.5	16.5	3.6	8	15	17
LQ1P22□□	ø4								2.6			
LQ1P2C□□	ø3	20	17	7	20.5	30	69	23	1.8	8	21	24
LQ1P31□□	ø10								7.4			
LQ1P32□□	ø8	24	21	7	24.5	35	78.5	28	5.5	8	26	28
LQ1P33□□	ø6								3.6			
LQ1P41□□	ø12	29	26	9	36.5	43.5	100	39	9.4	9	39	43
LQ1P42□□	ø10								7.4			
LQ1P51□□	ø19	39.5	36	10	48.5	58.5	133	49	15	10	51	55
LQ1P52□□	ø12								9.4			
LQ1P61□□	ø25	39.5	36	10	48.5	58.5	133	49	21.2	10	51	55
LQ1P62□□	ø19								15			

Inch sizes

Model	Applicable tubing O.D.	E	H	J	K	L ₁	L ₂	M	Min. port size	t	W ₁	W ₂
LQ1P1A	1/8"	10	—	6	10.5	17	44	11.5	1.8	8	11	13
LQ1P2A□□	1/4"								3.6			
LQ1P2B□□	3/16"	15	14	6	14.5	23.5	55.5	16.5	2.9	8	15	17
LQ1P2C□□	1/8"								1.8			
LQ1P3A□□	3/8"	20	17	7	20.5	30	69	23	5.8	8	21	24
LQ1P3B□□	1/4"								3.6			
LQ1P4A□□	1/2"	24	21	7	24.5	35	78.5	28	9	8	26	28
LQ1P4B□□	3/8"								5.8			
LQ1P5A□□	3/4"	29	26	9	36.5	43.5	100	39	15	9	39	43
LQ1P5B□□	1/2"								9			
LQ1P6A□□	1"	39.5	36	10	48.5	58.5	133	49	21.2	10	51	55
LQ1P6B□□	3/4"								15			

LVC

LVA

LVH

LVD

LVQ

LVP

LWV

LQ1

LQ3

LVN

LQHB

TL

TIL

TLM

TILM

TD

TID

TH

TIH

LQ1 Series

Dimensions

Union: LQ1U

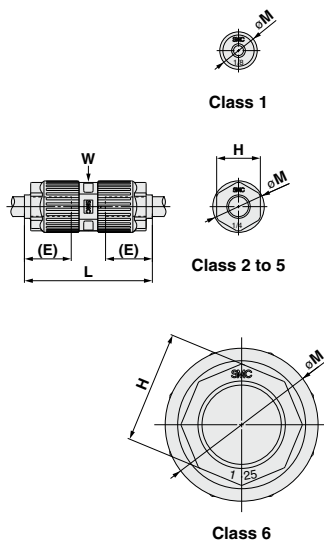

(E) shows the approximate dimension of the inserted tubing from the end of the nut.
"W" is width across flats dimension.

Union Flange: LQ1F

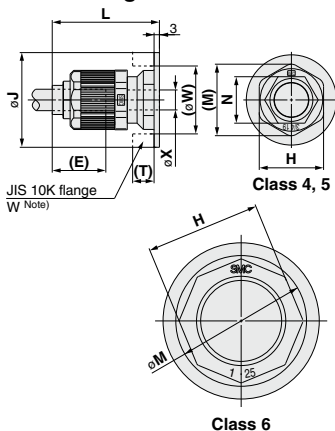

(E) shows the approximate dimension of the inserted tubing from the end of the nut.
(W) is the bore size of the JIS flange required for mounting. This flange is sold separately.
When ordering nuts as spare parts, size 4 and 5 are as shown below.

LQ1F4□: LQ-4N□□
LQ1F5□: LQ-5N□□

Metric sizes

Model	Applicable tubing O.D.	E	H	L	M	Min. port size	W
LQ1U11	ø4	10	—	29	11.5	2.6	10
LQ1U12	ø3					1.8	
LQ1U21□□	ø6					3.6	
LQ1U22□□	ø4	15	14	41	16.5	2.6	14
LQ1U2C□□	ø3					1.8	
LQ1U31□□	ø10					7.4	
LQ1U32□□	ø8	20	17	54	23	5.5	19
LQ1U33□□	ø6					3.6	
LQ1U41□□	ø12					9.4	
LQ1U42□□	ø10	24	21	63	28	7.4	23
LQ1U51□□	ø19					15	
LQ1U52□□	ø12					9.4	
LQ1U61□□	ø25	39.5	36	102	49	21.2	46
LQ1U62□□	ø19					15	

Inch sizes

Model	Applicable tubing O.D.	E	H	L	M	Min. port size	W
LQ1U1A	1/8"	10	—	29	11.5	1.8	10
LQ1U2A□□	1/4"					3.6	
LQ1U2B□□	3/16"	15	14	41	16.5	2.9	14
LQ1U2C□□	1/8"					1.8	
LQ1U3A□□	3/8"					5.8	
LQ1U3B□□	1/4"	20	17	54	23	3.6	19
LQ1U4A□□	1/2"					9	
LQ1U4B□□	3/8"					5.8	
LQ1U5A□□	3/4"	29	26	77	39	15	32
LQ1U5B□□	1/2"					9	
LQ1U6A□□	1"					21.2	
LQ1U6B□□	3/4"	39.5	36	102	49	15	46

Metric sizes

Model	Applicable tubing O.D.	E	H	J	L	N	M	W	(T)	X	Min. port size
LQ1F41	ø12	28	30	53	60	21	33.1	34	12	10	9.4
LQ1F42	ø10				58						7.4
LQ1F51	ø19	32	36	58	65.2	26	40	41	14	16	15
LQ1F52	ø12				63.2						9.4
LQ1F61	ø25				21.2						
LQ1F62	ø19	39.5	36	69	81.5	—	49	51	14	22.5	15

Inch sizes

Model	Applicable tubing O.D.	E	H	J	L	N	M	W	(T)	X	Min. port size
LQ1F4A	1/2"	28	30	53	60	21	33.1	34	12	10	9
LQ1F4B	3/8"				58						5.8
LQ1F5A	3/4"	32	36	58	65.2	26	40	41	14	16	15
LQ1F5B	1/2"				63.2						9
LQ1F6A	1"				21.2						
LQ1F6B	3/4"	39.5	36	69	81.5	—	49	51	14	22.5	15

Union Elbow Reducing

How to Order

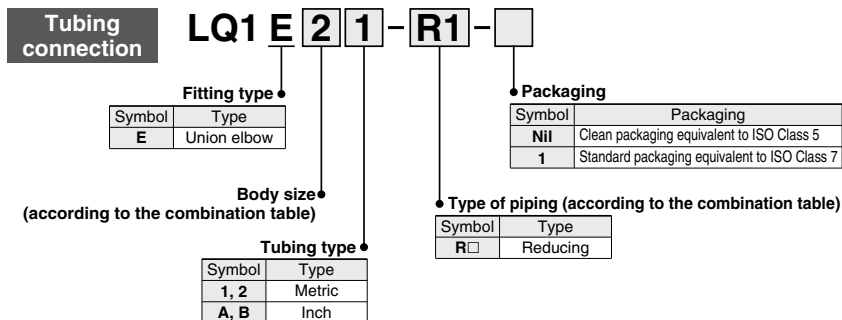

Size combination (Metric)

Class	Model	A side	B side
		Applicable tubing size (mm)	
4	LQ1E41-R2	12 x 10	8 x 6
	* LQ1E41-R3		6 x 4
	* LQ1E41-R4		4 x 2
5	* LQ1E51-R2	19 x 16	10 x 8
	* LQ1E51-R3		8 x 6
	* LQ1E51-R4		6 x 4
	* LQ1E51-R5		4 x 3
6	* LQ1E61-R2	25 x 22	12 x 10
	* LQ1E61-R3		10 x 8
	* LQ1E61-R4		8 x 6
	* LQ1E61-R5		6 x 4

Note 1) Products marked "*" are produced upon receipt of order.
(The body of the fitting is PTFE machined.)

Note 2) For details of the applicable tubing sizes, refer to page 945.

Size combination (Inch)

Class	Model	A side	B side
		Applicable tubing size (inch)	
3	* LQ1E3A-R3	3/8" x 1/4"	1/8" x 0.086"
	LQ1E4A-R2		1/4" x 5/32"
4	* LQ1E4A-R2	1/2" x 3/8"	3/16" x 0.127"
	* LQ1E4A-R4		1/8" x 0.086"
5	* LQ1E5A-R2	3/4" x 5/8"	3/8" x 1/4"
	* LQ1E5A-R3		1/4" x 5/32"
	* LQ1E5A-R4		3/16" x 0.127"
6	* LQ1E6A-R2	1" x 7/8"	1/2" x 3/8"
	* LQ1E6A-R3		3/8" x 1/4"
	* LQ1E6A-R4		1/4" x 5/32"
	* LQ1E6A-R5		3/16" x 0.127"

Note 1) Products marked "*" are produced upon receipt of order.
(The body of the fitting is PTFE machined.)

Note 2) For details of the applicable tubing sizes, refer to page 945.

LVC

LVA

LVH

LVD

LVQ

LVP

LVW

LQ1

LQ3

LVN

LQHB

TL

TIL

TLM

TILM

TD

TID

TH

TIH

LQ1 Series

Dimensions

Union Elbow Reducing: LQ1E-R

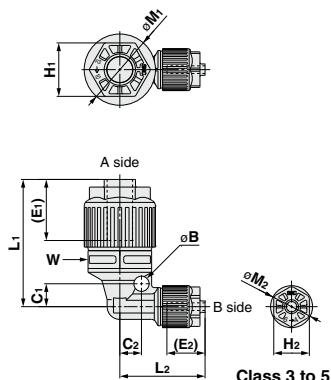

Class 6

Metric Size

Model	Applicable tubing O.D.		B	C ₁	C ₂	E ₁	E ₂	H ₁	H ₂	L ₁	L ₂	M ₁	M ₂	Min. port size	W
	A side	B side													
LQ1E41-R2	ø12	ø8	6	9	9		20		17	43	38.5		23	5.5	—
* LQ1E41-R3	ø12	ø6				24	15	21	14	35.5	31.5	28	16.5	3.6	25
* LQ1E41-R4	ø12	ø4												2.6	
* LQ1E51-R2	ø19	ø10				39.5	20	36	17	56.5	52.5	49	23	7.4	46
* LQ1E51-R3	ø19	ø8							54	47.5				5.5	
* LQ1E51-R4	ø19	ø6												3.6	
* LQ1E51-R5	ø19	ø4				39.5	15	36	14	51	42	39	16.5	2.6	
* LQ1E61-R2	ø25	ø12					24		21	56.5	52.5		28	9.4	
* LQ1E61-R3	ø25	ø10				39.5	20	36	17	54	47.5	49	23	7.4	46
* LQ1E61-R4	ø25	ø8												5.5	
* LQ1E61-R5	ø25	ø6					15		15	51	42		16.5	3.6	

Note) Products marked "*" are produced upon receipt of order.
(The body of the fitting is PTFE machined.)

Inch Size

Model	Applicable tubing O.D.		B	C ₁	C ₂	E ₁	E ₂	H ₁	H ₂	L ₁	L ₂	M ₁	M ₂	Min. port size	W
	A side	B side													
* LQ1E3A-R3	3/8"	1/8"	—	—	—	24	15	21	14	35.5	31.5	28	16.5	1.8	—
LQ1E4A-R2	1/2"	1/4"	6	9	9		20		17	43	38.5		23	3.6	—
* LQ1E4A-R3	1/2"	3/16"				24	15	21	14	35.5	31.5	28	16.5	2.9	—
* LQ1E4A-R4	1/2"	1/8"												1.8	
* LQ1E5A-R2	3/4"	3/8"				39.5	20	36	17	54	47.5	49	23	5.8	46
* LQ1E5A-R3	3/4"	1/4"							15	51	42			3.6	
* LQ1E5A-R4	3/4"	3/16"												2.9	
* LQ1E6A-R2	1"	1/2"					24		21	56.5	52.5		28	9	
* LQ1E6A-R3	1"	3/8"				39.5	20	36	17	54	47.5	49	23	5.8	46
* LQ1E6A-R4	1"	1/4"												3.6	
* LQ1E6A-R5	1"	3/16"					15		14	51	42		16.5	2.9	

Note) Products marked "*" are produced upon receipt of order.
(The body of the fitting is PTFE machined.)

LQ1 Series

Union Tee Reducing

How to Order

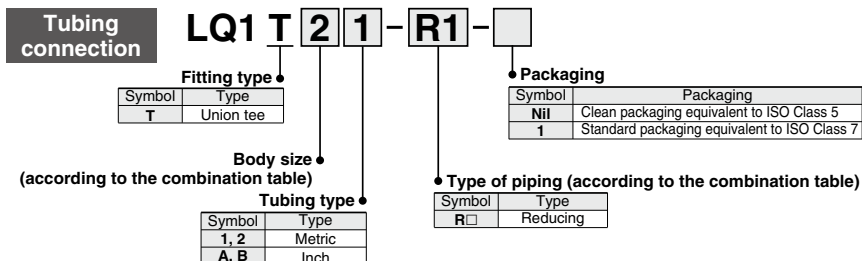

Size combination (Metric)

Class	Model	Applicable tubing size (mm)			
		A side (Left)	B side (Center)	C side (Right)	
3	LQ1T31-R4	10 x 8	3 x 2	10 x 8	
	LQ1T31-R7	8 x 6	8 x 6	10 x 8	
	LQ1T31-R8	6 x 4	6 x 4	10 x 8	
	LQ1T32-R5		8 x 6	8 x 6	
	LQ1T32-R6		10 x 8	10 x 8	
	LQ1T32-R7		6 x 4	8 x 6	
	4	LQ1T41-R2	12 x 10	8 x 6	12 x 10
LQ1T41-R3		6 x 4		12 x 10	
LQ1T41-R5		10 x 8	12 x 10	12 x 10	
LQ1T41-R7			10 x 8	12 x 10	
LQ1T41-R11		6 x 4	10 x 8	12 x 10	
LQ1T41-R12			12 x 10	12 x 10	
LQ1T41-R22		10 x 8	6 x 4	12 x 10	
LQ1T41-R23		6 x 4	6 x 4	12 x 10	
LQ1T41-R26		12 x 10	3 x 2	12 x 10	
LQ1T41-R32		6 x 4	12 x 10	6 x 4	
LQ1T41-R34		3 x 2	12 x 10	3 x 2	
5		LQ1T51-R2	19 x 16	10 x 8	19 x 16
		LQ1T51-R3		8 x 6	19 x 16
	LQ1T51-R4	6 x 4		19 x 16	
	LQ1T51-R5	12 x 10	19 x 16	19 x 16	
	LQ1T51-R6	10 x 8	19 x 16	19 x 16	
	* LQ1T51-R7	12 x 10	12 x 10	19 x 16	
	* LQ1T51-R8	10 x 8	10 x 8	19 x 16	
	LQ1T51-R10	10 x 8	19 x 16	10 x 8	
	LQ1T51-R12	8 x 6	19 x 16	19 x 16	
	LQ1T51-R13	6 x 4	19 x 16	19 x 16	
	* LQ1T51-R17	10 x 8	12 x 10	19 x 16	
	LQ1T51-R24	12 x 10	6 x 4	19 x 16	
	LQ1T51-R26	19 x 16	4 x 3	19 x 16	
	LQ1T51-R28		3 x 2	19 x 16	
	LQ1T51-R31		10 x 8	19 x 16	12 x 10
	6	LQ1T61-R2	25 x 22	12 x 10	25 x 22
		LQ1T61-R3		10 x 8	25 x 22
* LQ1T61-R4		8 x 6		25 x 22	
LQ1T61-R5		19 x 16	25 x 22	25 x 22	
LQ1T61-R6		12 x 10	25 x 22	25 x 22	
LQ1T61-R7		19 x 16	19 x 16	25 x 22	
* LQ1T61-R8		12 x 10	12 x 10	25 x 22	
LQ1T61-R10		12 x 10	25 x 22	12 x 10	
LQ1T61-R11			19 x 16	25 x 22	
LQ1T61-R12		10 x 8	25 x 22	25 x 22	
* LQ1T61-R13		8 x 6	25 x 22	25 x 22	
LQ1T61-R15		6 x 4	25 x 22	25 x 22	
LQ1T61-R18		10 x 8	19 x 16	25 x 22	
LQ1T61-R19		6 x 4	19 x 16	25 x 22	
LQ1T61-R20		19 x 16	12 x 10	25 x 22	
* LQ1T61-R26		25 x 22	6 x 4	25 x 22	
LQ1T61-R30		10 x 8	25 x 22	19 x 16	
LQ1T61-R31		12 x 10	25 x 22	19 x 16	
* LQ1T61-R34		6 x 4	25 x 22	6 x 4	

Note 1) Products marked "*" are produced upon receipt of order.
(The body of the fitting is PTFE machined.)

Note 2) For details of the applicable tubing sizes, refer to page 945.

Size combination (Inch)

Class	Model	Applicable tubing size (inch)		
		A side (Left)	B side (Center)	C side (Right)
3	LQ1T3A-R5	1/4" x 5/32"	3/8" x 1/4"	3/8" x 1/4"
	LQ1T3A-R7	1/4" x 5/32"	1/4" x 5/32"	3/8" x 1/4"
	LQ1T4A-R2	1/2" x 3/8"	1/4" x 5/32"	1/2" x 3/8"
	LQ1T4A-R4	1/2" x 3/8"	1/8" x 0.086"	1/2" x 3/8"
	LQ1T4A-R5	3/8" x 1/4"	1/2" x 3/8"	1/2" x 3/8"
	LQ1T4A-R6	1/4" x 5/32"		1/2" x 3/8"
	LQ1T4A-R7	3/8" x 1/4"	3/8" x 1/4"	1/2" x 3/8"
4	LQ1T4A-R8	1/4" x 5/32"	1/4" x 5/32"	1/2" x 3/8"
	LQ1T4A-R10	1/4" x 5/32"	1/2" x 3/8"	1/4" x 5/32"
	LQ1T4A-R17	1/4" x 5/32"	3/8" x 1/4"	1/2" x 3/8"
	LQ1T4A-R20	3/8" x 1/4"	1/4" x 5/32"	1/2" x 3/8"
	LQ1T4A-R33	1/8" x 0.086"	1/2" x 3/8"	1/8" x 0.086"
	LQ1T5A-R2	3/4" x 5/8"	3/8" x 1/4"	3/4" x 5/8"
	LQ1T5A-R5	1/2" x 3/8"	3/4" x 5/8"	3/4" x 5/8"
	LQ1T5A-R6	3/8" x 1/4"	3/4" x 5/8"	3/4" x 5/8"
	* LQ1T5A-R7	1/2" x 3/8"	3/4" x 3/8"	3/4" x 5/8"
	LQ1T5A-R8	3/8" x 1/4"	3/8" x 1/4"	3/4" x 5/8"
	* LQ1T5A-R10	3/8" x 1/4"	3/4" x 5/8"	3/8" x 1/4"
	LQ1T5A-R12	1/4" x 5/32"		3/4" x 5/8"
	* LQ1T5A-R17	1/2" x 3/8"	3/8" x 1/4"	3/4" x 5/8"
	LQ1T5A-R21	3/8" x 1/4"	1/4" x 5/32"	3/4" x 5/8"
	LQ1T5A-R22	1/2" x 3/8"	1/4" x 5/32"	3/4" x 5/8"
	LQ1T5A-R26	3/4" x 5/8"	1/8" x 0.086"	3/4" x 5/8"
	LQ1T5A-R31	3/8" x 1/4"	3/4" x 5/8"	3/4" x 3/8"
* LQ1T5A-R32	1/4" x 5/32"	1/4" x 5/32"		
5	LQ1T6A-R2	1" x 7/8"	1/2" x 3/8"	1" x 7/8"
	LQ1T6A-R3	1" x 7/8"	3/8" x 1/4"	1" x 7/8"
	* LQ1T6A-R4	1" x 7/8"	1/4" x 5/32"	1" x 7/8"
	LQ1T6A-R5	3/4" x 5/8"	1" x 7/8"	1" x 7/8"
	LQ1T6A-R6	1/2" x 3/8"		1" x 7/8"
	LQ1T6A-R7	3/4" x 5/8"	3/4" x 5/8"	1" x 7/8"
	* LQ1T6A-R8	1/2" x 3/8"	1/2" x 3/8"	1" x 7/8"
	LQ1T6A-R10	1/2" x 3/8"	1" x 7/8"	1/2" x 3/8"
	LQ1T6A-R11	3/8" x 1/4"	3/4" x 5/8"	1" x 7/8"
	LQ1T6A-R12	3/8" x 1/4"	1" x 7/8"	1" x 7/8"
	* LQ1T6A-R13	1/4" x 5/32"		1" x 7/8"
	LQ1T6A-R17	1/2" x 3/8"	3/4" x 5/8"	1" x 7/8"
	* LQ1T6A-R18	1/4" x 5/32"		1" x 7/8"
LQ1T6A-R20	3/4" x 5/8"	1/2" x 3/8"	1" x 7/8"	
LQ1T6A-R30	3/8" x 1/4"	1" x 7/8"	3/4" x 5/8"	
LQ1T6A-R31	1/2" x 3/8"		3/4" x 5/8"	
* LQ1T6A-R33	1/4" x 5/32"	1/4" x 5/32"	1" x 7/8"	

Note 1) Products marked "*" are produced upon receipt of order.
(The body of the fitting is PTFE machined.)

Note 2) For details of the applicable tubing sizes, refer to page 945.

LVC

LVA

LVH

LVD

LVQ

LVP

LVW

LQ1

LQ3

LVN

LQHB

TL

TIL

TLM

TD

TH

THH

LQ1 Series

Dimensions

Union tee reducing: LQ1T-R

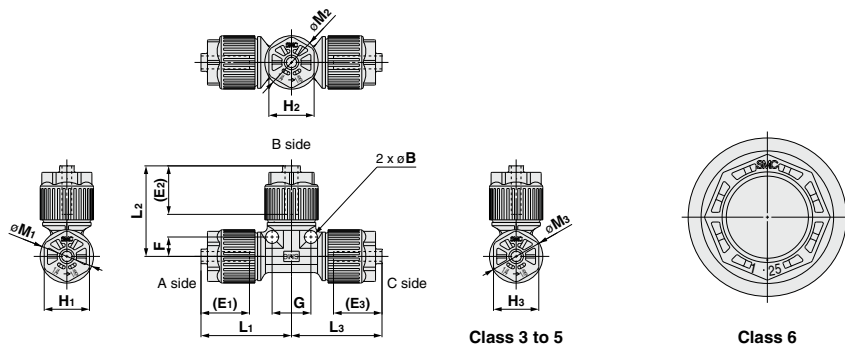

Class 3 to 5

Class 6

Metric Size

Model	A side	B side	C side	B	E ₁	E ₂	E ₃	F	G	H ₁	H ₂	H ₃	L ₁	L ₂	L ₃	M ₁	M ₂	M ₃	Min. port size									
	Applicable tubing O.D.																											
LQ1T31-R4	ø10	ø3	ø10	6	24	15	24	9	18	21	14	21	43	33	43	28	16.5	28	1.8									
LQ1T31-R7	ø8	ø8	ø10	5	20	20	20	9	18	17	17	17	36.5	36.5	36.5	23	23	23	5.5									
LQ1T31-R8	ø6	ø6	ø10																3.6									
LQ1T32-R5	ø6	ø8	ø8																3.6									
LQ1T32-R6	ø6	ø10	ø10	6	24	24	24	9	18	21	17	21	43	38.5	43	28	23	23	3.6									
LQ1T32-R7	ø6	ø6	ø8																3.6									
LQ1T41-R2	ø12	ø8	ø12																20	15	24	9	18	21	17	21	43	38.5
LQ1T41-R3	ø12	ø6	ø12	14	33	16.5	3.6																					
LQ1T41-R5	ø10	ø12	ø12	7	20	29	29	14	28	17	17	26	44	54	54	23	39	39	7.4									
LQ1T41-R7	ø10	ø10	ø12																21	43	28	7.4						
LQ1T41-R11	ø6	ø10	ø12																21	43	28	3.6						
LQ1T41-R12	ø6	ø12	ø12	6	24	20	24	9	18	21	17	26	44	54	54	23	39	39	3.6									
LQ1T41-R22	ø10	ø6	ø12																21	43	28	3.6						
LQ1T41-R23	ø6	ø6	ø12																21	43	28	3.6						
LQ1T41-R26	ø12	ø3	ø12	6	15	24	24	9	18	14	21	14	33	43	33	16.5	28	16.5	1.8									
LQ1T41-R32	ø6	ø12	ø6																14	21	14	33	43	33	16.5	28	16.5	1.8
LQ1T41-R34	ø3	ø12	ø3																14	21	14	33	43	33	16.5	28	16.5	1.8
LQ1T51-R2	ø19	ø10	ø19	7	29	20	29	14	28	26	17	26	54	44	54	39	23	39	7.4									
LQ1T51-R3	ø19	ø8	ø19																5.5									

LVC
LVA
LVH
LVD
LVQ
LVP
LVW
LQ1
LQ3
LVN
LQHB
TL TIL
TLM TILM
TD TID
TH TIH

Metric Size

Model	A side Applicable tubing O.D.	B side	C side	B	E ₁	E ₂	E ₃	F	G	H ₁	H ₂	H ₃	L ₁	L ₂	L ₃	M ₁	M ₂	M ₃	Min. port size			
LQ1T51-R4	ø19	ø6	ø19	7	29	15	29	14	28	26	14	26	54	38.5	54	39	16.5	39	3.6			
LQ1T51-R5	ø12	ø19	ø19		29	29					26		44	54		23	39		9.4			
LQ1T51-R6	ø10	ø19	ø19		20	29	24			17	44	23	39	7.4								
* LQ1T51-R7	ø12	ø12	ø19	—	24	24	39.5	—	—	21	21	36	42	52.5	57.5	28	28	49	9.4			
* LQ1T51-R8	ø10	ø10	ø19		20	29	24			17	26	21	36	42	52.5	57.5	28	28	49	7.4		
LQ1T51-R10	ø10	ø19	ø10	7	20	29	24	14	28	17	26	21	44	54	54	23	39	39	7.4			
LQ1T51-R12	ø8	ø19	ø19		20	29	29			17	26	26							44	54	54	23
LQ1T51-R13	ø6	ø19	ø19		20	29	24			17	26	26	44	54	54	23	39	39	3.6			
* LQ1T51-R17	ø10	ø12	ø19	—	24	24	39.5	18	36	21	21	36	42	52.5	57.5	28	28	49	7.4			
LQ1T51-R24	ø12	ø6	ø19		24	24	39.5	18	36	21	21	36	42	52.5	57.5	28	28	49	3.6			
LQ1T51-R26	ø19	ø4	ø19	7	29	15	29	14	28	26	14	26	54	38.5	54	39	16.5	39	2.6			
LQ1T51-R28	ø19	ø3	ø19		20	29	24			17	26	21	44	54	49	23	39	28	1.8			
LQ1T51-R31	ø10	ø19	ø12		20	29	24			17	26	21	44	54	49	23	39	28	7.4			
LQ1T61-R2	ø25	ø12	ø25	8	39.5	24	39.5	18	36	36	21	36	69.5	54.5	69.5	49	28	49	9.4			
LQ1T61-R3	ø25	ø10	ø25			20					—		—	36	17		55	47.5	55	23	49	5.5
* LQ1T61-R4	ø19	ø25	ø25	8	24	39.5	39.5	18	36	21	36	36	69.5	69.5	69.5	28	49	49	15			
LQ1T61-R6	ø12	ø25	ø25										39.5						—	—	36	17
LQ1T61-R7	ø19	ø19	ø25							24	24	—	—	21	21	47	52.5	57.5	28	28	15	
* LQ1T61-R8	ø12	ø12	ø19	—	24	24	—	—	21	21	47	52.5	57.5	28	28	9.4						
LQ1T61-R10	ø12	ø25	ø12	8	24	39.5	24	18	36	21	36	21	54.5	69.5	54.5	28	49	28	9.4			
LQ1T61-R11	ø12	ø19	ø25	8	24	39.5	39.5	18	36	21	36	36	54.5	69.5	68.5	28	49	49	9.4			
LQ1T61-R12	ø10	ø25	ø25										24	—	—	17			36	36	46.5	68
* LQ1T61-R13	ø8	ø25	ø25	—	20	39.5	39.5	—	—	17	36	36	46.5	68	68	23	49	49	5.5			
LQ1T61-R15	ø6	ø25	ø25	8	15	39.5	39.5	18	36	14	36	36	44	69.5	69.5	16.5	28	49	3.6			
LQ1T61-R18	ø10	ø19	ø25		24					—			—						17	36	36	44
LQ1T61-R19	ø6	ø19	ø25	8	15	39.5	39.5	18	36	14	36	36	44	69.5	69.5	16.5	49	49	3.6			
LQ1T61-R20	ø19	ø12	ø25		24	—				—	17		36	36	44	69.5	69.5		16.5	49	49	9.4
* LQ1T61-R26	ø25	ø6	ø25	—	39.5	20	39.5	—	—	36	17	36	55	47.5	55	49	23	49	3.6			
LQ1T61-R30	ø10	ø25	ø19	8	24	39.5	39.5	18	36	21	36	36	54.5	69.5	49.5	28	49	49	7.4			
LQ1T61-R31	ø12	ø25	ø19										20	—	—	17			36	36	44	69.5
* LQ1T61-R34	ø6	ø25	ø6							—	20	—	—	17	36	17	46.5	55	46.5	23	—	23

Note) Products marked "e" are produced upon receipt of order. (The body of the fitting is PTFE machined.)

LQ1 Series

Dimensions

Union tee reducing: LQ1T-R

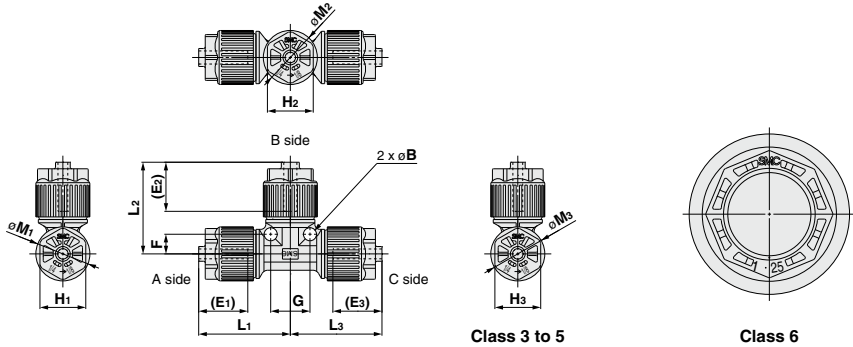

Inch Size

Model	A side Applicable tubing O.D.	B side	C side	B	E ₁	E ₂	E ₃	F	G	H ₁	H ₂	H ₃	L ₁	L ₂	L ₃	M ₁	M ₂	M ₃	Min. port size
LQ1T3A-R5	1/4"	3/8"	3/8"	5	20	20	20	9	18	17	17	17	36.5	36.5	36.5	23	23	23	3.6
LQ1T3A-R7	1/4"	1/4"	3/8"																3.6
LQ1T4A-R2	1/2"	1/4"	1/2"	6	24	15	24	9	18	21	14	21	43	33	43	28	16.5	28	3.6
LQ1T4A-R4	1/2"	1/8"	1/2"																1.8
LQ1T4A-R5	3/8"	1/2"	1/2"	7	20	29	29	14	28	17	26	26	44	54	54	23	39	39	5.8
LQ1T4A-R6	1/4"	1/2"	1/2"																3.6
LQ1T4A-R7	3/8"	3/8"	1/2"	6	24	24	24	9	18	21	21	21	43	43	43	28	28	28	5.8
LQ1T4A-R8	1/4"	1/4"	1/2"																3.6
LQ1T4A-R10	1/4"	1/2"	1/4"	6	15	24	15	9	18	14	21	14	33	43	33	16.5	28	16.5	3.6
LQ1T4A-R17	1/4"	3/8"	1/2"																3.6
LQ1T4A-R20	3/8"	1/4"	1/2"	6	20	24	24	9	18	21	17	21	43	38.5	43	28	23	28	3.6
LQ1T4A-R33	1/8"	1/2"	1/8"																3.6
LQ1T5A-R2	3/4"	3/8"	3/4"	7	29	20	29	14	28	26	17	26	54	44	54	39	23	39	5.8
LQ1T5A-R5	1/2"	3/4"	3/4"																9
LQ1T5A-R6	3/8"	3/4"	3/4"	7	20	29	29	14	28	17	26	26	44	54	54	23	39	39	5.8
* LQ1T5A-R7	1/2"	1/2"	3/4"																9
LQ1T5A-R8	3/8"	3/8"	3/4"	7	20	20	29	14	28	17	17	26	44	44	54	23	23	39	5.8

Note) Products marked "*" are produced upon receipt of order. (The body of the fitting is PTFE machined.)

LVC
LVA
LVH
LVD
LVQ
LVP
LVW
LQ1
LQ3
LVN
LQHB
TL
TIL
TLM
TILM
TD
TID
TH
TIH

Inch Size

Model	A side	B side	C side	B	E ₁	E ₂	E ₃	F	G	H ₁	H ₂	H ₃	L ₁	L ₂	L ₃	M ₁	M ₂	M ₃	Min. port size
	Applicable tubing O.D.																		
* LQ1T5A-R10	3/8"	3/4"	3/8"	—	20	39.5	20	—	—	17	36	17	46.5	55	46.5	23	49	23	5.8
LQ1T5A-R12	1/4"	3/4"	3/4"	7	15	29	29	14	28	14	26	26	38.5	54	54	16.5	39	39	3.6
* LQ1T5A-R17	1/2"	3/8"	3/4"	—	24	24	39.5	—	—	21	21	36	42	52.5	57.5	28	28	49	5.8
LQ1T5A-R21	3/8"	1/4"	3/4"	7	20	20	29	14	28	17	17	26	44	44	54	23	23	39	3.6
LQ1T5A-R22	1/2"	1/4"	3/4"		29	29				24	39		16.5	3.6					
LQ1T5A-R26	3/4"	1/8"	3/4"	7	29	15	29	14	28	26	14	26	54	38.5	54	39	16.5	39	1.8
LQ1T5A-R31	3/8"	3/4"	1/2"		20	29				24	23		49	28		5.8			
* LQ1T5A-R32	1/4"	3/4"	1/4"	—	20	39.5	20	—	—	17	36	17	46.5	55	46.5	23	49	23	3.6
LQ1T6A-R2	1"	1/2"	1"	8	39.5	24	39.5	18	36	36	17	36	69.5	54.5	69.5	49	28	49	9
LQ1T6A-R3	1"	3/8"	1"			24							20	5.8					
* LQ1T6A-R4	1"	1/4"	1"	—	20	39.5	39.5	18	36	21	36	36	55	47.5	55	23	23	49	3.6
LQ1T6A-R5	3/4"	1"	1"	8	24								15						
LQ1T6A-R6	1/2"	1"	1"	8	24	39.5	39.5	18	36	21	36	36	54.5	69.5	69.5	28	49	49	9
LQ1T6A-R7	3/4"	3/4"	1"	8	39.5	15													
* LQ1T6A-R8	1/2"	1/2"	1"	—	24	24	39.5	18	36	21	21	36	42	52.5	57.5	28	28	49	9
LQ1T6A-R10	1/2"	1"	1/2"	8	24	24							21	9					
LQ1T6A-R11	3/8"	3/4"	1"	8	24	39.5	39.5	18	36	21	36	36	54.5	69.5	69.5	28	49	49	5.8
LQ1T6A-R12	3/8"	1"	1"										24	39.5	5.8				
* LQ1T6A-R13	1/4"	1"	1"	—	20	39.5	39.5	18	36	21	36	36	46.5	68	68	23	49	49	3.6
LQ1T6A-R17	1/2"	3/4"	1"	8	24								28	28	9				
* LQ1T6A-R18	1/4"	3/4"	1"	—	20	39.5	39.5	18	36	17	36	36	46.5	68	68	23	49	49	3.6
LQ1T6A-R20	3/4"	1/2"	1"	8	39.5	24							28	28	9				
LQ1T6A-R30	3/8"	1"	3/4"	8	24	39.5	39.5	18	36	21	36	36	69.5	54.5	69.5	49	28	49	5.8
LQ1T6A-R31	1/2"	1"	3/4"										24	39.5		28	49		9
* LQ1T6A-R33	1/4"	1"	1/4"	—	20	20	20	—	—	17	36	17	46.5	55	46.5	23	23	3.6	

Note) Products marked "*" are produced upon receipt of order. (The body of the fitting is PTFE machined.)

Panel Mount Union Reducing

How to Order

Tubing connection

LQ1 P 2 1 - R1 -

Fitting type

Symbol	Type
P	Panel mount union

Body size
(according to the combination table)

Tubing type

Symbol	Type
1, 2	Metric
A, B	Inch

Packaging

Symbol	Packaging
Nil	Clean packaging equivalent to ISO Class 5
1	Standard packaging equivalent to ISO Class 7

Piping type
(according to the combination table)

Symbol	Type
R□	Reducing

Size combination (Metric)

Class	Model	A side	B side
		Applicable tubing size (mm)	
4	* LQ1P41-R3	12 x 10	6 x 4
5	* LQ1P51-R2	19 x 16	10 x 8

Note 1) Products marked "*" are produced upon receipt of order. (The body of the fitting is PTFE machined.)

Note 2) For details of the applicable tubing sizes, refer to page 945.

Size combination (Inch)

Class	Model	A side	B side
		Applicable tubing size (inch)	
4	* LQ1P4A-R2	1/2" x 3/8"	1/4" x 5/32"
5	* LQ1P5A-R2	3/4" x 5/8"	3/8" x 1/4"

Note 1) Products marked "*" are produced upon receipt of order. (The body of the fitting is PTFE machined.)

Note 2) For details of the applicable tubing sizes, refer to page 945.

Dimensions

Panel mount union reducing: LQ1P-R

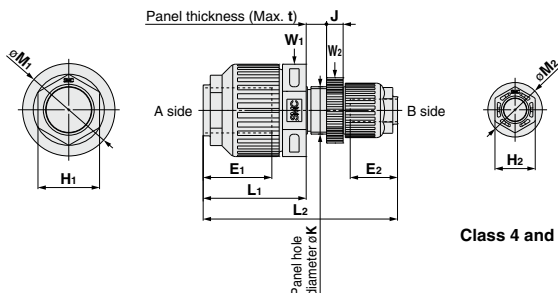

Class 4 and 5

Metric Size

Model	A side	B side	E ₁	E ₂	H ₁	H ₂	J	K	L ₁	L ₂	M ₁	M ₂	Min. port size	t	W ₁	W ₂
	Applicable tubing O.D.															
* LQ1P41-R3	ø12	ø6	29	20	26	17	7	20.5	43.5	82.1	39	23	3.6	8	39	24
* LQ1P51-R2	ø19	ø10	29	20	26	17	7	20.5	43.5	82.1	39	23	7.4	8	39	24

Inch Size

Model	A side	B side	E ₁	E ₂	H ₁	H ₂	J	K	L ₁	L ₂	M ₁	M ₂	Min. port size	t	W ₁	W ₂
	Applicable tubing O.D.															
* LQ1P4A-R2	1/2"	1/4"	29	20	26	17	7	20.5	43.5	82.1	39	23	3.6	8	39	24
* LQ1P5A-R2	3/4"	3/8"	29	20	26	17	7	20.5	43.5	82.1	39	23	5.8	8	39	24

Note) Products marked "*" are produced upon receipt of order. (The body of the fitting is PTFE machined.)

LQ1 Series Union Reducing

How to Order

Tubing connection

LQ1 U 2 1 - R1 -

Symbol	Type
U	Union

Fitting type

Body size
(according to the combination table)

Symbol	Type
1, 2	Metric
A, B	Inch

Tubing type

Piping type
(according to the combination table)

Symbol	Type
R□	Reducing

Packaging

Symbol	Packaging
NH	Clean packaging equivalent to ISO Class 5
1	Standard packaging equivalent to ISO Class 7

Size combination (Metric)

Class	Model	A side	B side
		Applicable tubing size (mm)	
3	LQ1U31-R3	10 x 8	4 x 3
	LQ1U31-R4		3 x 2
4	LQ1U41-R2	12 x 10	8 x 6
	LQ1U41-R3		6 x 4
	LQ1U41-R4		4 x 3
	LQ1U41-R5		3 x 2
	LQ1U51-R2		10 x 8
5	* LQ1U51-R3	19 x 16	8 x 6
	* LQ1U51-R4		6 x 4
	LQ1U51-R5		4 x 3
	LQ1U51-R6		3 x 2
	LQ1U61-R2		12 x 10
	* LQ1U61-R3		10 x 8
6	LQ1U61-R4	25 x 22	6 x 4
	* LQ1U61-R5		6 x 4

Note 1) Products marked "*" are produced upon receipt of order. (The body of the fitting is PTFE machined.)

Note 2) For details of the applicable tubing sizes, refer to page 945.

Size combination (Inch)

Class	Model	A side	B side
		Applicable tubing size (inch)	
4	LQ1U4A-R2	1/2" x 3/8"	1/4" x 5/32"
	LQ1U4A-R3		3/16" x 0.127"
	LQ1U4A-R4		1/8" x 0.086"
5	* LQ1U5A-R2	3/4" x 5/8"	3/8" x 1/4"
	LQ1U5A-R3		1/4" x 5/32"
	LQ1U5A-R4		3/16" x 0.127"
	LQ1U5A-R5		1/8" x 0.086"
	LQ1U6A-R2		1/2" x 3/8"
6	LQ1U6A-R3	1" x 7/8"	3/8" x 1/4"
	* LQ1U6A-R4		1/4" x 5/32"

Note 1) Products marked "*" are produced upon receipt of order. (The body of the fitting is PTFE machined.)

Note 2) For details of the applicable tubing sizes, refer to page 945.

Dimensions

Union reducing: LQ1U-R

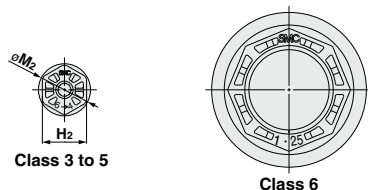
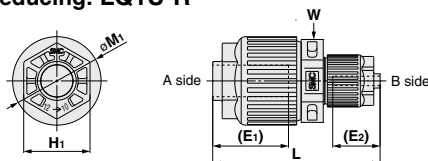

Metric Size

Model	A side	B side	E1	E2	H1	H2	L	M1	M2	Min. port size	W	
	Applicable tubing O.D.	Applicable tubing O.D.										
LQ1U31-R3	ø10	ø4	24	15	21	14	53	28	16.5	2.6	23	
LQ1U31-R4	ø10	ø3										1.8
LQ1U41-R2	ø12	ø8	24	15	21	14	53	28	16.5	2.6	23	
LQ1U41-R3	ø12	ø6										3.6
LQ1U41-R4	ø12	ø4										2.6
LQ1U41-R5	ø12	ø3										1.8
* LQ1U51-R2	ø19	ø10										7.4
* LQ1U51-R3	ø19	ø8	5.5									
LQ1U51-R4	ø19	ø6	29	26	39	66.5	39	16.5	2.6	3.6	32	
LQ1U51-R5	ø19	ø4										3.6
LQ1U51-R6	ø19	ø3	1.8									
LQ1U61-R2	ø25	ø12	39.5	24	36	21	87	49	28	9.4	46	
LQ1U61-R3	ø25	ø10										7.4
* LQ1U61-R5	ø25	ø6										2.6

Note) Products marked "*" are produced upon receipt of order. (The body of the fitting is PTFE machined.)

Inch Size

Model	A side	B side	E1	E2	H1	H2	L	M1	M2	Min. port size	W	
	Applicable tubing O.D.	Applicable tubing O.D.										
LQ1U4A-R2	1/2"	3/16"	24	15	21	14	53	28	16.5	2.9	23	
LQ1U4A-R3	1/2"	3/16"										3.6
LQ1U4A-R4	1/2"	1/8"										1.8
* LQ1U5A-R2	3/4"	3/8"	29	15	26	17	66.5	39	16.5	2.9	32	
LQ1U5A-R3	3/4"	1/4"										3.6
LQ1U5A-R4	3/4"	3/16"										2.6
LQ1U5A-R5	3/4"	1/8"										1.8
LQ1U6A-R2	1"	1/2"										7.4
LQ1U6A-R3	1"	3/8"	39.5	36	49	87	49	28	9	5.8	46	
* LQ1U6A-R4	1"	1/4"										20

Note) Products marked "*" are produced upon receipt of order. (The body of the fitting is PTFE machined.)

LQ1 Series

Space Saving Union Elbow

How to Order

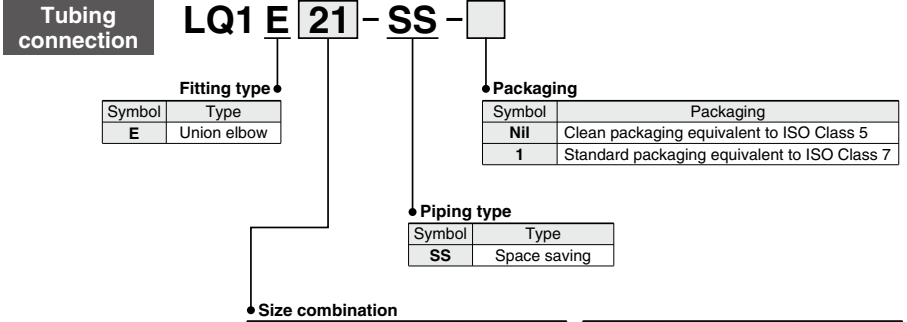

Size combination

Symbol Class	No.	Model	Applicable tubing size (mm)
2	1	LQ1E21-SS	6 x 4
3	1	LQ1E31-SS	10 x 8
3	2	LQ1E32-SS	8 x 6
4	1	LQ1E41-SS	12 x 10
5	1	* LQ1E51-SS	19 x 16
6	1	LQ1E61-SS	25 x 22

Note 1) Products marked "*" are produced upon receipt of order. (The body of the fitting is PTFE machined.)

Note 2) For details of the applicable tubing sizes, refer to page 945.

Symbol Class	No.	Model	Applicable tubing size (inch)
2	A	LQ1E2A-SS	1/4" x 5/32"
3	A	LQ1E3A-SS	3/8" x 1/4"
4	A	LQ1E4A-SS	1/2" x 3/8"
5	A	* LQ1E5A-SS	3/4" x 5/8"
6	A	LQ1E6A-SS	1" x 7/8"

Note 1) Products marked "*" are produced upon receipt of order. (The body of the fitting is PTFE machined.)

Note 2) For details of the applicable tubing sizes, refer to page 945.

Dimensions

Space saving union elbow: LQ1E-SS

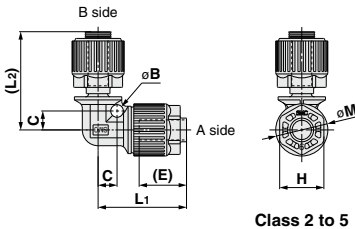

Class 2 to 5

Class 6

Metric Size

Model	A side	B side	B	C	E	H	L1	L2	M	Min. port size
	Applicable tubing O.D.	Applicable body size								
LQ1E21-SS	ø6	2	4	6	15	14	28	31.1	16.5	3.6
LQ1E31-SS	ø10	3	5	9	20	17	36.6	41.1	23	7.4
LQ1E32-SS	ø8	3	5	9	20	17	36.6	41.1	23	5.5
LQ1E41-SS	ø12	4	6	9	24	21	43	47.5	28	9.4
* LQ1E51-SS	ø19	5	—	—	29	26	45.5	59	39	15
LQ1E61-SS	ø25	6	8	18	39.5	36	69.5	75.5	49	21.2

Note) Products marked "*" are produced upon receipt of order. (The body of the fitting is PTFE machined.)

Inch Size

Model	A side	B side	B	C	E	H	L1	L2	M	Min. port size
	Applicable tubing O.D.	Applicable body size								
LQ1E2A-SS	1/4"	2	4	6	15	14	28	31.1	16.5	3.6
LQ1E3A-SS	3/8"	3	5	9	20	17	36.6	41.1	23	5.8
LQ1E4A-SS	1/2"	4	6	9	24	21	43	47.5	28	9
* LQ1E5A-SS	3/4"	5	—	—	29	26	45.5	59	39	15
LQ1E6A-SS	1"	6	8	18	39.5	36	69.5	75.5	49	21.2

Note) Products marked "*" are produced upon receipt of order. (The body of the fitting is PTFE machined.)

LQ1 Series Space Saving Union Elbow Reducing

How to Order

Tubing connection

LQ1 E 2 1 - SS - R9 -

Fitting type

Symbol	Type
E	Union elbow

Body size
(according to the combination table)

Tubing type

Symbol	Type
1, 2	Metric
A	Inch

Packaging

Symbol	Packaging
Nil	Clean packaging equivalent to ISO Class 5
1	Standard packaging equivalent to ISO Class 7

Piping type

Symbol	Type
R□	Reducing

Piping type (according to the combination table)

Symbol	Type
SS	Space saving

Size combination (Metric)

Class	Model	A side		B side	
		Applicable tubing size (mm)	Applicable body size	Applicable tubing size (mm)	Applicable body size
2	* LQ1E21-SS-R9	6 x 4	3	4	3
	* LQ1E21-SS-R10				
3	* LQ1E31-SS-R2	10 x 8	2	4	2
	* LQ1E31-SS-R8				
	* LQ1E32-SS-R1	8 x 6	2	3	3
	* LQ1E32-SS-R8				
4	* LQ1E41-SS-R1	12 x 10	2	5	3
	* LQ1E41-SS-R3				
	* LQ1E41-SS-R8				
6	LQ1E61-SS-R1	25 x 22	5	5	5

Note 1) Products marked "*" are produced upon receipt of order.
(The body of the fitting is PTFE machined.)

Note 2) For details of the applicable tubing sizes, refer to page 945.

Size combination (Inch)

Class	Model	A side		B side	
		Applicable tubing size (inch)	Applicable body size	Applicable tubing size (inch)	Applicable body size
2	* LQ1E2A-SS-R8	1/4" x 5/32"	3	4	3
	* LQ1E2A-SS-R9				
3	* LQ1E3A-SS-R1	3/8" x 1/4"	2	4	2
	* LQ1E3A-SS-R8				
	* LQ1E4A-SS-R1				
4	* LQ1E4A-SS-R2	1/2" x 3/8"	2	5	3
	* LQ1E4A-SS-R8				
6	LQ1E6A-SS-R1	1" x 7/8"	5	5	5

Note 1) Products marked "*" are produced upon receipt of order.
(The body of the fitting is PTFE machined.)

Note 2) For details of the applicable tubing sizes, refer to page 945.

Dimensions

Space saving union elbow reducing: LQ1E-SS-R

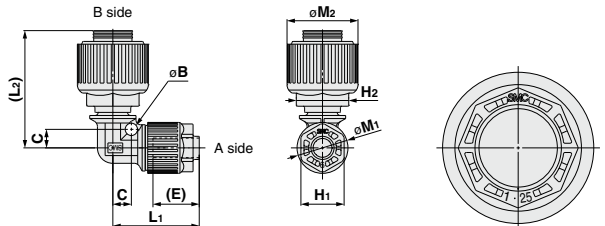

Class 2 to 5

Class 6

Metric Size

Model	A side Applicable tubing O.D.	B side Applicable body size	B	C	E	H ₁	H ₂	L ₁	L ₂	M ₁	M ₂	Min. port size
* LQ1E21-SS-R9	ø6	3	—	15	14	17	23.5	35.8	—	23	28	3.6
* LQ1E21-SS-R10		4	—	—	—	—	—	—	—	16.5	28	—
* LQ1E31-SS-R2	ø10	2	—	—	17	14	27.2	32.1	—	16.5	28	3.6
* LQ1E31-SS-R8		4	—	20	—	—	—	—	—	23	28	7.4
* LQ1E32-SS-R1	ø8	2	—	—	17	14	27.2	32.1	—	16.5	28	3.6
* LQ1E32-SS-R8		3	5	9	—	—	—	—	—	23	28	5.5
* LQ1E41-SS-R1	ø12	3	—	—	21	14	34.8	41.5	—	23	28	5.8
* LQ1E41-SS-R3		2	6	9	24	21	14	43	35.6	28	16.5	3.6
* LQ1E41-SS-R8		5	—	—	—	—	—	—	—	39	39	9.4
* LQ1E61-SS-R1	ø25	5	8	18	39.5	36	26	69.5	64.5	49	39	15

Note) Products marked "*" are produced upon receipt of order.
(The body of the fitting is PTFE machined.)

Inch Size

Model	A side Applicable tubing O.D.	B side Applicable body size	B	C	E	H ₁	H ₂	L ₁	L ₂	M ₁	M ₂	Min. port size
* LQ1E2A-SS-R8	1/4"	3	—	15	14	17	23.5	35.8	—	23	28	3.6
* LQ1E2A-SS-R9		4	—	—	—	—	—	—	—	16.5	28	—
* LQ1E3A-SS-R1	3/8"	2	—	20	17	14	27.2	32.1	—	16.5	28	3.6
* LQ1E3A-SS-R8		4	—	—	—	—	—	—	—	23	28	5.8
* LQ1E4A-SS-R1		3	—	—	—	—	—	—	—	23	28	5.8
* LQ1E4A-SS-R2	1/2"	2	—	24	21	14	43	35.6	—	28	16.5	3.6
* LQ1E4A-SS-R8		5	—	—	—	—	—	—	—	39	39	9
* LQ1E6A-SS-R1	1"	5	8	18	39.5	36	26	69.5	64.5	49	39	15

Note) Products marked "*" are produced upon receipt of order.
(The body of the fitting is PTFE machined.)

LQ1 Series

Space Saving Union Tee

How to Order

Tubing connection

LQ1 T 21 - S T1 -

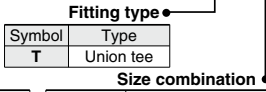

Packaging

Symbol	Packaging
Nil	Clean packaging equivalent to ISO Class 5
1	Standard packaging equivalent to ISO Class 7

Fitting type

Symbol	Type
T1	Type 1
T2	Type 2
T3	Type 3
T4	Type 4

Piping type

Symbol	Type
S	Space saving

Symbol Class	No.	Applicable tubing size (mm)
2	1	6 x 4
3	1	10 x 8
3	2	8 x 6
4	1	12 x 10
5	1	19 x 16
6	1	25 x 22

Symbol Class	No.	Applicable tubing size (inch)
2	A	1/4" x 5/32"
3	A	3/8" x 1/4"
4	A	1/2" x 3/8"
5	A	3/4" x 5/8"
6	A	1" x 7/8"

Note) For details of the applicable tubing sizes, refer to page 945.

Note) For details of the applicable tubing sizes, refer to page 945.

Dimensions

Space saving union tee: LQ1T-ST

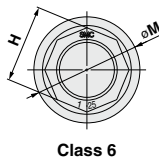
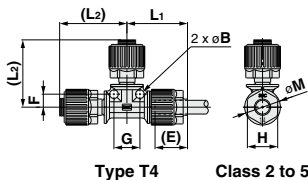
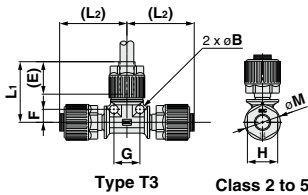
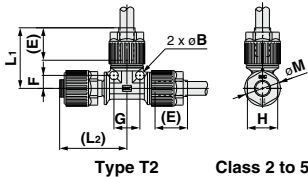
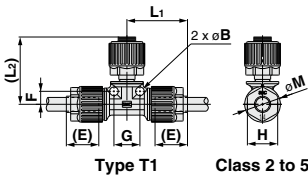

Metric Size

Model	Applicable tubing O.D.	B	E	F	G	H	L ₁	L ₂	M	Min. port size
LQ1T21-ST1	ø6	4	15	6	12	14	28	31.1	16.5	3.6
LQ1T21-ST2										
LQ1T21-ST3										
LQ1T21-ST4										
LQ1T31-ST1	ø10	5	20	9	18	17	36.5	41.1	23	5.8
LQ1T31-ST2										
LQ1T31-ST3										
LQ1T31-ST4										
LQ1T32-ST1	ø8	5	20	9	18	17	36.5	41.1	23	5.5
LQ1T32-ST2										
LQ1T32-ST3										
LQ1T32-ST4										
LQ1T41-ST1	ø12	6	24	9	18	21	43	47.5	28	9
LQ1T41-ST2										
LQ1T41-ST3										
LQ1T41-ST4										
LQ1T51-ST1	ø19	7	29	14	28	26	54	59	39	15
LQ1T51-ST2										
LQ1T51-ST3										
LQ1T51-ST4										
LQ1T61-ST1	ø25	8	39.5	18	36	36	69.5	75.5	49	21.2
LQ1T61-ST2										
LQ1T61-ST3										
LQ1T61-ST4										

Inch Size

Model	Applicable tubing O.D.	B	E	F	G	H	L ₁	L ₂	M	Min. port size
LQ1T2A-ST1	1/4"	4	15	6	12	14	28	31.1	16.5	3.6
LQ1T2A-ST2										
LQ1T2A-ST3										
LQ1T2A-ST4										
LQ1T3A-ST1	3/8"	5	20	9	18	17	36.5	41.1	23	5.8
LQ1T3A-ST2										
LQ1T3A-ST3										
LQ1T3A-ST4										
LQ1T4A-ST1	1/2"	6	24	9	18	21	43	47.5	28	9
LQ1T4A-ST2										
LQ1T4A-ST3										
LQ1T4A-ST4										
LQ1T5A-ST1	3/4"	7	29	14	28	26	54	59	39	15
LQ1T5A-ST2										
LQ1T5A-ST3										
LQ1T5A-ST4										
LQ1T6A-ST1	1"	8	39.5	18	36	36	69.5	75.5	49	21.2
LQ1T6A-ST2										
LQ1T6A-ST3										
LQ1T6A-ST4										

LQ1 Series Space Saving Union Tee Reducing

How to Order

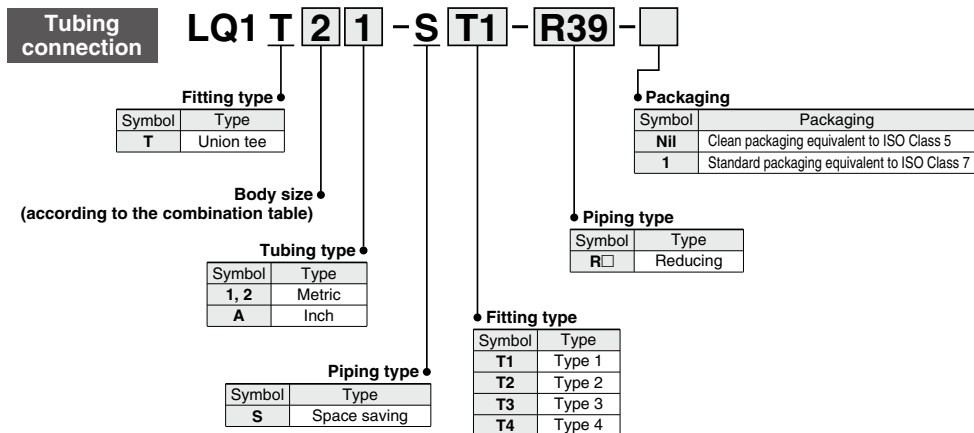

Size combination (Metric)

Class	Model	A side (Left)	B side (Center)	C side (Right)
		Applicable tubing size (O.D. x I.D.) / Applicable body size		
2	LQ1T21-ST1-R39	6 x 4	Body size 3	6 x 4
	LQ1T21-ST2-R41	Body size 3	6 x 4	
3	LQ1T32-ST1-R37	8 x 6	Body size 3	8 x 6
	LQ1T32-ST2-R40	Body size 3	8 x 6	
4	* LQ1T41-ST1-R1	12 x 10	Body size 3	12 x 10
	* LQ1T41-ST1-R37		Body size 5	
5	* LQ1T51-ST1-R1	19 x 16	Body size 4	19 x 16
	* LQ1T51-ST1-R2		Body size 3	
	LQ1T51-ST1-R5		Body size 5	
	* LQ1T51-ST1-R13	6 x 4	Body size 6	
	* LQ1T51-ST1-R36	12 x 10		
	* LQ1T51-ST1-R37	19 x 16		
6	* LQ1T61-ST1-R1	25 x 22	Body size 5	25 x 22
	* LQ1T61-ST1-R2		Body size 4	
	LQ1T61-ST2-R1	Body size 6	19 x 16	

Note 1) Products marked "*" are produced upon receipt of order.

(The body of the fitting is PTFE machined.)

Note 2) For details of the applicable tubing sizes, refer to page 945.

Size combination (Inch)

Class	Model	A side (Left)	B side (Center)	C side (Right)
		Applicable tubing size (O.D. x I.D.) / Applicable body size		
3	LQ1T3A-ST2-R5	Body size 3	3/8" x 1/4"	1/4" x 5/32"
4	* LQ1T4A-ST1-R1	1/2" x 3/8"	Body size 3	1/2" x 3/8"
	* LQ1T4A-ST1-R7	3/8" x 1/4"		
	* LQ1T4A-ST1-R37	1/2" x 3/8"	Body size 5	
5	* LQ1T5A-ST1-R1	3/4" x 5/8"	Body size 4	3/4" x 5/8"
	* LQ1T5A-ST1-R2		Body size 3	
	LQ1T5A-ST1-R5	Body size 5		
	* LQ1T5A-ST1-R7	1/2" x 3/8"	Body size 4	
	* LQ1T5A-ST1-R12	1/4" x 5/32"	Body size 5	
	* LQ1T5A-ST2-R1	Body size 4	3/4" x 5/8"	
6	* LQ1T5A-ST2-R3	Body size 5	1/4" x 5/32"	1" x 7/8"
	* LQ1T5A-ST3-R5	Body size 4	3/4" x 5/8"	
	* LQ1T6A-ST1-R1	1" x 7/8"	Body size 5	
	* LQ1T6A-ST1-R2		Body size 4	
	* LQ1T6A-ST1-R3	Body size 3	1" x 7/8"	
LQ1T6A-ST2-R1	Body size 6	3/4" x 5/8"		
	LQ1T6A-ST2-R2			3/4" x 5/8"

Note 1) Products marked "*" are produced upon receipt of order.

(The body of the fitting is PTFE machined.)

Note 2) For details of the applicable tubing sizes, refer to page 945.

LVC

LVA

LVH

LVD

LVQ

LVP

LVW

LQ1

LQ3

LVN

LQHB

TL

TIL

TLM

TILM

TD

TID

TH

TIH

LQ1 Series

Dimensions

Space saving union tee reducing: LQ1T-S-R

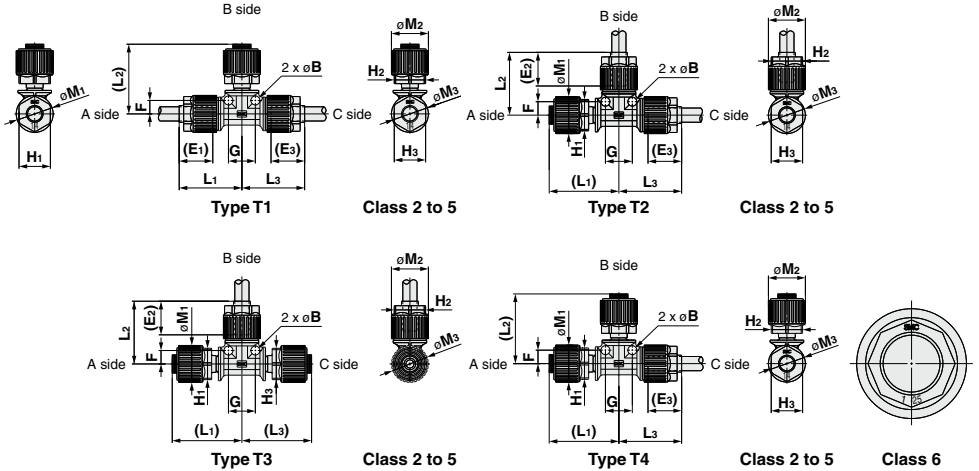

Metric Size

Model	A side (Left)	B side (Center)	C side (Right)	B	E ₁	E ₂	E ₃	F	G	H ₁	H ₂	H ₃	L ₁	L ₂	L ₃	M ₁	M ₂	M ₃	Min. port size
	Applicable tubing O.D.																		
LQ1T21-ST1-R39	ø6	Body size 3	ø6	5	20	—	20	9	18	17	17	17	36.5	41.1	36.5	23	23	23	3.6
LQ1T21-ST2-R41	Body size 3	ø6	ø6	—	—	20	—	—	—	—	—	—	41.1	36.5	—	—	—	—	—
LQ1T32-ST1-R37	ø8	Body size 3	ø8	5	20	—	20	9	18	17	17	17	36.5	41.1	36.5	23	23	23	5.5
LQ1T32-ST2-R40	Body size 3	ø8	ø8	—	—	20	—	—	—	—	—	—	41.1	36.5	—	—	—	—	—
* LQ1T41-ST1-R1	ø12	Body size 3	ø12	—	24	—	24	—	—	21	17	21	34	41.5	34	28	23	28	5.8
* LQ1T41-ST1-R37	ø12	Body size 5	ø12	—	24	—	24	—	—	21	26	21	39.5	52.5	39.5	28	39	28	9.4
* LQ1T51-ST1-R1	ø19	Body size 4	ø19	—	—	—	—	—	—	21	—	—	41.9	53	41.9	—	28	—	9
* LQ1T51-ST1-R2	ø19	Body size 3	ø19	—	29	—	29	—	—	26	17	26	41	48	41	39	23	39	5.8
LQ1T51-ST1-R5	ø12	Body size 5	ø19	7	—	—	—	14	28	—	26	—	54	59	54	—	39	—	9.4
* LQ1T51-ST1-R13	ø6	Body size 5	ø19	—	15	—	29	—	—	14	26	26	29	53	49	16.5	39	39	3.6
* LQ1T51-ST1-R36	ø12	Body size 6	ø19	—	24	—	39.5	—	—	36	—	36	36	42.7	71	58.2	49	—	9.4
* LQ1T51-ST1-R37	ø19	Body size 6	ø12	—	39.5	—	—	—	—	14	26	26	58.2	71	42.7	16.5	49	39	9.4
LQ1T51-ST2-R4	Body size 5	ø6	ø19	7	—	15	24	14	28	26	14	26	54	54	39	16.5	39	39	3.6
* LQ1T61-ST1-R1	ø25	Body size 5	ø25	—	39.5	—	—	—	—	—	26	—	58.2	63.5	—	—	39	—	15
* LQ1T61-ST1-R2	ø25	Body size 4	ø25	—	39.5	—	39.5	—	—	36	21	36	58.2	57	58.2	49	28	49	9
LQ1T61-ST2-R1	Body size 6	ø19	ø25	8	—	39.5	—	18	36	—	36	—	72	69.5	69.5	—	49	—	15

Inch Size

Model	A side (Left)	B side (Center)	C side (Right)	B	E ₁	E ₂	E ₃	F	G	H ₁	H ₂	H ₃	L ₁	L ₂	L ₃	M ₁	M ₂	M ₃	Min. port size
	Applicable tubing O.D.																		
LQ1T3A-ST2-R5	Body size 3	3/8	1/4	5	—	15	20	9	18	17	14	17	37.6	31.6	36.5	23	16.5	23	3.6
* LQ1T4A-ST1-R1	1/2	Body size 3	1/2	—	24	—	24	—	—	17	17	21	34	41.5	34	28	—	23	5.8
* LQ1T4A-ST1-R7	3/8	Body size 3	1/2	—	20	—	24	—	—	17	17	21	38.5	41.5	34	23	—	28	5.8
* LQ1T4A-ST1-R37	1/2	Body size 5	1/2	—	24	—	—	—	—	21	26	—	39.5	52.5	39.5	28	39	9	
* LQ1T5A-ST1-R1	3/4	Body size 4	3/4	—	29	—	—	—	—	21	—	—	41.9	53	41.9	—	28	—	9
* LQ1T5A-ST1-R2	3/4	Body size 3	3/4	—	29	—	—	—	—	26	17	—	41	48	41	39	23	—	5.8
LQ1T5A-ST1-R5	1/2	Body size 5	3/4	7	15	—	29	14	28	—	26	—	38.5	55.5	—	16.5	39	—	9.4
LQ1T5A-ST1-R7	1/2	Body size 4	3/4	7	29	—	—	—	—	21	21	26	54	55.5	54	28	28	39	9
* LQ1T5A-ST1-R12	1/4	Body size 5	3/4	—	—	—	—	—	—	14	26	—	29	53	49	16.5	—	—	3.6
* LQ1T5A-ST2-R1	Body size 4	3/4	3/4	—	—	29	—	—	—	21	26	—	50.5	51.5	52.5	28	39	—	9
LQ1T5A-ST2-R3	Body size 5	1/4	3/4	7	—	15	29	14	28	26	14	—	59	38	54	39	16.5	—	3.6
* LQ1T5A-ST3-R5	Body size 4	3/4	Body size 4	—	—	29	—	—	—	21	26	21	50.5	44.5	50.5	28	39	28	9
* LQ1T6A-ST1-R1	1	Body size 5	1	—	—	—	—	—	—	26	—	—	63.5	—	—	—	39	—	15
* LQ1T6A-ST1-R2	1	Body size 4	1	—	39.5	—	—	—	—	21	—	—	58.2	57	58.2	—	28	—	9
* LQ1T6A-ST1-R3	1	Body size 3	1	—	—	—	39.5	—	—	36	17	36	52	—	—	49	23	49	5.8
LQ1T6A-ST2-R1	Body size 6	3/4	1	—	—	—	—	—	—	—	—	—	75.5	69.5	69.5	—	—	—	15
LQ1T6A-ST2-R2	Body size 6	3/4	3/4	8	—	39.5	—	18	36	—	36	—	75.5	69.5	69.5	—	49	—	15

Note) Products marked "*" are produced upon receipt of order. (The body of the fitting is PTFE machined.)

Tubing Extension Union Elbow

How to Order

Tubing connection **LQ1 E 21 - T -**

Fitting type

Symbol	Type
E	Union elbow

Packaging

Symbol	Packaging
Nil	Clean packaging equivalent to ISO Class 5
1	Standard packaging equivalent to ISO Class 7

Piping type

Symbol	Type
T	Tubing extension

Size combination

Symbol	Class	No.	Applicable tubing size (mm)
2	1	1	6 x 4
3	1	1	10 x 8
3	2	2	8 x 6
4	1	1	12 x 10
5	1	1	19 x 16
6	1	1	25 x 22

Symbol	Class	No.	Applicable tubing size (inch)
2	A	A	1/4" x 5/32"
3	A	A	3/8" x 1/4"
4	A	A	1/2" x 3/8"
5	A	A	3/4" x 5/8"
6	A	A	1" x 7/8"

Note) For details of the applicable tubing sizes, refer to page 945.

LVC
LVA
LVB
LVD
LVQ
LVP
LVV
LQ1
LQ3
LVN
LQHB
TL
TIL
TLM
TILM
TD
TID
TH
TIH

Dimensions

Tubing extension union elbow: LQ1E-T

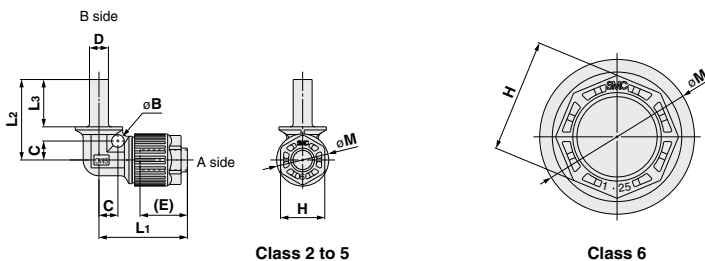

Metric Size

Model	A side	B side	B	C	E	H	L1	L2	L3	M	Min. port size
	Applicable tubing O.D.	Tubing size (D)									
LQ1E21-T	ø6	6 x 4	4	6	15	14	28	25.5	15	16.5	3.6
LQ1E31-T	ø10	10 x 8	5	9	20	17	36.6	33.6	20	23	7.4
LQ1E32-T	ø8	8 x 6	—	—	—	—	—	—	—	—	5.5
LQ1E41-T	ø12	12 x 10	6	9	24	21	43	39	24	28	9.4
*LQ1E51-T	ø19	19 x 16	—	—	29	26	45.5	55.5	35	39	15
LQ1E61-T	ø25	25 x 22	8	18	39.5	36	69.5	72	46	49	21.2

Inch Size

Model	A side	B side	B	C	E	H	L1	L2	L3	M	Min. port size
	Applicable tubing O.D.	Tubing size (D)									
LQ1E2A-T	1/4"	1/4" x 5/32"	4	6	15	14	28	25.5	15	16.5	3.6
LQ1E3A-T	3/8"	3/8" x 1/4"	5	9	20	17	36.6	33.6	20	23	5.8
LQ1E4A-T	1/2"	1/2" x 3/8"	6	9	24	21	43	40	25	28	9
*LQ1E5A-T	3/4"	3/4" x 5/8"	—	—	29	26	45.5	55.5	35	39	15
LQ1E6A-T	1"	1" x 7/8"	8	18	39.5	36	69.5	72	46	49	21.2

Note) Products marked "*" are produced upon receipt of order.
(The body of the fitting is PTFE machined.)

Note) Products marked "*" are produced upon receipt of order.
(The body of the fitting is PTFE machined.)

Tubing Extension Union Tee

How to Order

Tubing connection

LQ1 T 21 - T T1 - □

Fitting type

Symbol	Type
T	Union tee

Size combination

Symbol Class	No.	Applicable tubing size (inch)
2	A	1/4" x 5/32"
3	A	3/8" x 1/4"
4	A	1/2" x 3/8"
5	A	3/4" x 5/8"
6	A	1" x 7/8"

Packaging

Symbol	Packaging
Nil	Clean packaging equivalent to ISO Class 5
1	Standard packaging equivalent to ISO Class 7

Symbol Class	No.	Applicable tubing size (mm)
2	1	6 x 4
3	1	10 x 8
3	2	8 x 6
4	1	12 x 10
5	1	19 x 16
6	1	25 x 22

Piping type

Symbol	Type
T	Tubing extension

Fitting type

Symbol	Type
T1	Type 1
T2	Type 2
T3	Type 3
T4	Type 4

Note) For details of the applicable tubing sizes, refer to page 945.

Note) For details of the applicable tubing sizes, refer to page 945.

Dimensions

Tubing extension union tee: LQ1T-TT

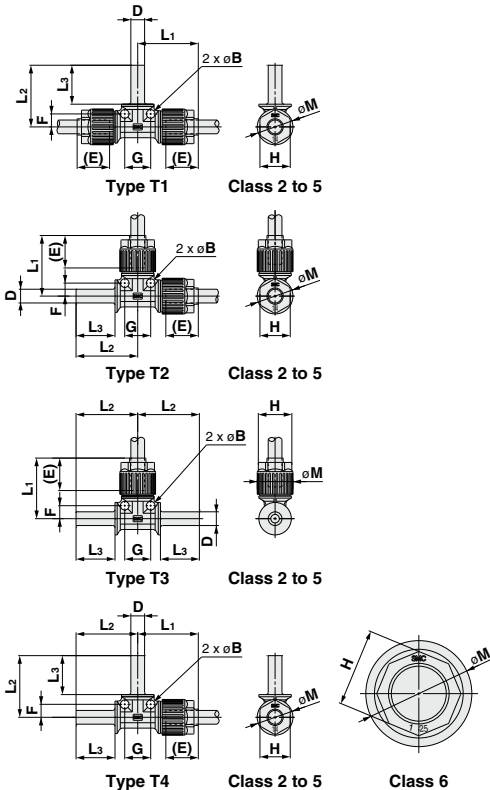

Metric Size

Model	Applicable tubing O.D.	B	D	E	F	G	H	L ₁	L ₂	L ₃	M	Min. port size
* LQ1T21-TT1	ø6	—	6 x 4	15	—	14	21.5	25.5	26.5	18	16.5	3.6
* LQ1T21-TT2												
* LQ1T31-TT1	ø10	—	10 x 8	20	—	17	30.6	34.5	35.5	24	23	7.4
* LQ1T31-TT2												
* LQ1T32-TT1	ø8	—	8 x 6	20	—	17	34.5	35.5	24	23	23	5.5
* LQ1T32-TT2												
* LQ1T32-TT3	ø12	—	10 x 8	24	—	21	41.5	41	28	28	28	9.4
* LQ1T41-TT1												
* LQ1T41-TT2	ø19	7	19 x 16	29	14	28	26	54	55.5	35	39	15
* LQ1T41-TT3												
LQ1T51-TT1	ø25	8	25 x 22	39.5	18	36	36	69.5	65.5	39.5	49	21.2
LQ1T51-TT2												
LQ1T51-TT3	LQ1T61-TT1	LQ1T61-TT2	LQ1T61-TT3	LQ1T61-TT4								

Inch Size

Model	Applicable tubing O.D.	B	D	E	F	G	H	L ₁	L ₂	L ₃	M	Min. port size
LQ1T2A-TT1	1/4"	4	1/4" x 5/32"	15	6	12	14	28	28.5	18	16.5	3.6
LQ1T2A-TT2												
LQ1T2A-TT3												
LQ1T2A-TT4	3/8"	5	3/8" x 1/4"	20	9	18	17	36.5	37.6	24	23	5.8
LQ1T3A-TT1												
LQ1T3A-TT2												
LQ1T3A-TT3	1/2"	6	1/2" x 3/8"	24	9	18	21	43	43	28	28	9
LQ1T4A-TT1												
LQ1T4A-TT2												
LQ1T4A-TT3	3/4"	7	3/4" x 5/8"	29	14	28	26	54	55.5	35	39	15
LQ1T5A-TT1												
LQ1T5A-TT2												
LQ1T5A-TT3	1"	8	1" x 7/8"	39.5	18	36	36	69.5	65.5	39.5	49	21.2
LQ1T6A-TT1												
LQ1T6A-TT2												
LQ1T6A-TT3	LQ1T6A-TT4											

Note) Products marked "*" are produced upon receipt of order.
(The body of the fitting is PTFE machined.)

Tubing Extension Union Elbow Reducing

How to Order

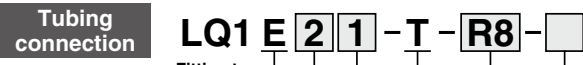

Size combination (Metric)

Class	Model	A side Applicable tubing size (mm)	B side Tubing size (mm)	
2	LQ1E21-T-R8	6 x 4	8 x 6	
	LQ1E21-T-R9		10 x 8	
	LQ1E21-T-R10		12 x 10	
	LQ1E22-T-R8	4 x 3	6 x 4	
	LQ1E22-T-R9		8 x 6	
	LQ1E22-T-R10		10 x 8	
3	LQ1E22-T-R11	10 x 8	12 x 10	
	LQ1E31-T-R1		8 x 6	
	LQ1E31-T-R2		6 x 4	
	LQ1E31-T-R8	8 x 6	12 x 10	
	LQ1E31-T-R9		19 x 16	
	LQ1E32-T-R1		6 x 4	
4	LQ1E32-T-R8	8 x 6	10 x 8	
	LQ1E32-T-R9		12 x 10	
	LQ1E32-T-R10		19 x 16	
	LQ1E41-T-R1	12 x 10	10 x 8	
	LQ1E41-T-R2		8 x 6	
	LQ1E41-T-R3		6 x 4	
5	LQ1E41-T-R8	19 x 16	19 x 16	
	LQ1E41-T-R9		25 x 22	
	LQ1E51-T-R8		25 x 22	
	6	LQ1E61-T-R1	25 x 22	19 x 16

Note 1) Products marked "*" are produced upon receipt of order. (The body of the fitting is PTFE machined.)

Note 2) For details of the applicable tubing sizes, refer to page 945.

Fitting type

Symbol	Type
E	Union elbow

(according to the combination table)

Body size

Symbol	Type
1, 2	Metric
A	Inch

Tubing type

Piping type

Symbol	Type
R□	Reducing

Piping type

Symbol	Type
T	Tubing extension

Packaging

Symbol	Packaging
Nil	Clean packaging equivalent to ISO Class 5
1	Standard packaging equivalent to ISO Class 7

Size combination (Inch)

Class	Model	A side Applicable tubing size (inch)	B side Tubing size (inch)
2	* LQ1E2A-T-R8	1/4" x 5/32"	3/8" x 1/4"
	* LQ1E2A-T-R9		1/2" x 3/8"
3	* LQ1E3A-T-R1	3/8" x 1/4"	1/4" x 5/32"
	* LQ1E3A-T-R8		1/2" x 3/8"
	* LQ1E3A-T-R9		3/4" x 5/8"
4	* LQ1E4A-T-R1	1/2" x 3/8"	3/8" x 1/4"
	* LQ1E4A-T-R8		3/4" x 5/8"
	* LQ1E4A-T-R9		1" x 7/8"
5	* LQ1E5A-T-R8	3/4" x 5/8"	1" x 7/8"
	LQ1E6A-T-R1		3/4" x 5/8"

Note 1) Products marked "*" are produced upon receipt of order. (The body of the fitting is PTFE machined.)

Note 2) For details of the applicable tubing sizes, refer to page 945.

Dimensions

Tubing extension union elbow reducing: LQ1E-T-R

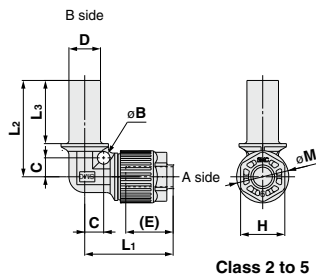

Class 2 to 5

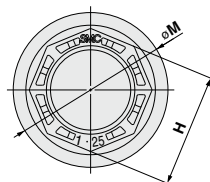

Class 6

Note) Products marked "*" are produced upon receipt of order. (The body of the fitting is PTFE machined.)

Metric Size

Model	A side Applicable tubing O.D.	B side Tubing size (D)	B	C	D	E	H	L ₁	L ₂	L ₃	M	Min. port size
LQ1E21-T-R8	ø6	8 x 6	4	6	8	15	14	28	30.5	20	16.5	3.6
LQ1E21-T-R9		10 x 8							34.5	24		
LQ1E21-T-R10		12 x 10							37.6	24		
LQ1E22-T-R8	ø4	6 x 4	5	9	6	20	17	25.5	15	23	3.9	
LQ1E22-T-R9		8 x 6						30.5	20			
LQ1E22-T-R10		10 x 8						33.5	24			
LQ1E22-T-R11	12 x 10	37.6	24	6	9	15	16.5	16.5	3.9	7.4		
LQ1E31-T-R1	8 x 6	33.5	24									
LQ1E31-T-R2	6 x 4	36.6	15									
LQ1E31-T-R8	ø10	12 x 10	6	12	20	24	21	37.6	24	28	3.9	
* LQ1E31-T-R9		19 x 16						33.5	46.5			35
LQ1E32-T-R1		6 x 4						28.6	15			
LQ1E32-T-R8	ø8	10 x 8	5	9	10	12	17	36.6	33.6	23	5.5	
LQ1E32-T-R9		12 x 10						37.6	24			
* LQ1E32-T-R10		19 x 16						33.5	46.5			35
LQ1E41-T-R1	ø12	10 x 8	6	9	8	24	21	35	20	28	3.9	
LQ1E41-T-R2		8 x 6						41	60			46
LQ1E41-T-R3		6 x 4						39.6	49			35
* LQ1E41-T-R8	ø19	19 x 16	8	18	19	25	29	39.6	49	35	9.4	
* LQ1E41-T-R9		25 x 22						41	60			46
* LQ1E51-T-R8		25 x 22						25	29			26
LQ1E61-T-R1	ø25	19 x 16	8	18	19	39.5	36	69.5	61	35	49	15.8

Inch Size

Model	A side Applicable tubing O.D.	B side Tubing size (D)	B	C	D	E	H	L ₁	L ₂	L ₃	M	Min. port size
* LQ1E2A-T-R8	1/4"	3/8" x 1/4"	—	—	3/8"	15	14	23.5	32.3	24	16.5	3.6
* LQ1E2A-T-R9		1/2" x 3/8"						25	36.3	28		
* LQ1E3A-T-R1	3/8"	1/4" x 5/32"	—	—	1/4"	20	17	27.2	29.5	18	23	3.9
* LQ1E3A-T-R8		1/2" x 3/8"						30.4	39.5	28		
* LQ1E3A-T-R9		3/4" x 5/8"						33.5	46.5	35		
* LQ1E4A-T-R1	1/2"	3/8" x 1/4"	—	—	3/8"	24	21	34.8	38	24	28	6.3
* LQ1E4A-T-R8		1" x 7/8"						39.6	49	35		
* LQ1E4A-T-R9		1" x 7/8"						41	60	46		
* LQ1E5A-T-R8	3/4"	1" x 7/8"	—	—	1"	29	26	48.5	66.5	46	39	15
LQ1E6A-T-R1	1"	3/4" x 5/8"	8	18	3/4"	39.5	36	69.5	61	35	49	15.8

Tubing Extension Union Tee Reducing

How to Order

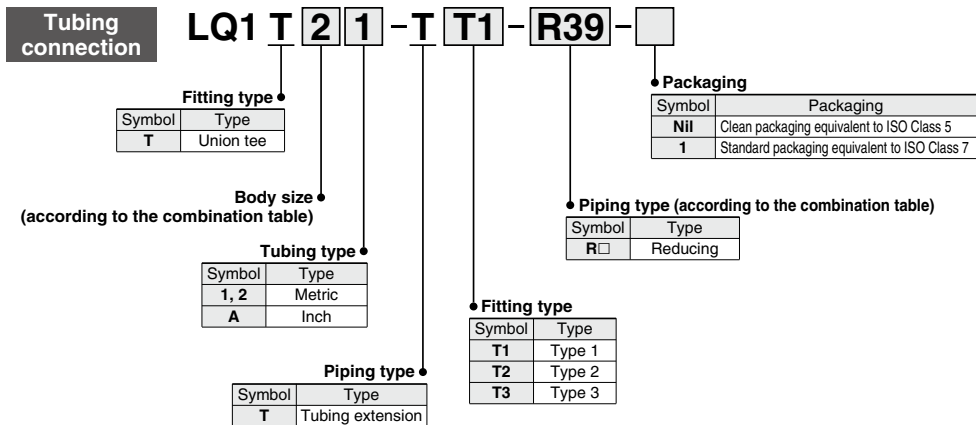

Size combination (Metric)

Class	Model	A side (Left)	B side (Center)	C side (Right)
		Applicable tubing size (O.D. x I.D.) / Tubing extensions (O.D. x I.D.)		
2	* LQ1T21-TT1-R39	6 x 4	Tube 10 x 8	6 x 4
	* LQ1T21-TT2-R41	Tube 10 x 8	6 x 4	
3	* LQ1T32-TT1-R37	8 x 6	Tube 10 x 8	8 x 6
	* LQ1T32-TT2-R40	Tube 10 x 8	8 x 6	
4	* LQ1T41-TT1-R1	12 x 10	Tube 10 x 8	12 x 10
	* LQ1T41-TT1-R37		Tube 19 x 16	
5	* LQ1T51-TT1-R1	19 x 16	Tube 12 x 10	19 x 16
	* LQ1T51-TT1-R2		Tube 10 x 8	
	* LQ1T51-TT1-R5		12 x 10	
	* LQ1T51-TT1-R13		6 x 4	
	* LQ1T51-TT1-R37		19 x 16	
	* LQ1T51-TT1-R38		6 x 4	
	* LQ1T51-TT2-R4		Tube 19 x 16	
6	* LQ1T61-TT1-R1	25 x 22	Tube 19 x 16	25 x 22
	* LQ1T61-TT1-R2		Tube 1/2" x 3/8"	
	* LQ1T61-TT2-R1		Tube 25 x 22	

Note 1) Products marked "*" are produced upon receipt of order.

(The body of the fitting is PTFE machined.)

Note 2) For details of the applicable tubing sizes, refer to page 945.

Size combination (Inch)

Class	Model	A side (Left)	B side (Center)	C side (Right)	
		Applicable tubing size (O.D. x I.D.) / Tubing extensions (O.D. x I.D.)			
3	LQ1T3A-TT2-R5	Tube 3/8" x 1/4"	3/8" x 1/4"	1/4" x 5/32"	
4	* LQ1T4A-TT1-R1	1/2" x 3/8"	Tube 3/8" x 1/4"	1/2" x 3/8"	
	* LQ1T4A-TT1-R7	3/8" x 1/4"			
	* LQ1T4A-TT1-R37	1/2" x 3/8"			Tube 3/4" x 5/8"
5	* LQ1T5A-TT1-R1	3/4" x 5/8"	Tube 1/2" x 3/8"	3/4" x 5/8"	
	* LQ1T5A-TT1-R2		Tube 3/8" x 1/4"		
	* LQ1T5A-TT1-R3		1/4" x 5/32"		
	* LQ1T5A-TT1-R5		Tube 3/4" x 5/8"		
	* LQ1T5A-TT1-R7		1/2" x 3/8"		Tube 1/2" x 3/8"
	* LQ1T5A-TT2-R4		Tube 3/4" x 5/8"		1/4" x 5/32"
	* LQ1T5A-TT2-R40		Tube 1" x 7/8"		3/4" x 5/8"
	* LQ1T5A-TT3-R5		Tube 3/4" x 5/8"		
* LQ1T5A-TT3-R7	Tube 1/2" x 3/8"	Tube 1/2" x 3/8"			
6	* LQ1T6A-TT1-R1	1" x 7/8"	Tube 3/4" x 5/8"	1" x 7/8"	
	* LQ1T6A-TT1-R2		Tube 1/2" x 3/8"		
	* LQ1T6A-TT1-R3		Tube 3/8" x 1/4"		
	* LQ1T6A-TT2-R1		Tube 3/4" x 5/8"		3/4" x 5/8"

Note 1) Products marked "*" are produced upon receipt of order.

(The body of the fitting is PTFE machined.)

Note 2) For details of the applicable tubing sizes, refer to page 945.

Dimensions

Tubing extension union tee reducing: LQ1T-T-R

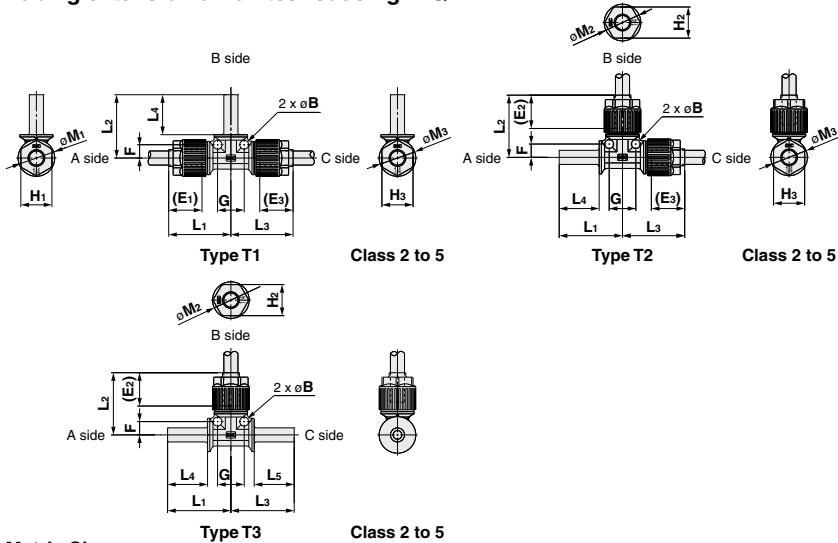

Metric Size

Model	A side (Left) Applicable tubing O.D.	B side (Center) Applicable tubing O.D.	C side (Right) Applicable tubing O.D.	B	E1	E2	E3	F	G	H1	H2	H3	L1	L2	L3	L4	L5	M1	M2	M3	Min. port size
* LQ1T21-TT1-R39	ø6	Tube ø10	ø6	—	20	—	20	—	—	17	—	17	30.6	35.5	30.6	24	—	23	—	23	3.6
* LQ1T21-TT2-R41	Tube ø10	ø6	ø6	—	20	—	20	—	—	17	—	17	35.5	34.5	34.5	24	—	23	—	23	—
* LQ1T32-TT1-R37	ø8	Tube ø10	ø8	—	20	—	20	—	—	17	—	17	30.6	35.5	30.6	24	—	23	—	23	5.5
* LQ1T32-TT2-R40	Tube ø10	ø8	ø8	—	20	—	20	—	—	17	—	17	35.5	34.5	34.5	24	—	23	—	23	—
* LQ1T41-TT1-R1	ø12	Tube ø10	ø12	—	24	—	24	—	—	21	—	21	35	38	35	24	—	28	—	28	8
* LQ1T41-TT1-R37	ø12	Tube ø19	ø12	—	24	—	24	—	—	21	—	21	39.5	49	39.5	35	—	39	—	39	9.4
* LQ1T51-TT1-R1	ø19	Tube ø12	ø19	—	29	—	29	—	—	26	—	26	41.5	47.5	41.5	28	—	39	—	39	10
* LQ1T51-TT1-R2	ø19	Tube ø10	ø19	—	29	—	29	—	—	26	—	26	39.5	49	39.5	35	—	39	—	39	8
* LQ1T51-TT1-R5	ø12	Tube ø19	ø19	7	—	—	—	14	28	—	—	—	54	55.5	54	35	—	—	—	—	9.4
* LQ1T51-TT1-R13	ø6	Tube ø19	ø19	—	15	—	29	—	—	14	—	26	29	54.5	45	35	16.5	—	39	—	3.6
* LQ1T51-TT1-R37	ø19	Tube ø25	ø19	8	39.5	—	39.5	18	36	36	—	36	69.5	65.5	69.5	39.5	49	—	49	—	15
* LQ1T51-TT1-R38	ø6	Tube ø25	ø19	—	15	—	29	—	—	14	—	26	32.2	64	48.2	46	16.5	—	39	—	3.6
* LQ1T51-TT2-R4	Tube ø19	ø6	ø19	7	—	15	29	14	28	—	14	26	55.5	38.5	54	35	—	—	—	16.5	3.6
* LQ1T61-TT1-R1	ø25	Tube ø19	ø25	—	39.5	—	—	—	—	36	21	36	55.1	59.5	55.1	35	—	49	—	49	16
* LQ1T61-TT1-R2	ø25	Tube 1/2	ø25	—	39.5	—	39.5	—	—	36	26	36	53.5	52.5	53.5	28	—	49	—	49	9.5
* LQ1T61-TT2-R1	Tube ø25	ø19	ø25	8	—	39.5	—	18	36	—	36	—	65.5	69.5	69.5	39.5	—	49	—	49	15

Inch Size

Model	A side (Left) Applicable tubing O.D.	B side (Center) Applicable tubing O.D.	C side (Right) Applicable tubing O.D.	B	E1	E2	E3	F	G	H1	H2	H3	L1	L2	L3	L4	L5	M1	M2	M3	Min. port size	
LQ1T3A-TT2-R5	Tube 3/8	3/8	1/4	5	—	20	15	9	18	—	17	14	37.6	36.6	36.6	24	—	23	—	23	16.5	3.6
* LQ1T4A-TT1-R1	1/2	Tube 3/8	1/2	—	24	—	24	—	—	21	—	21	34	38	34	24	—	28	—	28	6.3	
* LQ1T4A-TT1-R7	3/8	Tube 3/8	1/2	—	20	—	24	—	—	17	—	17	21	34	38	34	24	—	23	—	28	5.8
* LQ1T4A-TT1-R37	1/2	Tube 3/4	1/2	—	24	—	24	—	—	21	—	21	39.5	49	39.5	35	—	28	—	28	9	
* LQ1T5A-TT1-R1	3/4	Tube 1/2	3/4	—	29	—	29	—	—	26	—	26	41.9	47.5	41.9	28	—	39	—	39	9.5	
* LQ1T5A-TT1-R2	3/4	Tube 3/8	3/4	—	29	—	29	—	—	26	—	26	41	44.5	41	24	—	39	—	39	6.3	
* LQ1T5A-TT1-R3	1/4	Tube 3/4	3/4	—	15	—	29	—	—	14	—	26	29	54.5	45	35	—	16.5	—	39	3.6	
* LQ1T5A-TT1-R5	1/2	Tube 3/4	3/4	7	29	—	29	14	28	26	—	26	54	55.5	54	35	—	39	—	39	9	
* LQ1T5A-TT1-R7	1/2	Tube 1/2	3/4	7	29	—	29	14	28	26	—	26	49	44.5	54	24	—	39	—	39	9	
* LQ1T5A-TT2-R4	Tube 3/4	1/4	3/4	7	—	15	29	14	28	—	14	26	55.5	38.5	54	35	—	—	—	16.5	3.6	
* LQ1T5A-TT2-R40	Tube 1	3/4	3/4	—	29	29	—	—	—	26	26	64	54	51.5	46	—	—	39	—	39	15	
* LQ1T5A-TT3-R5	Tube 3/4	3/4	Tube 1/2	7	—	29	—	14	28	—	26	—	48.5	54	55.5	35	28	—	39	—	9.5	
* LQ1T5A-TT3-R7	Tube 1/2	3/4	Tube 1/2	—	29	—	—	—	—	26	—	26	46	44.5	46	28	—	39	—	39	—	
* LQ1T6A-TT1-R1	ø25	Tube 3/4	ø25	—	39.5	—	—	—	—	36	—	36	55.1	59.5	55.1	35	—	—	—	—	16	
* LQ1T6A-TT1-R2	ø25	Tube 1/2	ø25	—	39.5	—	39.5	—	—	36	—	36	52.5	52.5	52.5	28	—	49	—	49	9.5	
* LQ1T6A-TT1-R3	ø25	Tube 3/8	ø25	—	39.5	—	39.5	—	—	36	—	36	53.5	48.5	53.5	24	—	—	—	—	6.3	
* LQ1T6A-TT2-R1	Tube 1	ø19	ø25	8	—	39.5	—	18	36	—	36	—	65.5	69.5	69.5	39.5	—	49	—	49	15	

Note) Products marked "*" are produced upon receipt of order. (The body of the fitting is PTFE machined.)

LVC
LVA
LVH
LVD
LVQ
LVP
LVW
LQ1
LQ3
LVN
LQHB
TL
TIL
TLM
TILM
TD
TID
TH
TIH



LQ1 Series

How to Order Space Saving Type Fittings

This product, for use with products with one nut attached (insert bushing) has one nut removed.

LQ1 E 21 - SN -

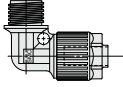
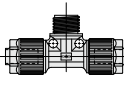
Fitting type

E	T
Union Elbow 	Union Tee 
P	U
Panel Mount Union 	Union 

Packaging

Symbol	Packaging
NII	Clean packaging equivalent to ISO Class 5
1	Standard packaging equivalent to ISO Class 7

• Without a nut (including insert bushing) in one part

• Combination of different diameter (on B side)

Symbol	Applicable tubing size	Symbol	Applicable tubing size
Size	No.	Size	No.
1	1	1	A
1	2	—	—
2	1	2	A
2	2	2	B
3	1	2	C
3	2	3	A
3	3	3	B
4	1	4	A
4	2	4	B
5	1	5	A
5	2	5	B
6	1	6	A
6	2	6	B

Connection example

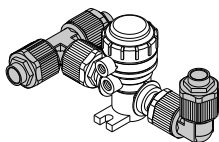

Note 1) For each body class, the second and later numbers or symbols indicate reducing. However, use of different diameters is not available with size 1.

Note 2) Please choose the same size fitting as the fitting of the connecting product.

Note 3) For details of applicable tubing sizes, refer to page 945.

Options

Panel mounting nut

LQN P 11 -

Applicable fitting

Symbol	Size
11	1
12	2
13	3
14	4
15	5
16	6

Packaging

Symbol	Packaging
NII	Clean packaging equivalent to Class M3.5
1	Standard packaging equivalent to Class M5.5

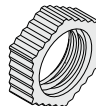

It is used to mount panels with a panel mount union.

Options

Nut insert bush

LQ1-2U03 - [] In cases where exchanging the tubing size, we recommend the U type.

Applicable fitting

Symbol	Applicable fitting
1	LQ1

Size

Symbol	Size
1	1
2	2
3	3
4	4
5	5
6	6

Type of part

Symbol	Type of part
U	Nut insert bush
B	Insert bush
N	Nut

Packaging

Symbol	Packaging
Nil	Clean packaging equivalent to ISO Class 5
1	Standard packaging equivalent to ISO Class 7

Applicable tubing size

Metric Size

Symbol	Applicable tubing size	Size					
		1	2	3	4	5	6
03	ø3 x ø2	○	●				
04	ø4 x ø3	○	●				
06	ø6 x ø4		○	●			
08	ø8 x ø6			○	●		
10	ø10 x ø8				○	●	
12	ø12 x ø10					○	●
19	ø19 x ø16						○
25	ø25 x ø22.5						○

Inch Size

Symbol	Applicable tubing size	Size					
		1	2	3	4	5	6
03	1/8" x 0.086"	○	●				
05	3/16" x 1/8"		○	●			
07	1/4" x 5/32"			○	●		
11	3/8" x 1/4"				○	●	
13	1/2" x 3/8"					○	●
19	3/4" x 5/8"						○
25	1" x 7/8"						○

○ Basic size ● With reducer

○ Basic size ● With reducer

Note 1) In the case of size 1, changing the tubing by reducing is not available.
Note 2) For details of applicable tubing sizes, refer to page 945.

Blanking plug

LQ-11P04 - []

Applicable fitting

Symbol	Size
11	1
12	2
13	3
14	4
15	5
16	6

Packaging

Symbol	Packaging
Nil	Clean packaging equivalent to ISO Class 5
1	Standard packaging equivalent to ISO Class 7

Applicable tubing size

Metric Size

Symbol	Applicable tubing size	Size					
		1	2	3	4	5	6
03	ø3 x ø2	○	●				
04	ø4 x ø3	○	●				
06	ø6 x ø4		○	●			
08	ø8 x ø6			○	●		
10	ø10 x ø8				○	●	
12	ø12 x ø10					○	●
19	ø19 x ø16						○
25	ø25 x ø22.5						○

Inch Size

Symbol	Applicable tubing size	Size					
		1	2	3	4	5	6
03	1/8" x 0.086"	○	●				
05	3/16" x 1/8"		○	●			
07	1/4" x 5/32"			○	●		
11	3/8" x 1/4"				○	●	
13	1/2" x 3/8"					○	●
19	3/4" x 5/8"						○
25	1" x 7/8"						○

○ Basic size ● With reducer

○ Basic size ● With reducer

Used to block fittings which are not being used.

Note) For details of the applicable tubing sizes, refer to page 945.

Tubing plug

LQ1-2CP - [] - [] Tubing plug will be a made-to-order product.

Size

Symbol	Size
1	1
2	2
3	3
4	4
5	5
6	6

Fitting type

Symbol	Type
CP	Tubing plug

Accessories/Packaging

Symbol	Accessories	Packaging
Nil	Without nut insert bush	Clean packaging equivalent to ISO Class 5
1	With nut insert bush	

Applicable tubing size

Metric Size

Symbol	Applicable tubing size	Size
03	ø3 x ø2	1
04	ø4 x ø3	
06	ø6 x ø4	2
08	ø8 x ø6	3
10	ø10 x ø8	3
12	ø12 x ø10	4
19	ø19 x ø16	5
25	ø25 x ø22	6

Inch Size

Symbol	Applicable tubing size	Size
03	1/8" x 0.086"	1
07	1/4" x 5/32"	2
11	3/8" x 1/4"	3
13	1/2" x 3/8"	4
19	3/4" x 5/8"	5
25	1" x 7/8"	6

Used to block tubing which are not being used.

Note) For details of the applicable tubing sizes, refer to page 945.

LVC
LVA
LVH
LVD
LVQ
LVP
LVW
LQ1
LQ3
LVN
LQHB
TL
TIL
TLM
TILM
TD
TID
TH
TIH

LQ1 Series Insertion Tool

Fittings

Changing tubing sizes

The tubing size can be changed within the same body class (body size) by replacing the nut and insert bushing. However, in case of class 1, the tubing cannot be changed by reducing.

Body class	Tubing O.D.														
	Metric sizes							Inch sizes							
	ø3	ø4	ø6	ø8	ø10	ø12	ø19	ø25	1/8"	3/16"	1/4"	3/8"	1/2"	3/4"	1"
1	○	○	—	—	—	—	—	—	○	—	—	—	—	—	—
2	●	●	○	—	—	—	—	—	●	●	○	—	—	—	—
3	—	—	●	●	○	—	—	—	—	—	●	○	—	—	—
4	—	—	—	—	●	○	—	—	—	—	—	●	○	—	—
5	—	—	—	—	—	●	○	—	—	—	—	—	●	○	—
6	—	—	—	—	—	—	●	○	—	—	—	—	—	●	○

Parts composition

	Component parts		
	Nut	Insert	Collar (Insert assembly)
○ Basic size	Yes	Yes	No
● Reducer type	Yes	Yes	Yes

⚠ Caution

1. Connect tubing with special tools

Refer to the pamphlet "High-Purity Fluoropolymer Fittings Hyper Fitting/LQ1, 2 Series Work Procedure Instructions" (M-E05-1) for connecting tubing and special tools. (Downloadable from our web site.)

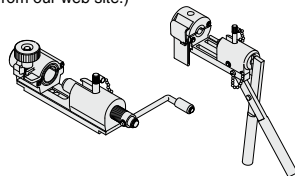

Changing the tubing size

Example) Changing the tubing from an O.D. 1/4" to O.D. 1/8" in LQ1 body class 2.

Prepare an insert bushing and nut for 1/8" O.D. tubing (LQ1-2U03) and change the tubing size.
(Refer to the section on how to order fitting parts.)

Note) Tubing is sold separately.

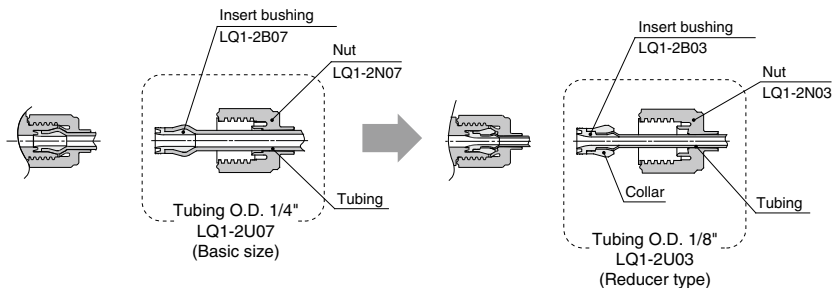

LVC
LVA
LVH
LVD
LVQ
LVP
LVW
LQ1
LQ3
LVN
LQHB
TL
TIL
TLM
TILM
TD
TID
TH
TIH

Fluoropolymer Fittings Hyper Fittings / Flare Type

LQ3 Series



How to Order

Threaded connection

LQ3 H 11 - M -

Fitting type

Symbol	Type
H	Connector
L	Elbow
B	Branch tee
R	Run tee

Nut material, packaging

Symbol	Nut material	Packaging
Nii	PFA	Clean packaging equivalent to ISO Class 5
1	PFA	Standard packaging equivalent to ISO Class 7
2	PVDF	Clean packaging equivalent to ISO Class 5
3	PVDF	Standard packaging equivalent to ISO Class 7

* LQ3H□: Nut material PVDF is not available.

Thread type

Symbol	Type
Nii	R, Rc
N	NPT

Piping type

Symbol	Type
M	Male
F	Female

Size combination

Size	No.	Applicable tubing size (mm)	Port size
1	1	4 x 3	1/8"
1	2	3 x 2	
2	1	6 x 4	1/8"
2	2		1/4"
3	1	10 x 8	1/8"
3	2	8 x 6	
3	3	10 x 8	1/4"
3	4	8 x 6	
3	5	10 x 8	3/8"
3	6	8 x 6	
3	8		1/2"
4	1	12 x 10	1/4"
4	2		3/8"
4	3		1/2"
4	4		3/4"
5	1	19 x 16	3/8"
5	2		1/2"
5	3		3/4"
6	1	25 x 22	1/2"
6	2		3/4"
6	3		1"

Size	No.	Applicable tubing size (mm)	Port size
1	A	1/8" x 0.086"	1/8"
2	A	1/4" x 5/32"	1/8"
2	B		1/4"
3	A	3/8" x 1/4"	1/8"
3	B		1/4"
3	C		3/8"
3	D		1/2"
4	A	1/2" x 3/8"	1/4"
4	B		3/8"
4	C		1/2"
4	D		3/4"
5	A	3/4" x 5/8"	3/8"
5	B		1/2"
5	C		3/4"
6	A	1" x 7/8"	1/2"
6	B		3/4"
6	C		1"
7*	A*	1 1/4" x 1.1"	3/4"
7*	B*		1"
7*	C*		1 1/4"
8*	C*	1 1/2" x 1.33"	1 1/2"

Note) For details of the applicable tubing sizes, refer to page 945.

* Fitting type H, piping type M: Male connector only.

How to Order

Tubing connection

LQ3 E 11 - □

Fitting type

Symbol	Type
E	Union elbow
T	Union tee
P	Panel mount union
U	Union

Nut material, packaging

Symbol	Nut material	Packaging
Nil	PFA	Clean packaging equivalent to ISO Class 5
1	PFA	Standard packaging equivalent to ISO Class 7
2	PVDF	Clean packaging equivalent to ISO Class 5
3	PVDF	Standard packaging equivalent to ISO Class 7

* LQ3□8A: Nut material PVDF is not available.

Size combination

Size	No.	Applicable tubing size (mm)
1	1	4 x 3
1	2	3 x 2
2	1	6 x 4
3	1	10 x 8
3	2	8 x 6
4	1	12 x 10
5	1	19 x 16
6	1	25 x 22

Size	Symbol	Applicable tubing size (inch)
1	A	1/8" x 0.086"
2	A	1/4" x 5/32"
3	A	3/8" x 1/4"
4	A	1/2" x 3/8"
5	A	3/4" x 5/8"
6	A	1" x 7/8"
7*	A*	1 1/4" x 1.1"
8*	A*	1 1/2" x 1.33"

Note) For details of the applicable tubing sizes, refer to page 945.

* P: Without panel mounting

LVC
LVA
LVB
LVD
LVE
LVM
LVP
LWV
LQ1
LQ3
LVN
LQHB
TL
TIL
TLM
TILM
TD
TID
TH
TIH

LQ3 Series



⚠ Specific Product Precautions

Be sure to read this before handling the products. Refer to back page 50 for Safety Instructions.

Piping

⚠ Caution

1. Connect tubing with special tools

Please refer to the LQ3 series mounting method in "High Purity Fluoropolymer Fittings: Hyper Fitting/Flare Type" (M-E06-4) for tubing connection and special tools. (Downloadable from our web site.)

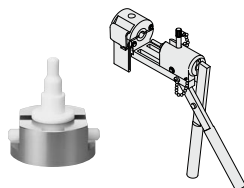

2. Tighten the nut until it touches the end surface of the body, and then tighten it an additional 1/8 turn. If the nut won't turn any further, then it means a sufficient tightening has occurred. Refer to the proper tightening torques shown below.

Tightening torque for piping

Body class	Torque (N·m)
1	0.7 to 0.9
2	1.6 to 1.8
3	3.2 to 3.5
4	5.0 to 5.3
5	10.0 to 10.5
6	22.5 to 23.0
7	23.0 to 26.5

Specifications

Feature	Model	LQ3□10	LQ3□20	LQ3□30	LQ3□40	LQ3□50	LQ3□60	LQ3□70
Material		New PFA						
Maximum operating pressure (at 20°C)		1.0 MPa						
Proof pressure		Refer to the withstand pressure and heat resistance performance data.						
Operating temperature	Nut material PVDF	0 to 150°C						
	Nut material PFA	0 to 200°C						

Withstand Pressure and Heat Resistance Performance

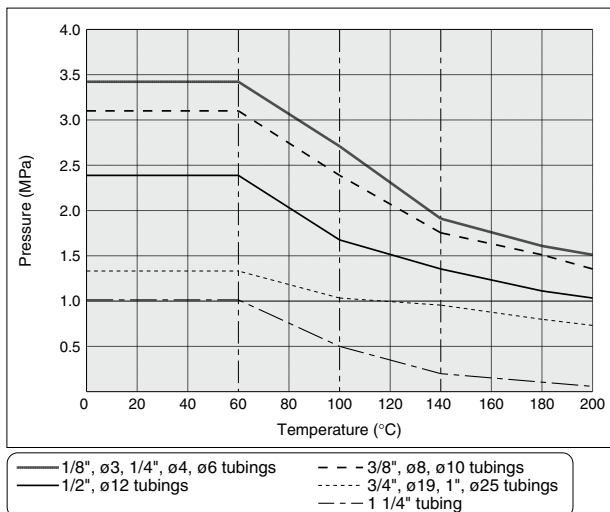

Dimensions

Male connector: LQ3H-M

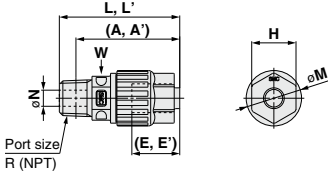

(A,A'): Reference dimension after installation
(E,E'): Reference dimension for the inserted tubing from the end surface of the nut
(A),L',E': Nut material PVDF dimensions
W: Width across flats dimension

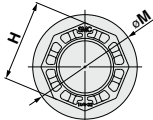

Class 7, 8

Metric Size

Model	Applicable tubing O.D.	Connection threads R/NPT	A	A'	E	E'	H	L	L'	M	W	N	Min. port size	
LQ3H11-M□	ø4													
LQ3H12-M□	ø3	1/8"	29.5	28.5	10	9	11	33.5	32.5	14	10	4	2.5	
LQ3H21-M□	ø6	1/8"	39.5	38.5	17	16	16	43.5	42.5	20	14	4	6	
LQ3H22-M□		1/4"	37.5	36.5									6	
LQ3H31-M□	ø10	1/8"	51	48	22.5	19.5	21	55	52	25	18	4.4	4.4	
LQ3H32-M□	ø8													
LQ3H33-M□	ø10	1/4"	49	46	22.5	19.5	21	55	52	25	18	6.4	6.4	
LQ3H34-M□	ø8													
LQ3H35-M□	ø10											10	7.5	
LQ3H36-M□	ø8	3/8"	48.5	45.5	24	22	24	64	62	29	22	10	6.4	
LQ3H38-M□		1/2"	54	51									62	59
LQ3H41-M□	ø12	1/4"	58	56	24	22	24	64	62	29	22	16	6	
LQ3H42-M□		3/8"	69.5	67									8	8
LQ3H43-M□		1/2"	56	54									9.5	9.5
LQ3H44-M□		3/4"	59.8	57.6									16	16
LQ3H51-M□	ø19	3/8"	69.5	67	26.5	24	32	76	73.5	37	30	10	10	
LQ3H52-M□		1/2"	68	65.5									16	16
LQ3H53-M□		3/4"	66.5	64									16	16
LQ3H61-M□	ø25	1/2"	80	76	30	26	41	88	84	49	36	16	10	
LQ3H62-M□		3/4"	78.5	74.5									16	16
LQ3H63-M□		1"	77.5	73.5									22	22

Inch Size

Model	Applicable tubing O.D.	Connection threads R/NPT	A	A'	E	E'	H	L	L'	M	W	N	Min. port size	
LQ3H1A-M□	1/8"	1/8"	29.5	28.5	10	9	11	33.5	32.5	14	10	4	2	
LQ3H2A-M□	1/4"	1/8"	39.5	38.5	17	16	16	43.5	42.5	20	14	4	4	
LQ3H2B-M□		1/4"	37.5	36.5									6	
LQ3H3A-M□	3/8"	1/8"	51	48	22.5	19.5	21	55	52	25	18	4.4	4.4	
LQ3H3B-M□		1/4"	49	46									6.4	
LQ3H3C-M□		3/8"	48.5	45.5									10	
LQ3H3D-M□		1/2"	54	51									62	59
LQ3H4A-M□	1/2"	1/4"	58	56	24.5	22.5	24	64	62	29	22	6	6	
LQ3H4B-M□		3/8"	69.5	67									8	8
LQ3H4C-M□		1/2"	56	54									9.5	9.5
LQ3H4D-M□		3/4"	59.8	57.6									16	16
LQ3H5A-M□	3/4"	3/8"	69.5	67	26.5	24	32	76	73.5	37	30	10	10	
LQ3H5B-M□		1/2"	68	65.5									16	16
LQ3H5C-M□		3/4"	66.5	64									16	16
LQ3H6A-M□	1"	1/2"	80	76	30	26	41	88	84	49	36	10	10	
LQ3H6B-M□		3/4"	78.5	74.5									16	16
LQ3H6C-M□		1"	77.5	73.5									22	22
LQ3H7A-M□	1 1/4"	3/4"	96.5	96.5	35	35	50	106	106	64	46	22	22	
LQ3H7B-M□		1"	95.5	95.5									28.5	28.5
LQ3H7C-M□		1 1/4"	93.3	93.3									22	22
LQ3H8C-M□	1 1/2"	1 1/2"	101.3	—	39	—	60	114	—	77	55	36	36	

LVC

LVA

LVB

LVD

LQV

LVP

LWV

LQ1

LQ3

LQV

LQHB

TL

TIL

TLM

TID

TIH

LQ3 Series

Dimensions

Female connector: LQ3H-F

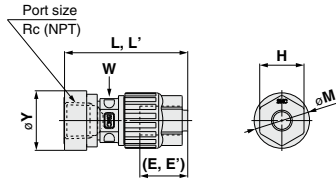

(E,E'): Reference dimension for the inserted tubing from the end surface of the nut
 (E'),L': Nut material PVDF dimensions
 W: Width across flats dimension

Metric Size

Model	Applicable tubing O.D.	Connection threads Rc/NPT	E	E'	H	L	L'	M	Min. port size	W	Y
LQ3H11-F□	ø4								2.5		
LQ3H12-F□	ø3	1/8"	10	9	11	35	34	14	2	10	18.5
LQ3H21-F□	ø6	1/8"				40	39				18.5
LQ3H22-F□		1/4"				45	44	20	4	14	21.5
LQ3H31-F□	ø10	1/8"				50.5	47.5		7.5		18.5
LQ3H32-F□	ø8								6.4		
LQ3H33-F□	ø10		22.5	19.5	21	55	52	25	7.5	18	21.5
LQ3H34-F□	ø8	1/4"							6.4		
LQ3H35-F□	ø10					55.5	52.5		7.5		25
LQ3H36-F□	ø8	3/8"							6.4		
LQ3H41-F□		1/4"				55.5	53				21.5
LQ3H42-F□	ø12	3/8"	24	22	24	58	56	29	9.5	22	25
LQ3H43-F□		1/2"				66	64				29.5
LQ3H51-F□		3/8"				67	64.5		14		25
LQ3H52-F□	ø19	1/2"	26.5	24	32	72	69.5	37		30	29.5
LQ3H53-F□		3/4"				73.5	71		16		36
LQ3H61-F□		1/2"				81.5	77.5		17.5		29.5
LQ3H62-F□	ø25	3/4"	30	26	41	83	79	49		36	36
LQ3H63-F□		1"				90.5	86.5		22		44.5

Inch Size

Model	Applicable tubing O.D.	Connection threads Rc/NPT	E	E'	H	L	L'	M	Min. port size	W	Y
LQ3H1A-F□	1/8"	1/8"	10	9	11	35	34	14	2	10	18.5
LQ3H2A-F□	1/4"	1/8"				40	39				18.5
LQ3H2B-F□		1/4"				45	44	20	4	14	21.5
LQ3H3A-F□		1/8"				50.5	47.5				18.5
LQ3H3B-F□	3/8"	1/4"	22.5	19.5	21	55	52	25	6.4	18	21.5
LQ3H3C-F□		3/8"				55.5	52.5				25
LQ3H4A-F□		1/4"				55.5	53				21.5
LQ3H4B-F□	1/2"	3/8"	24.5	22.5	24	58	56	29	9.5	22	25
LQ3H4C-F□		1/2"				66	64				29.5
LQ3H5A-F□		3/8"				67	64.5		14		25
LQ3H5B-F□	3/4"	1/2"	26.5	24	32	72	69.5	37		30	29.5
LQ3H5C-F□		3/4"				73.5	71		16		36
LQ3H6A-F□		1/2"				81.5	77.5		17.5		29.5
LQ3H6B-F□	1"	3/4"	30	26	41	83	79	49		36	36
LQ3H6C-F□		1"				90.5	86.5		22		44.5

Dimensions

Male elbow: LQ3L-M

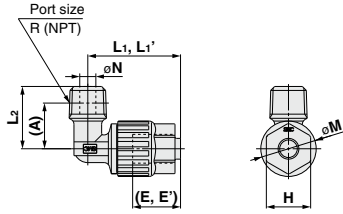

(A): Reference dimension after installation
(E,E'): Reference dimension for the inserted tubing from the end surface of the nut
(E),L1': Nut material PVDF dimensions

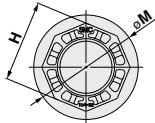

Class 7

Metric Size

Model	Applicable tubing O.D.	Connection threads R/NPT	A	E	E'	H	L ₁	L ₁ '	L ₂	M	N	Min. port size
LQ3L11-M□	ø4											
LQ3L12-M□	ø3	1/8"	12.5	10	9	11	26	25	16.5	14	4	2.5
LQ3L21-M□	ø6	1/8"	18.5	17	16	16	33.5	32.5	22.5	20	4	4
LQ3L22-M□		1/4"	16.5								6	
LQ3L31-M□	ø10	1/8"	24								4.4	4.4
LQ3L32-M□	ø8										6.4	6.4
LQ3L33-M□	ø10	1/4"	22	22.5	19.5	21	46	43	28	25	6.4	6.4
LQ3L34-M□	ø8										10	7.5
LQ3L35-M□	ø10	3/8"	21.5								10	7.5
LQ3L36-M□		1/2"	24.5				47.5	44.5	32.5		9.5	6.4
LQ3L38-M□	ø8										9.5	6.4
LQ3L41-M□		1/4"	27								6	6
LQ3L42-M□	ø12	3/8"	26.5	24	22	24	54.5	52.5	33	29	8	8
LQ3L43-M□		1/2"	25								9.5	9.5
LQ3L51-M□		3/8"	33.5								8	8
LQ3L52-M□	ø19	1/2"	32	26.5	24	32	64	61.5	40	37	10	10
LQ3L53-M□		3/4"	30.5								16	16
LQ3L61-M□		1/2"	38								10	10
LQ3L62-M□	ø25	3/4"	36.5	30	26	41	77	73	46	49	16	16
LQ3L63-M□		1"	35.5								22	22

Inch Size

Model	Applicable tubing O.D.	Connection threads R/NPT	A	E	E'	H	L ₁	L ₁ '	L ₂	M	N	Min. port size
LQ3L1A-M□	1/8"	1/8"	12.5	10	9	11	26	25	16.5	14	4	2
LQ3L2A-M□	1/4"	1/8"	18.5	17	16	16	33.5	32.5	22.5	20	4	4
LQ3L2B-M□		1/4"	16.5								6	
LQ3L3A-M□		1/8"	24								4.4	4.4
LQ3L3B-M□	3/8"	1/4"	22	22.5	19.5	21	46	43	28	25	6.4	6.4
LQ3L3C-M□		3/8"	21.5								10	10
LQ3L3D-M□		1/2"	24.5				47.5	44.5	32.5		9.5	6.4
LQ3L4A-M□		1/4"	27								6	6
LQ3L4B-M□	1/2"	3/8"	26.5	24.5	22.5	24	54.5	52.5	33	29	8	8
LQ3L4C-M□		1/2"	25								9.5	9.5
LQ3L5A-M□		3/8"	33.5								8	8
LQ3L5B-M□	3/4"	1/2"	32	26.5	24	32	64	61.5	40	37	10	10
LQ3L5C-M□		3/4"	30.5								16	16
LQ3L6A-M□		1/2"	38								10	10
LQ3L6B-M□	1"	3/4"	36.5	30	26	41	77	73	46	49	16	16
LQ3L6C-M□		1"	35.5								22	22

LVC

LVA

LVB

LVD

LVQ

LVP

LWV

LQ1

LQ3

LVN

LQHB

TL

TIL

TLM

TILM

TD

TID

TH

TIH

LQ3 Series

Dimensions

Female elbow: LQ3L-F

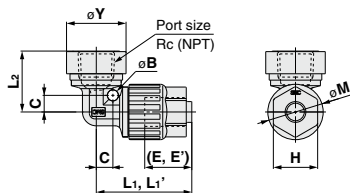

(E, E'): Reference dimension for the inserted tubing from the end surface of the nut
(E'), L₁': Nut material PVDF dimensions

Metric Size

Model	Applicable tubing O.D.	Connection threads Rc/NPT	B	C	E	E'	H	L ₁	L ₁ '	L ₂	M	Min. port size	Y
LQ3L11-F□	ø4											2.5	
LQ3L12-F□	ø3	1/8"	3.5	4.8	10	9	11	28.5	27.5	19.5	14	2	18.5
LQ3L21-F□	ø6	1/8"								20		4	18.5
LQ3L22-F□		1/4"	4	6	17	16	16	34.5	33.5	22	20	4	21.5
LQ3L31-F□	ø10	1/8"								23		7.5	18.5
LQ3L32-F□	ø8											6.4	
LQ3L33-F□	ø10											7.5	21.5
LQ3L34-F□	ø8	1/4"	5	9	22.5	19.5	21	47.5	44.5	24	25	6.4	
LQ3L35-F□	ø10											7.5	25
LQ3L36-F□	ø8	3/8"								25.5		6.4	
LQ3L41-F□		1/4"								23.5			21.5
LQ3L42-F□	ø12	3/8"	6	10	24	22	24	52.5	50.5	26	29	9.5	25
LQ3L43-F□		1/2"								30			29.5
LQ3L51-F□		3/8"								30.5		14	25
LQ3L52-F□	ø19	1/2"	7	14	26.5	24	32	64	61.5	35.5	37	16	29.5
LQ3L53-F□		3/4"								37			36
LQ3L61-F□		1/2"								41		17.5	29.5
LQ3L62-F□	ø25	3/4"	8	18	30	26	41	78	74	42.5	49	22	36
LQ3L63-F□		1"								46			44.5

Inch Size

Model	Applicable tubing O.D.	Connection threads Rc/NPT	B	C	E	E'	H	L ₁	L ₁ '	L ₂	M	Min. port size	Y
LQ3L1A-F□	1/8"	1/8"	3.5	4.8	10	9	11	28.5	27.5	19.5	14	2	18.5
LQ3L2A-F□	1/4"	1/8"								20		4	18.5
LQ3L2B-F□		1/4"	4	6	17	16	16	34.5	33.5	22	20	4	21.5
LQ3L3A-F□		1/8"								23			18.5
LQ3L3B-F□	3/8"	1/4"	5	9	22.5	19.5	21	47.5	44.5	24	25	6.4	21.5
LQ3L3C-F□		3/8"								25.5			25
LQ3L4A-F□		1/4"								23.5			21.5
LQ3L4B-F□	1/2"	3/8"	6	10	24.5	22.5	24	52.5	50.5	26	29	9.5	25
LQ3L4C-F□		1/2"								30			29.5
LQ3L5A-F□		3/8"								30.5		14	25
LQ3L5B-F□	3/4"	1/2"	7	14	26.5	24	32	64	61.5	35.5	37	16	29.5
LQ3L5C-F□		3/4"								37			36
LQ3L6A-F□		1/2"								41		17.5	29.5
LQ3L6B-F□	1"	3/4"	8	18	30	26	41	78	74	42.5	49	22	36
LQ3L6C-F□		1"								46			44.5

Dimensions

Male branch tee: LQ3B-M

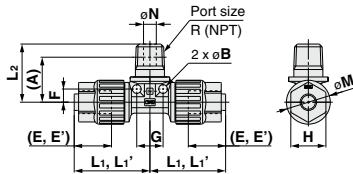

(A): Reference dimension after installation
(E,E'): Reference dimension for the inserted tubing from the end surface of the nut
E',L1': Nut material PVDF dimensions

Metric Size

Model	Applicable tubing O.D.	Connection threads R/NPT	A	B	E	E'	F	G	H	L ₁	L ₁ '	L ₂	M	N	Min. port size
LQ3B11-M□	ø4														2.5
LQ3B12-M□	ø3	1/8"	15	3.5	10	9	4.8	9.5	11	28.5	27.5	19	14	4	2
LQ3B21-M□	ø6	1/8"	19.5									23.5		4	
LQ3B22-M□		1/4"	20.5	4	17	16	6	12	16	34.5	33.5	26.5	20	6	4
LQ3B31-M□	ø10	1/8"	22.5									26.5		4	4
LQ3B32-M□	ø8														
LQ3B33-M□	ø10	1/4"	23.5	5	22.5	19.5	9	18	21	47.5	44.5	29.5	25	6.4	6.4
LQ3B34-M□	ø8														
LQ3B35-M□	ø10											30.5		10	7.5
LQ3B36-M□	ø8	3/8"	24											6.4	6.4
LQ3B41-M□		1/4"	27									33		6	6
LQ3B42-M□	ø12	3/8"	27.5	6	24	22	10	20	24	52.5	50.5	34	29	9.5	9.5
LQ3B43-M□		1/2"	29									37			
LQ3B51-M□		3/8"	32.5									39			
LQ3B52-M□	ø19	1/2"	34	7	26.5	24	14	28	32	64	61.5	42	37	10	10
LQ3B53-M□		3/4"	34.5									44		16	16
LQ3B61-M□		1/2"	42									50		10	10
LQ3B62-M□	ø25	3/4"	42.5	8	30	26	18	36	41	78	74	52	49	16	16
LQ3B63-M□		1"										53		22	22

Inch Size

Model	Applicable tubing O.D.	Connection threads R/NPT	A	B	E	E'	F	G	H	L ₁	L ₁ '	L ₂	M	N	Min. port size
LQ3B1A-M□	1/8"	1/8"	15	3.5	10	9	4.8	9.5	11	28.5	27.5	19	14	4	2
LQ3B2A-M□	1/4"	1/8"	19.5									23.5		4	
LQ3B2B-M□		1/4"	20.5	4	17	16	6	12	16	34.5	33.5	26.5	20	6	4
LQ3B3A-M□		1/8"	22.5									26.5		4	4
LQ3B3B-M□	3/8"	1/4"	23.5	5	22.5	19.5	9	18	21	47.5	44.5	29.5	25	6.4	6.4
LQ3B3C-M□		3/8"	24									30.5		10	
LQ3B4A-M□		1/4"	27									33		6	6
LQ3B4B-M□	1/2"	3/8"	27.5	6	24.5	22.5	10	20	24	52.5	50.5	34	29	9.5	9.5
LQ3B4C-M□		1/2"	29									37			
LQ3B5A-M□		3/8"	32.5									39			
LQ3B5B-M□	3/4"	1/2"	34	7	26.5	24	14	28	32	64	61.5	42	37	10	10
LQ3B5C-M□		3/4"	34.5									44		16	16
LQ3B6A-M□		1/2"	42									50		10	10
LQ3B6B-M□	1"	3/4"	42.5	8	30	26	18	36	41	78	74	52	49	16	16
LQ3B6C-M□		1"										53		22	22

LVC

LVA

LVB

LVD

LQV

LVP

LQV

LQV

LQV

LQV

LQV

LQV

LQV

LQV

LQV

LQV

LQV

LQV

LQV

LQV

LQV

LQV

LQV

LQV

LQV

LQV

LQV

LQV

LQV

LQV

LQ3 Series

Dimensions

Female branch tee: LQ3B-F

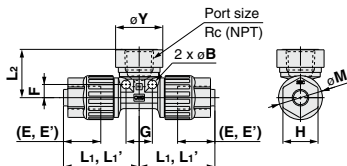

(E,E'): Reference dimension for the inserted tubing from the end surface of the nut
(E),L1': Nut material PVDF dimensions

Metric Size

Model	Applicable tubing O.D.	Connection threads Rc/NPT	B	E	E'	F	G	H	L ₁	L ₁ '	L ₂	M	Min. port size	Y
LQ3B11-F□	ø4												2.5	
LQ3B12-F□	ø3	1/8"	3.5	10	9	4.8	9.5	11	28.5	27.5	19.5	14	2	18.5
LQ3B21-F□	ø6	1/8"									20		18.5	
LQ3B22-F□		1/4"	4	17	16	6	12	16	34.5	33.5	22	20	4	21.5
LQ3B31-F□	ø10	1/8"									23		7.5	18.5
LQ3B32-F□	ø8												6.4	
LQ3B33-F□	ø10	1/4"	5	22.5	19.5	9	18	21	47.5	44.5	24	25	7.5	21.5
LQ3B34-F□	ø8												6.4	
LQ3B35-F□	ø10	3/8"									25.5		7.5	25
LQ3B36-F□	ø8												6.4	
LQ3B41-F□		1/4"									23.5			21.5
LQ3B42-F□	ø12	3/8"	6	24	22	10	20	24	52.5	50.5	26	29	9.5	25
LQ3B43-F□		1/2"									30			29.5
LQ3B51-F□		3/8"									30.5		14	25
LQ3B52-F□	ø19	1/2"	7	26.5	24	14	28	32	64	61.5	35.5	37	16	29.5
LQ3B53-F□		3/4"									37			36
LQ3B61-F□		1/2"									41		17.5	29.5
LQ3B62-F□	ø25	3/4"	8	30	26	18	36	41	78	74	42.5	49	22	36
LQ3B63-F□		1"									46			44.5

Inch Size

Model	Applicable tubing O.D.	Connection threads Rc/NPT	B	E	E'	F	G	H	L ₁	L ₁ '	L ₂	M	Min. port size	Y
LQ3B1A-F□	1/8"	1/8"	3.5	10	9	4.8	9.5	11	28.5	27.5	19.5	14	2	18.5
LQ3B2A-F□	1/4"	1/8"									20		4	18.5
LQ3B2B-F□		1/4"	4	17	16	6	12	16	34.5	33.5	22	20	4	21.5
LQ3B3A-F□		1/8"									23			18.5
LQ3B3B-F□	3/8"	1/4"	5	22.5	19.5	9	18	21	47.5	44.5	24	25	6.4	21.5
LQ3B3C-F□		3/8"									25.5			25
LQ3B4A-F□		1/4"									23.5			21.5
LQ3B4B-F□	1/2"	3/8"	6	24.5	22.5	10	20	24	52.5	50.5	26	29	9.5	25
LQ3B4C-F□		1/2"									30			29.5
LQ3B5A-F□		3/8"									30.5		14	25
LQ3B5B-F□	3/4"	1/2"	7	26.5	24	14	28	32	64	61.5	35.5	37	16	29.5
LQ3B5C-F□		3/4"									37			36
LQ3B6A-F□		1/2"									41		17.5	29.5
LQ3B6B-F□	1"	3/4"	8	30	26	18	36	41	78	74	42.5	49	22	36
LQ3B6C-F□		1"									46			44.5

Dimensions

Male run tee: LQ3R-M

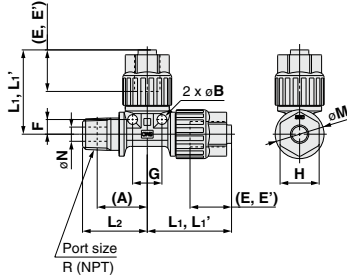

(A): Reference dimension after installation
(E,E'): Reference dimension for the inserted tubing from the end surface of the nut
(E'),L': Nut material PVDF dimensions

Metric Size

Model	Applicable tubing O.D.	Connection threads R/NPT	A	B	E	E'	F	G	H	L ₁	L ₁ '	L ₂	M	N	Min. port size
LQ3R11-M□	ø4														
LQ3R12-M□	ø3	1/8"	15	3.5	10	9	4.8	9.5	11	28.5	27.5	19	14	4	2.5
LQ3R21-M□	ø6	1/8"	19.5									23.5		4	4
LQ3R22-M□		1/4"	20.5	4	17	16	6	12	16	34.5	33.5	26.5	20	6	2
LQ3R31-M□	ø10	1/8"	22.5									26.5		4	4
LQ3R32-M□	ø8														
LQ3R33-M□	ø10														
LQ3R34-M□	ø8	1/4"	23.5	5	22.5	19.5	9	18	21	47.5	44.5	29.5	25	6.4	6.4
LQ3R35-M□	ø10														
LQ3R36-M□	ø8	3/8"	24									30.5		10	7.5
LQ3R41-M□		1/4"	27									33		6	6
LQ3R42-M□	ø12	3/8"	27.5	6	24	22	10	20	24	52.5	50.5	34	29	9.5	9.5
LQ3R43-M□		1/2"	29									37			
LQ3R51-M□		3/8"	32.5									39			
LQ3R52-M□	ø19	1/2"	34	7	26.5	24	14	28	32	64	61.5	42	37	10	10
LQ3R53-M□		3/4"	34.5									44		16	16
LQ3R61-M□		1/2"	42									50		10	10
LQ3R62-M□	ø25	3/4"	42.5	8	30	26	18	36	41	78	74	52	49	16	16
LQ3R63-M□		1"										53		22	22

Inch Size

Model	Applicable tubing O.D.	Connection threads R/NPT	A	B	E	E'	F	G	H	L ₁	L ₁ '	L ₂	M	N	Min. port size
LQ3R1A-M□	1/8"	1/8"	15	3.5	10	9	4.8	9.5	11	28.5	27.5	19	14	4	2
LQ3R2A-M□	1/4"	1/8"	19.5									23.5		4	4
LQ3R2B-M□		1/4"	20.5	4	17	16	6	12	16	34.5	33.5	26.5	20	6	2
LQ3R3A-M□		1/8"	22.5									26.5		4	4
LQ3R3B-M□	3/8"	1/4"	23.5	5	22.5	19.5	9	18	21	47.5	44.5	29.5	25	6.4	6.4
LQ3R3C-M□		3/8"	24									30.5		10	
LQ3R4A-M□		1/4"	27									33		6	6
LQ3R4B-M□	1/2"	3/8"	27.5	6	24.5	22.5	10	20	24	52.5	50.5	34	29	9.5	9.5
LQ3R4C-M□		1/2"	29									37			
LQ3R5A-M□		3/8"	32.5									39			
LQ3R5B-M□	3/4"	1/2"	34	7	26.5	24	14	28	32	64	61.5	42	37	10	10
LQ3R5C-M□		3/4"	34.5									44		16	16
LQ3R6A-M□		1/2"	42									50		10	10
LQ3R6B-M□	1"	3/4"	42.5	8	30	26	18	36	41	78	74	52	49	16	16
LQ3R6C-M□		1"										53		22	22

LVC

LVA

LVH

LVD

LVQ

LVP

LVW

LQ1

LQ3

LVN

LQHB

TL

TIL

TLM

TILM

TD

TID

TH

TIH

LQ3 Series

Dimensions

Female run tee: LQ3R-F

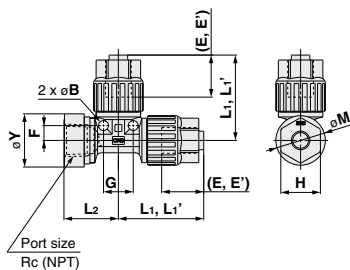

(E, E'): Reference dimension for the inserted tubing from the end surface of the nut
(E'), L1': Nut material PVDF dimensions

Metric Size

Model	Applicable tubing O.D.	Connection threads Rc/NPT	B	E	E'	F	G	H	L ₁	L ₁ '	L ₂	M	Min. port size	Y
LQ3R11-F□	ø4	1/8"	3.5	10	9	4.8	9.5	11	28.5	27.5	19.5	14	2.5	18.5
LQ3R12-F□	ø3												2	
LQ3R21-F□	ø6	1/8"	4	17	16	6	12	16	34.5	33.5	20	20	4	18.5
LQ3R22-F□		1/4"											2	
LQ3R31-F□	ø10	1/8"	5	22.5	19.5	9	18	21	47.5	44.5	23	25	7.5	18.5
LQ3R32-F□	ø8												6.4	
LQ3R33-F□	ø10	1/4"	5	22.5	19.5	9	18	21	47.5	44.5	24	25	7.5	21.5
LQ3R34-F□	ø8												6.4	
LQ3R35-F□	ø10	3/8"	5	22.5	19.5	9	18	21	47.5	44.5	25.5	25	7.5	25
LQ3R36-F□	ø8												6.4	
LQ3R41-F□	ø12	1/4"	6	24	22	10	20	24	52.5	50.5	26	29	9.5	25
LQ3R42-F□	3/8"	30											29.5	
LQ3R43-F□	1/2"	30											29.5	
LQ3R51-F□	ø19	3/8"	7	26.5	24	14	28	32	64	61.5	30.5	37	14	25
LQ3R52-F□	1/2"	37											29.5	
LQ3R53-F□	3/4"	37											36	
LQ3R61-F□	ø25	1/2"	8	30	26	18	36	41	78	74	41	49	17.5	29.5
LQ3R62-F□	3/4"	42.5											36	
LQ3R63-F□	1"	46											44.5	

Inch Size

Model	Applicable tubing O.D.	Connection threads Rc/NPT	B	E	E'	F	G	H	L ₁	L ₁ '	L ₂	M	Min. port size	Y	
LQ3R1A-F□	1/8"	1/8"	3.5	10	9	4.8	9.5	11	28.5	27.5	19.5	14	2	18.5	
LQ3R2A-F□	1/4"	1/8"	4	17	16	6	12	16	34.5	33.5	20	20	4	18.5	
LQ3R2B-F□		1/4"											2		
LQ3R3A-F□	3/8"	1/8"	5	22.5	19.5	9	18	21	47.5	44.5	23	25	6.4	21.5	
LQ3R3B-F□		1/4"											25		25
LQ3R3C-F□	3/8"	23.5	21.5												
LQ3R4A-F□	1/2"	1/4"	6	24.5	22.5	10	20	24	52.5	50.5	26	29	9.5	25	
LQ3R4B-F□	3/8"	30											29.5		
LQ3R4C-F□	1/2"	30											29.5		
LQ3R5A-F□	3/4"	3/8"	7	26.5	24	14	28	32	64	61.5	30.5	37	14	25	
LQ3R5B-F□		1/2"											37		29.5
LQ3R5C-F□		3/4"											37		36
LQ3R6A-F□	1"	1/2"	8	30	26	18	36	41	78	74	41	49	17.5	29.5	
LQ3R6B-F□		3/4"											42.5		36
LQ3R6C-F□		1"											46		44.5

Dimensions

Union elbow: LQ3E

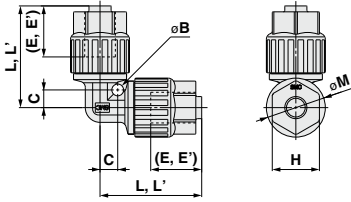

(E,E'): Reference dimension for the inserted tubing from the end surface of the nut
(E',L'): Nut material PVDF dimensions

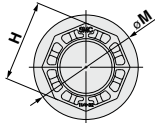

Class 7, 8

Metric Size

Model	Applicable tubing O.D.	B	C	E	E'	H	L	L'	M	Min. port size
LQ3E11	ø4									2.5
LQ3E12	ø3	3.5	4.8	10	9	11	28.5	27.5	14	2
LQ3E21	ø6	4	6	17	16	16	34.5	33.5	20	4
LQ3E31	ø10									7.5
LQ3E32	ø8	5	9	22.5	19.5	21	47.5	44.5	25	6.4
LQ3E41	ø12	6	10	24	22	24	52.5	50.5	29	9.5
LQ3E51	ø19	7	14	26.5	24	32	64	61.5	37	16
LQ3E61	ø25	8	18	30	26	41	78	74	49	22

Inch Size

Model	Applicable tubing O.D.	B	C	E	E'	H	L	L'	M	Min. port size
LQ3E1A	1/8"	3.5	4.8	10	9	11	28.5	27.5	14	2
LQ3E2A	1/4"	4	6	17	16	16	34.5	33.5	20	4
LQ3E3A	3/8"	5	9	22.5	19.5	21	47.5	44.5	25	6.4
LQ3E4A	1/2"	6	10	24.5	22.5	24	52.5	50.5	29	9.5
LQ3E5A	3/4"	7	14	26.5	24	32	64	61.5	37	16
LQ3E6A	1"	8	18	30	26	41	78	74	49	22
LQ3E7A	1 1/4"	9	22	35	35	50	92.5	92.5	64	28
LQ3E8A	1 1/2"	11	28.5	39	—	60	100.5	—	77	36

Union tee: LQ3T

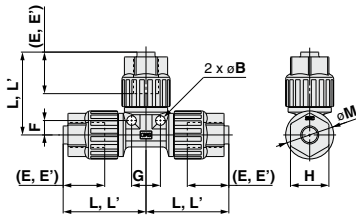

(E,E'): Reference dimension for the inserted tubing from the end surface of the nut
(E',L'): Nut material PVDF dimensions

Metric Size

Model	Applicable tubing O.D.	B	E	E'	F	G	H	L	L'	M	Min. port size
LQ3T11	ø4										2.5
LQ3T12	ø3	3.5	10	9	4.8	9.5	11	28.5	27.5	14	2
LQ3T21	ø6	4	17	16	6	12	16	34.5	33.5	20	4
LQ3T31	ø10										7.5
LQ3T32	ø8	5	22.5	19.5	9	18	21	47.5	44.5	25	6.4
LQ3T41	ø12	6	24	22	10	20	24	52.5	50.5	29	9.5
LQ3T51	ø19	7	26.5	24	14	28	32	64	61.5	37	16
LQ3T61	ø25	8	30	26	18	36	41	78	74	49	22

Inch Size

Model	Applicable tubing O.D.	B	E	E'	F	G	H	L	L'	M	Min. port size
LQ3T1A	1/8"	3.5	10	9	4.8	9.5	11	28.5	27.5	14	2
LQ3T2A	1/4"	4	17	16	6	12	16	34.5	33.5	20	4
LQ3T3A	3/8"	5	22.5	19.5	9	18	21	47.5	44.5	25	6.4
LQ3T4A	1/2"	6	24.5	22.5	10	20	24	52.5	50.5	29	9.5
LQ3T5A	3/4"	7	26.5	24	14	28	32	64	61.5	37	16
LQ3T6A	1"	8	30	26	18	36	41	78	74	49	22
LQ3T7A	1 1/4"	9	35	35	22	44	50	92.5	92.5	64	28
LQ3T8A	1 1/2"	11	39	—	28.5	57	60	100.5	—	77	36

LVC
LVA
LVH
LVD
LVQ
LVP
LVW
LQ1
LQ3
LVN
LQHB
TL
TIL
TLM
TILM
TD
TID
TH
TIH

LQ3 Series

Dimensions

Panel mount union: LQ3P

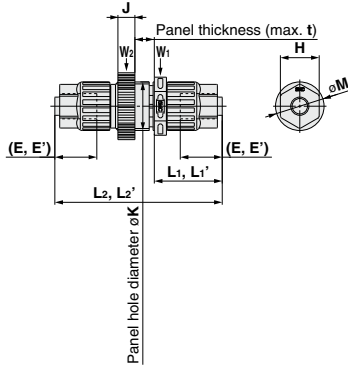

(E,E'): Reference dimension for the inserted tubing from the end surface of the nut
 (E'),L1',L2': Nut material PVDF dimensions
 W: Width across flats dimension

Metric Size

Model	Applicable tubing O.D.	E	E'	H	J	K	L ₁	L ₁ '	L ₂	L ₂ '	M	Min. port size	t	W ₁	W ₂	
LQ3P11	ø4											2.5				
LQ3P12	ø3	10	9	11	6	14.5	23.5	22.5	58	56	14	2	8	16	17	
LQ3P21	ø6	17	16	16	7	20.5	28	27	69	67	20	4	8	21	24	
LQ3P31	ø10											7.5				
LQ3P32	ø8	22.5	19.5	21	7	24.5	39	36	89	83	25	6.4	8	26	28	
LQ3P41	ø12	24	22	24	9	30.5	44.5	42.5	100	96	29	9.5	8	32	36	
LQ3P51	ø19	26.5	24	32	9	36.5	50.5	48	117	112	37	16	13	41	43	
LQ3P61	ø25	30	26	41	10	48.5	60	56	136	127.5	49	22	13	50	55	

Inch Size

Model	Applicable tubing O.D.	E	E'	H	J	K	L ₁	L ₁ '	L ₂	L ₂ '	M	Min. port size	t	W ₁	W ₂
LQ3P1A	1/8"	10	9	11	6	14.5	23.5	22.5	58	56	14	2	8	16	17
LQ3P2A	1/4"	17	16	16	7	20.5	28	27	69	67	20	4	8	21	24
LQ3P3A	3/8"	22.5	19.5	21	7	24.5	39	36	89	83	25	6.4	8	26	28
LQ3P4A	1/2"	24.5	22.5	24	9	30.5	44.5	42.5	100	96	29	9.5	8	32	36
LQ3P5A	3/4"	26.5	24	32	9	36.5	50.5	48	117	112	37	16	13	41	43
LQ3P6A	1"	30	26	41	10	48.5	60	56	136	127.5	49	22	13	50	55

Union: LQ3U

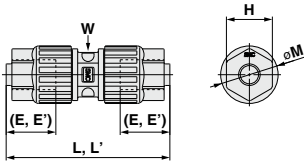

(E,E'): Reference dimension for the inserted tubing from the end surface of the nut
 (E'),L': Nut material PVDF dimensions
 W: Width across flats dimension

Metric Size

Model	Applicable tubing O.D.	E	E'	H	L	L'	M	Min. port size	W
LQ3U11	ø4							2.5	
LQ3U12	ø3	10	9	11	46.5	44.5	14	2	10
LQ3U21	ø6	17	16	16	57	55	20	4	14
LQ3U31	ø10							7.5	
LQ3U32	ø8	22.5	19.5	21	79	73	25	6.4	18
LQ3U41	ø12	24	22	24	88	84	29	9.5	22
LQ3U51	ø19	26.5	24	32	103	98	37	16	30
LQ3U61	ø25	30	26	41	122	113.5	49	22	36

Inch Size

Model	Applicable tubing O.D.	E	E'	H	L	L'	M	Min. port size	W
LQ3U1A	1/8"	10	9	11	46.5	44.5	14	2	10
LQ3U2A	1/4"	17	16	16	57	55	20	4	14
LQ3U3A	3/8"	22.5	19.5	21	79	73	25	6.4	18
LQ3U4A	1/2"	24.5	22.5	24	88	84	29	9.5	22
LQ3U5A	3/4"	26.5	24	32	103	98	37	16	30
LQ3U6A	1"	30	26	41	122	113.5	49	22	36
LQ3U7A	1 1/4"	35	35	50	142	142	64	28.5	46
LQ3U8A	1 1/2"	39	—	60	152	—	77	36	55

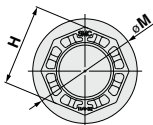

Class 7, 8

LQ3 Series

Union Reducing

How to Order

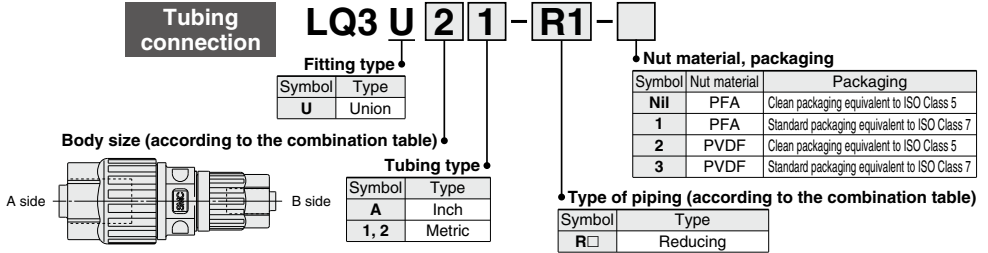

Size combination (Metric)

Size	Model	A side	B side
		Applicable tubing size (mm)	
1	LQ3U11-R1	4 x 3	3 x 2
	LQ3U21-R1	6 x 4	4 x 3
2	LQ3U21-R2		3 x 2
3	LQ3U31-R1	10 x 8	8 x 6
	LQ3U31-R2		6 x 4
	LQ3U32-R1		6 x 4
	LQ3U32-R2		4 x 3
4	LQ3U41-R1	12 x 10	10 x 8
	LQ3U41-R2		8 x 6
5	LQ3U51-R1	19 x 16	12 x 10
	LQ3U51-R2		10 x 8
6	LQ3U61-R1	25 x 22	19 x 16
	LQ3U61-R2		12 x 10

Size combination (Inch)

Size	Model	A side	B side
		Applicable tubing size (inch)	
2	LQ3U2A-R1	1/4" x 5/32"	1/8" x 0.086"
	LQ3U3A-R1	3/8" x 1/4"	1/4" x 5/32"
3	LQ3U3A-R2		1/8" x 0.086"
4	LQ3U4A-R1	1/2" x 3/8"	3/8" x 1/4"
	LQ3U4A-R2		1/4" x 5/32"
5	LQ3U5A-R1	3/4" x 5/8"	1/2" x 3/8"
	LQ3U5A-R2		3/8" x 1/4"
	LQ3U5A-R3		1/4" x 5/32"
6	LQ3U6A-R1	1" x 7/8"	3/4" x 5/8"
	LQ3U6A-R2		1/2" x 3/8"
7	LQ3U7A-R1	1 1/4" x 1.1"	1" x 7/8"

Note) For details of the applicable tubing sizes, refer to page 945.

Note) For details of the applicable tubing sizes, refer to page 945.

Dimensions

Union reducing: LQ3U-R

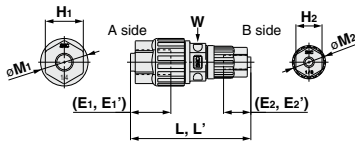

(E1, E1', E2, E2'): Reference dimension for the inserted tubing from the end surface of the nut
 (E1', E2', L'): Nut material PVDF dimensions

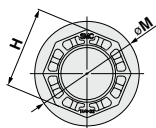

Class 7

Metric Size

Model	A side	B side	E1	E1'	E2	E2'	H1	H2	L	L'	M1	M2	Min. port size	W
	Applicable tubing O.D.													
LQ3U11-R1	ø4	ø3	10	9	10	9	11	11	46.5	44.5	14	14	2	10
LQ3U21-R1	ø6	ø4	17	16	10	9	16	11	51	48.5	20	14	2.5	14
LQ3U21-R2		ø3											2	
LQ3U31-R1	ø10	ø8	22.5	19.5	22.5	19.5	21	21	79	73	25	25	6.4	18
LQ3U31-R2		ø6											4	
LQ3U32-R1	ø8	ø6	22.5	19.5	17	16	21	16	66.5	62	25	20	4	18
LQ3U32-R2		ø4											2	
LQ3U41-R1	ø12	ø10	24	22	24.5	19.5	24	21	82.5	77	29	25	7.5	22
LQ3U41-R2		ø8											6.4	
LQ3U51-R1	ø19	ø12	26.5	24	24	22	32	24	95.5	91	37	29	9.5	30
LQ3U51-R2		ø10											7.5	
LQ3U61-R1	ø25	ø19	30	26	26.5	24	41	32	112.5	105.5	49	37	16	36
LQ3U61-R2		ø12											9.5	

Inch Size

Model	A side	B side	E1	E1'	E2	E2'	H1	H2	L	L'	M1	M2	Min. port size	W
	Applicable tubing O.D.													
LQ3U2A-R1	1/4"	1/8"	17	16	10	9	16	11	51	48.5	20	14	2	14
LQ3U3A-R1	3/8"	1/4"	22.5	19.5	17	16	21	16	66.5	62	25	20	4	18
LQ3U3A-R2		1/8"											2	
LQ3U4A-R1	1/2"	3/8"	24.5	22.5	22.5	19.5	24	21	82.5	77	29	25	6.4	22
LQ3U4A-R2		1/4"											4	
LQ3U5A-R1	3/4"	1/2"	26.5	24	24.5	22.5	32	24	95.5	91	37	29	9.5	30
LQ3U5A-R2		3/8"											7.5	
LQ3U5A-R3	1/4"	17	16	21	16	81	77	20	4	20	4	20	4	
LQ3U6A-R1	1"	3/4"	30	26	26.5	24	41	32	112.5	105.5	49	37	16	36
LQ3U6A-R2		1/2"											9.5	
LQ3U7A-R1	1 1/4"	1"	35	35	30	26	50	41	132.5	128.2	64	49	22	46

- LVC
- LVA
- LVH
- LVD
- LVQ
- LVP
- LVW
- LQ1
- LQ3
- LVN
- LQHB
- TL TIL
- TLM TILM
- TD TID
- TH TIH

Union Elbow Reducing

How to Order

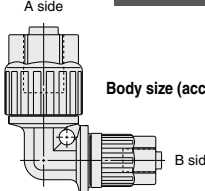

Tube connection

Body size (according to the combination table)

Fitting type

Symbol	Type
E	Union elbow

Tube type

Symbol	Type
A	Inch
1, 2	Metric

Nut material, packaging

Symbol	Nut material	Packaging
NII	PFA	Clean packaging equivalent to ISO Class 5
1	PFA	Standard packaging equivalent to ISO Class 7
2	PVDF	Clean packaging equivalent to ISO Class 5
3	PVDF	Standard packaging equivalent to ISO Class 7

Type of piping (according to the combination table)

Symbol	Type
R□	Reducing

Size combination (Metric)

Size	Model	A side	B side
		Applicable tubing size (mm)	
1	LQ3E11-R1	4 x 3	3 x 2
	LQ3E21-R1		4 x 3
2	LQ3E21-R2	6 x 4	3 x 2
	LQ3E31-R1		8 x 6
3	LQ3E31-R2	10 x 8	6 x 4
	LQ3E32-R1		6 x 4
	LQ3E32-R2	8 x 6	4 x 3
4	LQ3E41-R1	12 x 10	10 x 8
	LQ3E41-R2		8 x 6
5	LQ3E51-R1	19 x 16	12 x 10
	LQ3E51-R2		10 x 8
6	LQ3E61-R1	25 x 22	19 x 16
	LQ3E61-R2		12 x 10

Size combination (Inch)

Size	Model	A side	B side
		Applicable tubing size (inch)	
2	LQ3E2A-R1	1/4" x 5/32"	1/8" x 0.086"
	LQ3E3A-R1		1/4" x 5/32"
3	LQ3E3A-R2	3/8" x 1/4"	1/8" x 0.086"
	LQ3E4A-R1		3/8" x 1/4"
4	LQ3E4A-R2	1/2" x 3/8"	1/4" x 5/32"
	LQ3E5A-R1		1/2" x 3/8"
5	LQ3E5A-R2	3/4" x 5/8"	3/8" x 1/4"
	LQ3E5A-R3		1/4" x 5/32"
	LQ3E6A-R1		3/4" x 5/8"
6	LQ3E6A-R2	1" x 7/8"	1/2" x 3/8"

(Note) For details of the applicable tubing sizes, refer to page 945.

(Note) For details of the applicable tubing sizes, refer to page 945.

Dimensions

Union elbow reducing: LQ3E-R

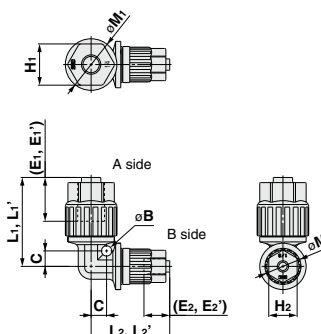

(E1, E1', E2, E2'): Reference dimension for the inserted tubing from the end surface of the nut
(E1', E2'), L1', L2': Nut material PVDF dimensions

Metric Size

Model	A side Applicable tubing O.D.	B side Applicable tubing O.D.	B	C	E1	E1'	E2	E2'	H1	H2	L1	L1'	L2	L2'	M1	M2	Mn ref size	
LQ3E11-R1	ø4	ø3	3.5	4.8	10	9	10	9	11	11	28.5	27.5	28.5	27.5	14	14	2	
LQ3E21-R1		ø4															2.5	
LQ3E21-R2	ø6	ø3	4	6	17	16	10	9	16	11	34.5	33.5	30.5	29.5	20	14	2	
LQ3E31-R1		ø8					22.5	19.5		21	21	47.5	44.5	47.5	44.5	25	25	6.4
LQ3E31-R2	ø10	ø6	5	9	22.5	19.5	17	16	21	16	47.5	44.5	38	37	20	20	4	
LQ3E32-R1		ø6																
LQ3E32-R2	ø8	ø4	5	9	22.5	19.5	10	9	21	11	47.5	44.5	33.5	32.5	25	14	2.5	
LQ3E41-R1		ø10															7.5	
LQ3E41-R2	ø12	ø8	6	10	24	22	22.5	19.5	24	21	52.5	50.5	48.5	45.5	29	25	6.4	
LQ3E51-R1		ø19															7.5	
LQ3E51-R2	ø19	ø12	7	14	26.5	24	24	22	32	21	64	61.5	58.5	56.5	37	29	9.5	
LQ3E61-R1		ø19															7.5	
LQ3E61-R2	ø25	ø12	8	18	30	26	26.5	24	41	32	78	74	70	67.5	49	37	16	
							24	22		24	74	74	64.5	62.5	29	29	9.5	

Inch Size

Model	A side Applicable tubing O.D.	B side Applicable tubing O.D.	B	C	E1	E1'	E2	E2'	H1	H2	L1	L1'	L2	L2'	M1	M2	Mn ref size	
LQ3E2A-R1	1/4"	1/8"	4	6	17	16	10	9	16	11	34.5	33.5	30.5	29.5	20	14	2	
LQ3E3A-R1		1/4"															2	
LQ3E3A-R2	3/8"	1/8"	5	9	22.5	19.5	10	9	21	11	47.5	44.5	33.5	32.5	25	14	2	
LQ3E4A-R1		3/8"					22.5	19.5		24	21	52.5	50.5	48.5	45.5	29	25	6.4
LQ3E4A-R2	1/2"	1/4"	6	10	24.5	22.5	17	16	24	21	61.5	58.5	39	38	20	20	4	
LQ3E5A-R1		1/2"															9.5	
LQ3E5A-R2	3/4"	3/8"	7	14	26.5	24	22.5	19.5	32	21	64	61.5	53.5	50.5	37	25	6.4	
LQ3E5A-R3		1/4"															4	
LQ3E6A-R1		3/4"					26.5	24	41	32	78	74	70	67.5	49	37	16	
LQ3E6A-R2	1"	1/2"	8	18	30	26	24.5	22.5	41	32	78	74	70	67.5	49	29	9.5	

Union Tee Reducing

How to Order

Ordering Code Example: LQ3 T 2 A - R1 - []

Tubing connection

Fitting type

Symbol	Type
T	Union tee

Body size (according to the combination table)

Tubing type

Symbol	Type
A	Inch
1, 2	Metric

Nut material, packaging

Symbol	Nut material	Packaging
Nil	PFA	Clean packaging equivalent to ISO Class 5
1	PFA	Standard packaging equivalent to ISO Class 7
2	PVDF	Clean packaging equivalent to ISO Class 5
3	PVDF	Standard packaging equivalent to ISO Class 7

Type of piping (according to the combination table)

Symbol	Type
R□	Reducing

Size combination (Metric)

Size	Model	A side (Left)	B side (Center)	C side (Right)
		Applicable tubing size (mm)		
1	LQ3T11-R1	4 x 3	3 x 2	4 x 3
	LQ3T11-R5		4 x 3	3 x 2
2	LQ3T21-R1	6 x 4	4 x 3	6 x 4
	LQ3T21-R2		3 x 2	6 x 4
	LQ3T21-R5		6 x 4	4 x 3
3	LQ3T21-R6	10 x 8	6 x 4	3 x 2
	LQ3T31-R1		8 x 6	10 x 8
	LQ3T31-R2		6 x 4	10 x 8
	LQ3T31-R5		10 x 8	8 x 6
	LQ3T31-R6		10 x 8	6 x 4
4	LQ3T32-R1	8 x 6	6 x 4	8 x 6
	LQ3T32-R5		8 x 6	6 x 4
	LQ3T41-R1		10 x 8	12 x 10
5	LQ3T41-R5	12 x 10	12 x 10	10 x 8
	LQ3T51-R1		12 x 10	19 x 16
6	LQ3T51-R5	19 x 16	19 x 16	12 x 10
	LQ3T61-R1		19 x 16	25 x 22
	LQ3T61-R5		25 x 22	19 x 16

Note) For details of the applicable tubing sizes, refer to page 945.

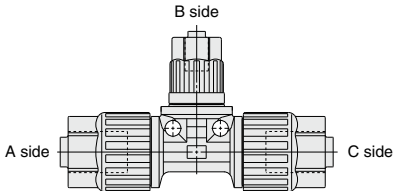

Size combination (Inch)

Size	Model	A side (Left)	B side (Center)	C side (Right)	
		Applicable tubing size (inch)			
2	LQ3T2A-R1	1/4" x 5/32"	1/8" x 0.086"	1/4" x 5/32"	
	LQ3T2A-R5		1/4" x 5/32"	1/8" x 0.086"	
3	LQ3T3A-R1	3/8" x 1/4"	1/4" x 5/32"	3/8" x 1/4"	
	LQ3T3A-R2		1/8" x 0.086"	3/8" x 1/4"	
	LQ3T3A-R5		3/8" x 1/4"	1/4" x 5/32"	
	LQ3T3A-R7		1/4" x 5/32"	1/4" x 5/32"	
	LQ3T3A-R9		3/8" x 1/4"	1/4" x 5/32"	
4	LQ3T4A-R1	1/2" x 3/8"	3/8" x 1/4"	1/2" x 3/8"	
	LQ3T4A-R2		1/4" x 5/32"	1/2" x 3/8"	
	LQ3T4A-R5		1/2" x 3/8"	3/8" x 1/4"	
	LQ3T4A-R6		1/2" x 3/8"	1/4" x 5/32"	
	LQ3T4A-R7		3/8" x 1/4"	3/8" x 1/4"	
	LQ3T4A-R8		1/4" x 5/32"	1/4" x 5/32"	
	LQ3T4A-R9		3/8" x 1/4"	3/8" x 1/4"	
	LQ3T5A-R1		3/4" x 5/8"	1/2" x 3/8"	3/4" x 5/8"
	LQ3T5A-R2			3/8" x 1/4"	3/4" x 5/8"
LQ3T5A-R3	1/4" x 5/32"	3/4" x 5/8"			
5	LQ3T5A-R5	3/4" x 5/8"	3/4" x 5/8"	1/2" x 3/8"	
	LQ3T5A-R6		3/4" x 5/8"	3/8" x 1/4"	
	LQ3T5A-R7		1/2" x 3/8"	1/2" x 3/8"	
	LQ3T5A-R9		1/2" x 3/8"	3/4" x 5/8"	
	LQ3T5A-R10		3/8" x 1/4"	3/4" x 5/8"	
	LQ3T5A-R11		1/2" x 3/8"	1/4" x 5/32"	
	LQ3T5A-R12		3/4" x 5/8"	1/4" x 5/32"	
	LQ3T6A-R1		1" x 7/8"	3/4" x 5/8"	1" x 7/8"
	LQ3T6A-R2			1/2" x 3/8"	1" x 7/8"
	LQ3T6A-R3			3/8" x 1/4"	1" x 7/8"
LQ3T6A-R4	1/4" x 5/32"	1" x 7/8"			
LQ3T6A-R5	1" x 7/8"	3/4" x 5/8"			
LQ3T6A-R6	1" x 7/8"	1/2" x 3/8"			
LQ3T6A-R7	3/4" x 5/8"	3/4" x 5/8"			
6	LQ3T6A-R9	3/4" x 5/8"	1" x 7/8"	3/4" x 5/8"	
	LQ3T6A-R10		1/2" x 3/8"	1/2" x 3/8"	
	LQ3T6A-R12		1" x 7/8"	3/8" x 1/4"	
	LQ3T6A-R13		1" x 7/8"	1/4" x 5/32"	
	LQ3T6A-R14		3/4" x 5/8"	1" x 7/8"	

Note) For details of the applicable tubing sizes, refer to page 945.

LVC
LVA
LVH
LVD
LVQ
LVP
LVW
LQ1
LQ3
LVN
LQHB
TL
TIL
TLM
TILM
TD
TID
TH
TIH

LQ3 Series

Dimensions

Union tee reducing: LQ3T-R

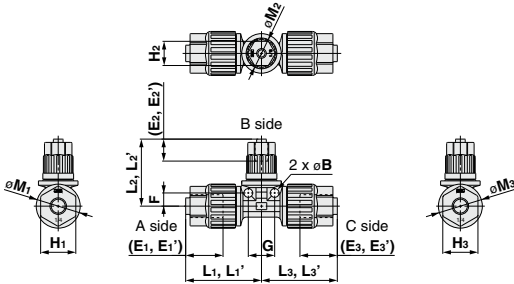

(E1, E1', E2, E2', E3, E3'): Reference dimension for the inserted tubing from the end surface of the nut

(E1, E2', E3), L1', L2', L3': Nut material PVDF dimensions

Metric Size

Model	A side (Left) Applicable tubing O.D.	B side (Center)	C side (Right) Applicable tubing O.D.	B	E1	E1'	E2	E2'	E3	E3'	F	G	H1	H2	H3	L1	L1'	L2	L2'	L3	L3'	M1	M2	M3	Min. port size	
LQ3T11-R1	ø4	ø3	ø4	3.5	10	9	10	9	10	9	4.8	9.5	11	11	11	28.5	27.5	28.5	27.5	28.5	27.5	14	14	14	2	
LQ3T11-R5		ø4	ø3																							
LQ3T21-R1		ø4	ø6																							
LQ3T21-R2	ø6	ø3	ø6	4	17	16	10	9	17	16	6	12	16	11	16	34.5	33.5	30.5	29.5	34.5	33.5	20	14	20	2.5	
LQ3T21-R5		ø6	ø4																							
LQ3T21-R6		ø6	ø3																							
LQ3T31-R1	ø10	ø8	ø10	5	22.5	19.5	17	16	22.5	19.5	9	18	21	21	21	47.5	44.5	38	37	47.5	44.5	25	20	25	20	6.4
LQ3T31-R2		ø6	ø10																							
LQ3T31-R5		ø10	ø8																							
LQ3T31-R6	ø8	ø6	ø8	5	22.5	19.5	17	16	22.5	19.5	9	18	21	21	21	47.5	44.5	38	37	47.5	44.5	25	20	25	20	6.4
LQ3T32-R1		ø6	ø8																							
LQ3T32-R5		ø8	ø6																							
LQ3T41-R1	ø12	ø10	ø12	6	24	22	24	22	24	22	10	20	24	24	24	52.5	50.5	48.5	45.5	52.5	50.5	29	25	29	25	7.5
LQ3T41-R5		ø12	ø10																							
LQ3T51-R1		ø12	ø19																							
LQ3T51-R5	ø19	ø19	ø12	7	26.5	24	24	22	26.5	24	14	28	32	32	32	64	61.5	58.5	56.5	64	61.5	37	29	37	29	9.5
LQ3T61-R1		ø19	ø25																							
LQ3T61-R5		ø25	ø19																							

Inch Size

Model	A side (Left) Applicable tubing O.D.	B side (Center)	C side (Right) Applicable tubing O.D.	B	E1	E1'	E2	E2'	E3	E3'	F	G	H1	H2	H3	L1	L1'	L2	L2'	L3	L3'	M1	M2	M3	Min. port size	
LQ3T2A-R1	1/4"	1/8"	1/4"	4	17	16	10	9	17	16	6	12	16	11	16	34.5	33.5	30.5	29.5	34.5	33.5	20	14	20	2	
LQ3T2A-R5		1/4"	1/8"																							
LQ3T3A-R1		1/4"	3/8"																							
LQ3T3A-R2	3/8"	1/8"	3/8"	5	22.5	19.5	10	9	22.5	19.5	9	18	21	21	21	47.5	44.5	33.5	32.5	47.5	44.5	25	14	25	4	
LQ3T3A-R5		3/8"	1/4"																							
LQ3T3A-R7		1/4"	1/4"																							
LQ3T3A-R9	1/4"	3/8"	1/4"	17	16	16	17	16	17	16	9	18	16	21	16	16	38	37	47.5	44.5	38	37	20	20	4	
LQ3T4A-R1		3/8"	1/2"																							
LQ3T4A-R2		1/4"	1/2"																							
LQ3T4A-R5	1/2"	1/2"	3/8"	6	24.5	22.5	24.5	22.5	22.5	19.5	10	20	24	24	21	16	52.5	50.5	48.5	45.5	52.5	50.5	29	25	29	6.4
LQ3T4A-R6		1/2"	1/4"																							
LQ3T4A-R7		3/8"	3/8"																							
LQ3T4A-R8	3/8"	1/4"	1/4"	22.5	19.5	24.5	22.5	19.5	22.5	19.5	14	28	32	21	24	48.5	45.5	52.5	50.5	48.5	45.5	25	29	25	6.4	
LQ3T4A-R9		1/2"	3/8"																							
LQ3T5A-R1		1/2"	3/4"																							
LQ3T5A-R2	3/4"	3/8"	3/4"	7	26.5	24	24.5	22.5	24.5	22.5	14	28	32	21	32	64	61.5	58.5	56.5	64	61.5	37	29	37	9.5	
LQ3T5A-R3		1/4"	3/4"																							
LQ3T5A-R5		3/4"	1/2"																							
LQ3T5A-R6	1/2"	3/4"	3/8"	24.5	22.5	19.5	26.5	24	24.5	22.5	14	28	32	21	24	58.5	56.5	64	61.5	58.5	56.5	29	29	29	9.5	
LQ3T5A-R7		1/2"	1/2"																							
LQ3T5A-R9		3/4"	1/2"																							
LQ3T5A-R10	3/8"	3/4"	3/8"	22.5	19.5	24.5	22.5	19.5	24.5	19.5	14	28	32	21	32	54.5	51.5	64	61.5	54.5	51.5	25	37	25	6.4	
LQ3T5A-R11		1/2"	1/4"																							
LQ3T5A-R12		3/4"	1/4"																							
LQ3T6A-R1	1"	3/4"	1"	30	26	26	26.5	24	26.5	24	18	36	41	16	78	74	70	67.5	64.5	62.5	78	74	49	37	16	
LQ3T6A-R2		1/2"	1"																							
LQ3T6A-R3		3/8"	1"																							
LQ3T6A-R4	1"	1/4"	1"	30	26	26	17	16	30	26	18	36	41	16	78	74	70	67.5	64.5	62.5	78	74	49	37	16	
LQ3T6A-R5		1"	3/4"																							
LQ3T6A-R6		1"	1/2"																							
LQ3T6A-R7	3/4"	3/4"	3/4"	26.5	24	24.5	22.5	19.5	26.5	24	18	36	41	32	41	78	74	70	67.5	64.5	62.5	78	74	49	37	
LQ3T6A-R9		1/2"	1"																							
LQ3T6A-R10		1/2"	1"																							
LQ3T6A-R12	1"	1"	3/8"	30	26	30	22.5	19.5	22.5	19.5	14	28	41	41	21	78	74	78	74	60	57	49	49	25	6.4	
LQ3T6A-R13		1"	1/4"																							
LQ3T6A-R14		3/4"	1"																							

How to Order

Tubing connection

LQ3 E 21 - S - □

Fitting type

Symbol	Type
E	Union elbow

Nut material, packaging

Symbol	Nut material	Packaging
Nil	PFA	Clean packaging equivalent to ISO Class 5
1	PFA	Standard packaging equivalent to ISO Class 7
2	PVDF	Clean packaging equivalent to ISO Class 5
3	PVDF	Standard packaging equivalent to ISO Class 7

Thread type

Symbol	Type
S	Space saving

Size combination

Size	No.	Applicable tubing size (mm)
2	1	6 x 4
3	1	10 x 8
3	2	8 x 6
4	1	12 x 10
5	1	19 x 16
6	1	25 x 22

Note) For details of the applicable tubing sizes, refer to page 945.

Size	Symbol	Applicable tubing size (inch)
2	A	1/4" x 5/32"
3	A	3/8" x 1/4"
4	A	1/2" x 3/8"
5	A	3/4" x 5/8"
6	A	1" x 7/8"
7	A	1 1/4" x 1.1"

Note) For details of the applicable tubing sizes, refer to page 945.

Dimensions

Space saving union elbow: LQ3E-S

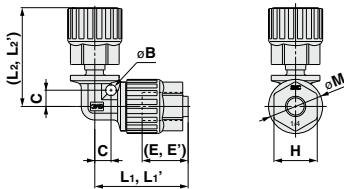

(E,E'): Reference dimension for the inserted tubing from the end surface of the nut
 (E'), L1', L2': Nut material PVDF dimensions

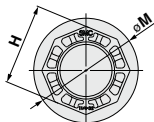

Class 7

Metric Size

Model	Applicable tubing O.D.	B	C	E	E'	H	L ₁	L ₁ '	L ₂	L ₂ '	M	Min. port size
LQ3E21-S	ø6	4	6	17	16	16	34.5	33.5	39.5	38.5	20	3.9
LQ3E31-S	ø10	5	9	22.5	19.5	21	47.5	44.5	52.5	49.5	25	7.5
LQ3E32-S	ø8								49.5	46.5		
LQ3E41-S	ø12	6	10	24	22	24	52.5	50.5	54.5	52.5	29	9.5
LQ3E51-S	ø19	7	14	26.5	24	32	64	61.5	66	63.5	37	15.8
LQ3E61-S	ø25	8	18	30	26	41	78	74	80	76	49	22

Inch Size

Model	Applicable tubing O.D.	B	C	E	E'	H	L ₁	L ₁ '	L ₂	L ₂ '	M	Min. port size
LQ3E2A-S	1/4"	4	6	17	16	16	34.5	33.5	39.5	38.5	20	3.9
LQ3E3A-S	3/8"	5	9	22.5	19.5	21	47.5	44.5	49.5	46.5	25	6.3
LQ3E4A-S	1/2"								6	10		
LQ3E5A-S	3/4"	7	14	26.5	24	32	64	61.5	66	63.5	37	15.8
LQ3E6A-S	1"	8	18	30	26	41	78	74	80	76	49	22
LQ3E7A-S	1 1/4"	9	22	35	35	50	92.5	92.5	97.5	97.5	64	28

LVC

LVA

LVH

LVD

LVQ

LVP

LVW

LQ1

LQ3

LVN

LQHB

TL

TIL

TLM

TILM

TD

TID

TH

TIH

Space Saving Branch Tee

How to Order

Tubing connection

LQ3 T 21 - S B -

Fitting type

Symbol	Type
T	Union tee

Nut material, packaging

Symbol	Nut material	Packaging
Nil	PFA	Clean packaging equivalent to ISO Class 5
1	PFA	Standard packaging equivalent to ISO Class 7
2	PVDF	Clean packaging equivalent to ISO Class 5
3	PVDF	Standard packaging equivalent to ISO Class 7

Thread type

Symbol	Type
B	Branch tee

Tubing type

Symbol	Type
S	Space saving

Size combination

Size	No.	Applicable tubing size (mm)
2	1	6 x 4
3	1	10 x 8
3	2	8 x 6
4	1	12 x 10
5	1	19 x 16
6	1	25 x 22

Size	Symbol	Applicable tubing size (inch)
2	A	1/4" x 5/32"
3	A	3/8" x 1/4"
4	A	1/2" x 3/8"
5	A	3/4" x 5/8"
6	A	1" x 7/8"

Note) For details of the applicable tubing sizes, refer to page 945.

Note) For details of the applicable tubing sizes, refer to page 945.

Dimensions

Space saving branch tee: LQ3T-SB

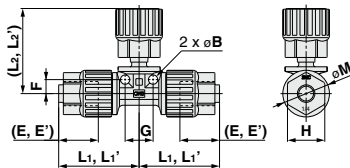

(E, E'): Reference dimension for the inserted tubing from the end surface of the nut
 (E'), L1', L2': Nut material PVDF dimensions

Metric Size

Model	Applicable tubing O.D.	B	E	E'	F	G	H	L ₁	L ₁ '	L ₂	L ₂ '	M	Min. port size
LQ3T21-SB	ø6	4	17	16	6	12	16	34.5	33.5	39.5	38.5	20	3.9
LQ3T31-SB	ø10	5	22.5	19.5	9	18	21	47.5	44.5	52.5	49.5	25	7.5
LQ3T32-SB	ø8									49.5	46.5	6.3	
LQ3T41-SB	ø12	6	24	22	10	20	24	52.5	50.5	54.5	52.5	29	9.5
LQ3T51-SB	ø19	7	26.5	24	14	28	32	64	61.5	66	63.5	37	15.8
LQ3T61-SB	ø25	8	30	26	18	36	41	78	74	80	76	49	22

Inch Size

Model	Applicable tubing O.D.	B	E	E'	F	G	H	L ₁	L ₁ '	L ₂	L ₂ '	M	Min. port size
LQ3T2A-SB	1/4"	4	17	16	6	12	16	34.5	33.5	39.5	38.5	20	3.9
LQ3T3A-SB	3/8"	5	22.5	19.5	9	18	21	47.5	44.5	49.5	46.5	25	6.3
LQ3T4A-SB	1/2"									54.5	52.5	29	9.5
LQ3T5A-SB	3/4"	7	26.5	24	14	28	32	64	61.5	66	63.5	37	15.8
LQ3T6A-SB	1"	8	30	26	18	36	41	78	74	80	76	49	22

LQ3 Series Space Saving Run Tee

How to Order

Tubing connection

LQ3 T 21 - S R -

Fitting type

Symbol	Type
T	Union tee

Nut material, packaging

Symbol	Nut material	Packaging
Nil	PFA	Clean packaging equivalent to ISO Class 5
1	PFA	Standard packaging equivalent to ISO Class 7
2	PVDF	Clean packaging equivalent to ISO Class 5
3	PVDF	Standard packaging equivalent to ISO Class 7

Thread type

Symbol	Type
R	Run tee

Tubing type

Symbol	Type
S	Space saving

Size combination

Size	No.	Applicable tubing size (mm)
2	1	6 x 4
3	1	10 x 8
3	2	8 x 6
4	1	12 x 10
5	1	19 x 16
6	1	25 x 22

Size	Symbol	Applicable tubing size (inch)
2	A	1/4" x 5/32"
3	A	3/8" x 1/4"
4	A	1/2" x 3/8"
5	A	3/4" x 5/8"
6	A	1" x 7/8"

Note) For details of the applicable tubing sizes, refer to page 945.

Note) For details of the applicable tubing sizes, refer to page 945.

Dimensions

Space saving run tee: LQ3T-SR

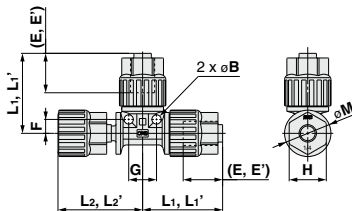

Metric Size

Model	Applicable tubing O.D.	B	E	E'	F	G	H	L ₁	L ₁ '	L ₂	L ₂ '	M	Min. port size
LQ3T21-SR	ø6	4	17	16	6	12	16	34.5	33.5	39.5	38.5	20	3.9
LQ3T31-SR	ø10	5	22.5	19.5	9	18	21	47.5	44.5	52.5	49.5	25	7.5
LQ3T32-SR	ø8	5	22.5	19.5	9	18	21	47.5	44.5	49.5	46.5	25	6.3
LQ3T41-SR	ø12	6	24	22	10	20	24	52.5	50.5	54.5	52.5	29	9.5
LQ3T51-SR	ø19	7	26.5	24	14	28	32	64	61.5	66	63.5	37	15.8
LQ3T61-SR	ø25	8	30	26	18	36	41	78	74	80	76	49	22

Inch Size

Model	Applicable tubing O.D.	B	E	E'	F	G	H	L ₁	L ₁ '	L ₂	L ₂ '	M	Min. port size
LQ3T2A-SR	1/4"	4	17	16	6	12	16	34.5	33.5	39.5	38.5	20	3.9
LQ3T3A-SR	3/8"	5	22.5	19.5	9	18	21	47.5	44.5	49.5	46.5	25	6.3
LQ3T4A-SR	1/2"	6	24.5	22.5	10	20	24	52.5	50.5	54.5	52.5	29	9.5
LQ3T5A-SR	3/4"	7	26.5	24	14	28	32	64	61.5	66	63.5	37	15.8
LQ3T6A-SR	1"	8	30	26	18	36	41	78	74	80	76	49	22

(E, E'): Reference dimension for the inserted tubing from the end surface of the nut

(E), L₁', L₂': Nut material PVDF dimensions

LQ3 Series Tubing Extension Straight Connector

How to Order

Tubing connection

LQ3 H 2A - T -

Fitting type

Symbol	Type
H	Connector

Nut material, packaging

Symbol	Nut material	Packaging
Nil	PFA	Clean packaging equivalent to ISO Class 5
1	PFA	Standard packaging equivalent to ISO Class 7
2	PVDF	Clean packaging equivalent to ISO Class 5
3	PVDF	Standard packaging equivalent to ISO Class 7

Thread type

Symbol	Type
T	Tubing extension

Size combination

Size	No.	Applicable tubing size (mm)
2	1	6 x 4
3	1	10 x 8
3	2	8 x 6
4	1	12 x 10
5	1	19 x 16
6	1	25 x 22

Note) For details of the applicable tubing sizes, refer to page 945.

Size	Symbol	Applicable tubing size (inch)
2	A	1/4" x 5/32"
3	A	3/8" x 1/4"
4	A	1/2" x 3/8"
5	A	3/4" x 5/8"
6	A	1" x 7/8"
7	A	1 1/4" x 1.1"

Note) For details of the applicable tubing sizes, refer to page 945.

Dimensions

Tubing extension straight connector: LQ3H-T

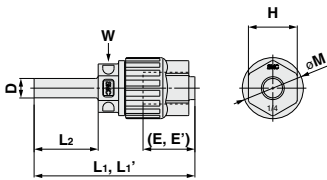

(E, E'): Reference dimension for the inserted tubing from the end surface of the nut
(E), L': Nut material PVDF dimensions
W: Width across flats dimension

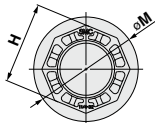

Class 7

Metric Size

Model	Applicable tubing O.D.	D	E	E'	H	L ₁	L ₁ '	L ₂	M	Min. port size	W
LQ3H21-T	ø6	ø6	17	16	16	53	51.5	18	20	3.9	14
LQ3H31-T	ø10	ø10	22.5	19.5	21	67.5	64.5	22.5	25	7.5	18
LQ3H32-T	ø8	ø8									
LQ3H41-T	ø12	ø12	24	22	24	74	72	24	29	9.5	22
LQ3H51-T	ø19	ø19	26.5	24	32	83.5	81	26.5	37	15.8	30
LQ3H61-T	ø25	ø25	30	26	41	97.5	93.5	31	49	22	36

Inch Size

Model	Applicable tubing O.D.	D	E	E'	H	L ₁	L ₁ '	L ₂	M	Min. port size	W
LQ3H2A-T	1/4"	1/4"	17	16	16	53	51.5	18	20	3.9	14
LQ3H3A-T	3/8"	3/8"	22.5	19.5	21	65.5	62.5	23.5	25	6.3	18
LQ3H4A-T	1/2"	1/2"									
LQ3H5A-T	3/4"	3/4"	26.5	24	32	83.5	81	26.5	37	15.8	30
LQ3H6A-T	1"	1"	30	26	41	97.5	93.5	31	49	22	36
LQ3H7A-T	1 1/4"	1 1/4"	35	35	50	120.5	120.5	41.5	64	28	46

LQ3 Series Straight Adapter

How to Order

Tubing connection

LQ3 A 21 - □

Fitting type

Symbol	Type
A	Straight adapter

Nut material, packaging

Symbol	Nut material	Packaging
Nil	PFA	Clean packaging equivalent to ISO Class 5
1	PFA	Standard packaging equivalent to ISO Class 7
2	PVDF	Clean packaging equivalent to ISO Class 5
3	PVDF	Standard packaging equivalent to ISO Class 7

Size combination

Size	No.	Applicable tubing size (mm)	Applicable piping size
2	1	6 x 4	ø13.7 x ø9
2	2		ø21.3 x ø15.4
2	3		ø26.7 x ø20.5
2	4		ø33.4 x ø26.3
2	5		ø60.3 x ø52.5
3	2	8 x 6	ø13.7 x ø9
3	4		ø21.3 x ø15.4
3	6		ø26.7 x ø20.5
3	7	10 x 8	ø33.4 x ø26.3
3	8	8 x 6	
4	1	12 x 10	ø21.3 x ø15.4
4	2		ø26.7 x ø20.5
4	3		ø33.4 x ø26.3
4	4		ø60.3 x ø52.5
5	1	19 x 16	ø21.3 x ø15.4
5	2		ø26.7 x ø20.5
5	3		ø33.4 x ø26.3
6	1	25 x 22	ø26.7 x ø20.5
6	2		ø33.4 x ø26.3
6	3		ø60.3 x ø52.5

Note) For details of the applicable tubing sizes, refer to page 945.

Size	Symbol	Applicable tubing size (inch)	Applicable piping size
2	A	1/4" x 5/32"	ø13.7 x ø9
2	B		ø21.3 x ø15.4
2	C		ø26.7 x ø20.5
2	D		ø33.4 x ø26.3
2	E		ø60.3 x ø52.5
3	A	3/8" x 1/4"	ø13.7 x ø9
3	B		ø21.3 x ø15.4
3	C		ø26.7 x ø20.5
4	A	1/2" x 3/8"	ø21.3 x ø15.4
4	B		ø26.7 x ø20.5
4	C		ø33.4 x ø26.3
5	A	3/4" x 5/8"	ø60.3 x ø52.5
5	B		ø21.3 x ø15.4
5	C	1" x 3/4"	ø26.7 x ø20.5
6	A		ø33.4 x ø26.3
6	B		ø60.3 x ø52.5
7	A	1 1/4" x 1.1"	ø33.4 x ø26.3

Note) For details of the applicable tubing sizes, refer to page 945.

LVC

LVA

LVH

LVD

LVQ

LVP

LVW

LQ1

LQ3

LVN

LQHB

TL

TIL

TLM

TILM

TD

TID

TH

TIH

LQ3 Series

Dimensions

Straight Adapter: LQ3A

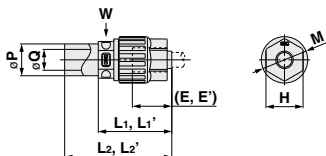

(E,E'): Reference dimension for the inserted

tubing from the end surface of the nut

(E),L1',L2': Nut material PVDF dimensions

W: Width across flats dimension

Metric Size

Model	E	E'	H	L ₁	L ₁ '	L ₂	L ₂ '	M	Min. port size	P	Q	W
LQ3A21	17	16	16	32	30.5	46	44.5	20	4	13.7	9	14
LQ3A22						58	56.5			21.3	15.4	
LQ3A23				32.5	31	70.5	69			26.7	20.5	
LQ3A24						74.5	73			33.4	26.3	
LQ3A25						60.3	52.5					
LQ3A32	22.5	19.5	21	40	39	54	53	25	6.4	13.7	9	18
LQ3A34						66	65			21.3	15.4	
LQ3A36				66	26.7	20.5						
LQ3A37				44	41	82	79			7.5	33.4	
LQ3A41	24	22	24	47	45	80	78	29	9.5	21.3	15.4	22
LQ3A42										26.7	20.5	
LQ3A43				33.4	26.3							
LQ3A44				49	47	88	86			60.3	52.5	
LQ3A51	26.5	24	32	57	54.5	95	92.5	37	15.4	21.3	15.4	30
LQ3A52									16	26.7	20.5	
LQ3A53									33.4	26.3		
LQ3A61									20.5	26.7	20.5	
LQ3A62	30	26	41	66.5	62.5	104.5	100.5	49	22	33.4	26.3	36
LQ3A63				68.5	64.5	107.5	103.5			60.3	52.5	

Inch Size

Model	E	E'	H	L ₁	L ₁ '	L ₂	L ₂ '	M	Min. port size	P	Q	W
LQ3A2A	17	16	16	32	30.5	46	44.5	20	4	13.7	9	14
LQ3A2B						58	56.5			21.3	15.4	
LQ3A2C				32.5	31	70.5	69			26.7	20.5	
LQ3A2D						74.5	73			33.4	26.3	
LQ3A2E						60.3	52.5					
LQ3A3A	22.5	19.5	21	40	39	56	53	25	6.4	13.7	9	18
LQ3A3B						66	65			21.3	15.4	
LQ3A3C				66	65	26.7	20.5					
LQ3A4A				49	47	88	86			60.3	52.5	
LQ3A4B	24.5	22.5	24	47	45	80	78	29	9.5	21.3	15.4	22
LQ3A4C										26.7	20.5	
LQ3A4D				33.4	26.3							
LQ3A5A	26.5	24	32	57	54.5	95	92.5	37	15.4	21.3	15.4	30
LQ3A5B									16	26.7	20.5	
LQ3A5C									33.4	26.3		
LQ3A6A	30	26	41	66.5	62.5	104.5	100.5	49	20.5	26.7	20.5	36
LQ3A6B				68.5	64.5	107.5	103.5		22	33.4	26.3	
LQ3A6C										60.3	52.5	
LQ3A7A				35	35	50	79		79	117	117	

LQ3 Series Union Flange

How to Order

Tubing connection

LQ3 F 22 - []

Fitting type

Symbol	Type
F	Union flange

Nut material, packaging

Symbol	Nut material	Packaging
NII	PFA	Clean packaging equivalent to ISO Class 5
1	PFA	Standard packaging equivalent to ISO Class 7
2	PVDF	Clean packaging equivalent to ISO Class 5
3	PVDF	Standard packaging equivalent to ISO Class 7

Size combination

Size	No.	Applicable tubing size (mm)	Applicable flange size
2	2	6 x 4	10K-20A
4	2	12 x 10	10K-20A
4	3		10K-25A
5	1	19 x 16	10K-15A
5	2		10K-20A
5	3		10K-25A
6	2	25 x 22	10K-20A
6	3		10K-25A
6	4		10K-40A

Size	Symbol	Applicable tubing size (inch)	Applicable flange size
2	B	1/4" x 5/32"	10K-20A
4	B	1/2" x 3/8"	10K-20A
4	C		10K-25A
5	A	3/4" x 5/8"	10K-15A
5	B		10K-20A
5	C		10K-25A
6	B	1" x 7/8"	10K-20A
6	C		10K-25A
6	B		10K-40A
6	D		10K-40A

Note) For details of the applicable tubing sizes, refer to page 945.

Note) For details of the applicable tubing sizes, refer to page 945.

Dimensions

Union Flange: LQ3F

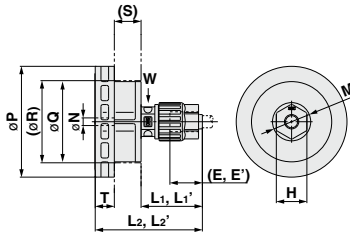

- (E, E'): Reference dimension for the inserted tubing from the end surface of the nut
 (E'), L1', L2': Nut material PVDF dimensions
 W: Width across flats dimension
 (R): I.D. of JIS flange necessary to mount this product. (Additional modification is needed.)
 JIS flange is not included in the product.

Metric Size

Model	E	E'	H	L1	L1'	L2	L2'	M	P	Q	R	S	T	W	N	Min. port size	
LQ3F22	17	16	16	32.1	30.9	56.1	54.9	20	58	42	43	14	10	14	4	4	
LQ3F42	24	22	24	49	46.8	73	70.8	29	58	42	43	14	10	22	9.5	9.5	
LQ3F43									69								
LQ3F51	26.5	24	32	58	55.3	80	77.3	37	53	58	42	43	12	10	30	16	16
LQ3F52									82								
LQ3F53									79.3								
LQ3F62	30	26	41	68.5	64.2	92.5	88.2	49	58	47	48	16	10	36	22	22	
LQ3F63									69								
LQ3F64									84								
						94.5	90.2		84								

Inch Size

Model	E	E'	H	L1	L1'	L2	L2'	M	P	Q	R	S	T	W	N	Min. port size	
LQ3F2B	17	16	16	32.1	30.9	56.1	54.9	20	58	42	43	14	10	14	4	4	
LQ3F4B	24.5	22.5	24	49	46.8	73	70.8	29	58	42	43	14	10	22	9.5	9.5	
LQ3F4C									69								
LQ3F5A	26.5	24	32	58	55.3	80	77.3	37	53	58	42	43	12	10	30	16	16
LQ3F5B									82								
LQ3F5C									79.3								
LQ3F6B	30	26	41	68.5	64.2	92.5	88.2	49	58	47	48	16	10	36	22	22	
LQ3F6C									69								
LQ3F6D									84								
						94.5	90.2		84								





LVC
LVA
LVH
LVD
LVQ
LVP
LVW
LQ1
LQ3
LVN
LQHB
TL
TIL
TLM
TILM
TD
TID
TH
TIH

How to Order Space Saving Type Fittings

This product, for use with products with one nut attached (insert bushing) has one nut removed.

LQ3 E 6A - SN -

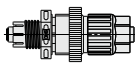
Fitting type

E	T
Union Elbow 	Union Tee 
P	U
Panel Mount Union 	Union 

Packaging

Symbol	Packaging
NH	Clean packaging equivalent to ISO Class 5
1	Standard packaging equivalent to ISO Class 7

Without a nut (including insert bushing) in one part

Applicable tubing size

Symbol	Applicable tubing size (mm)	
Size	No.	
2	1	6 x 4
3	1	10 x 8
3	2	8 x 6
4	1	12 x 10
5	1	19 x 16
6	1	25 x 22

Symbol	Applicable tubing size (inch)	
Size	No.	
2	A	1/4" x 5/32"
3	A	3/8" x 1/4"
4	A	1/2" x 3/8"
5	A	3/4" x 5/8"
6	A	1" x 7/8"

Note 1) Please choose the same size fitting as the fitting of the connecting product.

Note 2) For details of applicable tubing sizes, refer to page 945.

Connection example

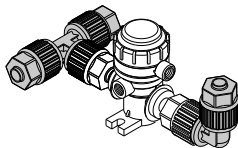

Options

Blanking plug

LQ3-1 P 03-1 - []

Size

Symbol	Size
1	1
2	2
3	3
4	4
5	5
6	6
7	7

Fitting type

Symbol	Type
P	Plug

Thread type

Symbol	Type
1	Male

Packaging

Symbol	Packaging
Nil	Clean packaging equivalent to ISO Class 5
1	Standard packaging equivalent to ISO Class 7



Used to block fittings which are not being used.

Applicable tubing size

Metric Size

Symbol	Applicable tubing size	Size
03	ø3 x ø2	1
04	ø4 x ø3	1
06	ø6 x ø4	2
08	ø8 x ø6	3
10	ø10 x ø8	3
12	ø12 x ø10	4
19	ø19 x ø16	5
25	ø25 x ø22	6

Inch Size

Symbol	Applicable tubing size	Size
03	1/8" x 0.086"	1
07	1/4" x 5/32"	2
11	3/8" x 1/4"	3
13	1/2" x 3/8"	4
19	3/4" x 5/8"	5
25	1" x 7/8"	6
32	1 1/4" x 1.1"	7

Note) For details of the applicable tubing sizes, refer to page 945.

Tubing plug

LQ3-1 P 03-2 - []

Size

Symbol	Size
1	1
2	2
3	3
4	4
5	5
6	6

Fitting type

Symbol	Type
P	Plug

Type of piping

Symbol	Type
2	Tubing

Nut material, packaging

Symbol	Nut material	Packaging
Nil	PFA	Clean packaging equivalent to ISO Class 5
1	PFA	Standard packaging equivalent to ISO Class 7
2	PVDF	Clean packaging equivalent to ISO Class 5
3	PVDF	Standard packaging equivalent to ISO Class 7

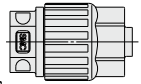

Used to block tubing which are not being used.

Applicable tubing size

Metric Size

Symbol	Applicable tubing size	Size
03	ø3 x ø2	1
04	ø4 x ø3	1
06	ø6 x ø4	2
08	ø8 x ø6	3
10	ø10 x ø8	3
12	ø12 x ø10	4
19	ø19 x ø16	5
25	ø25 x ø22	6

Inch Size

Symbol	Applicable tubing size	Size
03	1/8" x 0.086"	1
07	1/4" x 5/32"	2
11	3/8" x 1/4"	3
13	1/2" x 3/8"	4
19	3/4" x 5/8"	5
25	1" x 7/8"	6

Note) For details of the applicable tubing sizes, refer to page 945.

Nut

LQ3-1 N 03 - [] - []

Size

Symbol	Size
1	1
2	2
3	3
4	4
5	5
6	6
7	7

Fitting type

Symbol	Type
N	Nut

Nut material, packaging

Symbol	Nut material	Packaging
Nil	PFA	Clean packaging equivalent to ISO Class 5
1	PFA	Standard packaging equivalent to ISO Class 7
2	PVDF	Clean packaging equivalent to ISO Class 5
3	PVDF	Standard packaging equivalent to ISO Class 7

Quantity

Symbol	Quantity per package	Applicable size	1 to 4	5, 6	7
Nil	1 pc.	○	○	○	○
10	10 pcs.	○	○	○	○
50	50 pcs.	○	○	○	○
100	100 pcs.	○	○	○	○

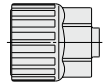

Note 1) For symbols "10," "50," and "100," the respective number of nuts are packaged as a set. For symbol "Nil," it is packaged individually. Pay attention to the quantity ordered.

Note 2) Ex.) When ordering 3 sets using the part number "LQ3-1N03-50" (50 pcs.), 150 pcs. will be ordered.

Applicable tubing size

Metric Size

Symbol	Applicable tubing size	Size
03	ø3 x ø2	1
04	ø4 x ø3	1
06	ø6 x ø4	2
08	ø8 x ø6	3
10	ø10 x ø8	3
12	ø12 x ø10	4
19	ø19 x ø16	5
25	ø25 x ø22	6

Inch Size

Symbol	Applicable tubing size	Size
03	1/8" x 0.086"	1
07	1/4" x 5/32"	2
11	3/8" x 1/4"	3
13	1/2" x 3/8"	4
19	3/4" x 5/8"	5
25	1" x 7/8"	6
32	1 1/4" x 1.1"	7

Note) For details of the applicable tubing sizes, refer to page 945.

- LVC
- LVA
- LVH
- LVD
- LVQ
- LVP
- LVW
- LQ1
- LQ3**
- LVN
- LQHB
- TL TIL
- TLM TILM
- TD TID
- TH TIH

High Purity Fluoropolymer Needle Valve

LVN Series



How to Order

LVN **2** 0 - S **07**

Body class

Symbol	Body class	Orifice dia.
2	2	ø4.4
3	3	ø8
4	4	ø10

Port B (OUT) different dia. size

Symbol	Application
Nil	Port A & B same size
Refer to the applicable tubing table to the left.	Different diameter tubing can be selected within the same body class.

LQ2 fittings

A port (IN) Applicable tubing size

Symbol	Connecting tubing O.D.	Body class		
		2	3	4
Metric sizes				
04	4 x 3	●		
06	6 x 4	○	●	
08	8 x 6		●	
10	10 x 8		○	●
12	12 x 10			○
Inch sizes				
03	1/8" x 0.086"	●		
05	3/16" x 1/8"	●		
07	1/4" x 5/32"	○	●	
11	3/8" x 1/4"		○	●
13	1/2" x 3/8"			○

○ Basic size ● With reducer

Note 1) Applicable fittings: LQ2

Note 2) For details of the applicable tubing sizes, refer to page 945.



Different diameter tubing order example

Different diameter tubing (with plug-in reducer) can be selected within the same body class.

(Example) Body class 3

A side: ø10 x ø8

B side: ø8 x ø6

Order as shown below.

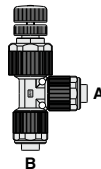

LVN30-S **10** **08**

- Different dia. tubing size (B side)
- Applicable tubing size (A side)

Standard Specifications



Specific Product Precautions

Be sure to read this before handling the products. Refer to back page 50 for Safety Instructions.

Piping

Caution

1. Connect tubing with special tools.

Refer to the pamphlet "High-Purity Fluoropolymer Fittings Hyper Fitting/LQ1, 2 Series Work Procedure Instructions" (M-E05-1) for connecting tubing and special tools. (Downloadable from our web site.)

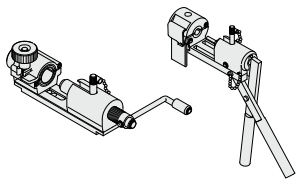

2. Tighten the nut until it touches the end surface of the body, and then tighten it an additional 1/8 turn. If the nut won't turn any further, then it means a sufficient tightening has occurred. Refer to the proper tightening torques shown below.

Tightening torque for piping

Body class	Torque (N·m)
2	1.5 to 2.0
3	3.0 to 3.5
4	7.5 to 9.0

Model	LVN20	LVN30	LVN40	
Tubing O.D. (Note)	Metric size	4, 6	6, 8, 10	10, 12
	Inch size	1/8", 3/16", 1/4"	1/4", 3/8"	3/8", 1/2"
Orifice diameter	ø4.4	ø8	ø10	
Flow rate characteristics	Kv	0.4	1.2	1.8
	Cv	0.5	1.4	2.2
Withstand pressure (MPa)	1			
Operating pressure (MPa)	0 to 0.5			
Fluid temperature (°C)	5 to 90			
Ambient temperature (°C)	0 to 60			
Weight (kg)	0.055	0.115	0.185	

Note) For details of the applicable tubing sizes, refer to page 945.

Different Diameter Tubing Applicable with Reducer

Different diameter tubing can be selected (within a body class) by using a nut and insert bushing (reducer). Applicable fitting: LQ2

Body class	Tubing O.D.									
	Metric sizes					Inch sizes				
	4	6	8	10	12	1/8"	3/16"	1/4"	3/8"	1/2"
2	●	○				●	●	○		
3		●	●	○				●	○	
4				●	○				●	○

Note) Refer to page 910 for information on changing tubing sizes. ○ Basic size ● With reducer

Flow Rate Characteristics (Fluid: Water)

LVN20

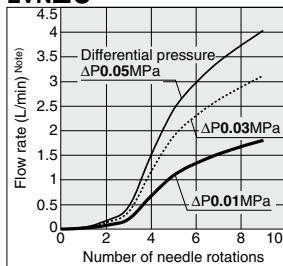

LVN30

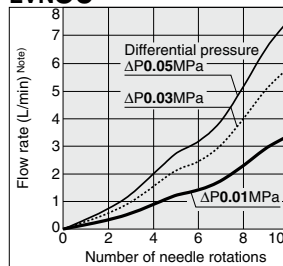

LVN40

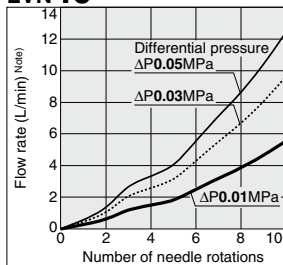

Note) As the LVN series cannot be used as a stop valve, it is not possible to set the flow rate to 0 when the number of needle rotations is set to 0. For further details, refer to the "Operating Precautions."

- LVC
- LVA
- LVH
- LVJ
- LVK
- LVP
- LVW
- LQ1
- LQ3
- LVN
- LQHB
- TL
- TIL
- TLM
- TILM
- TD
- TID
- TH
- TIH

LVN Series

Construction

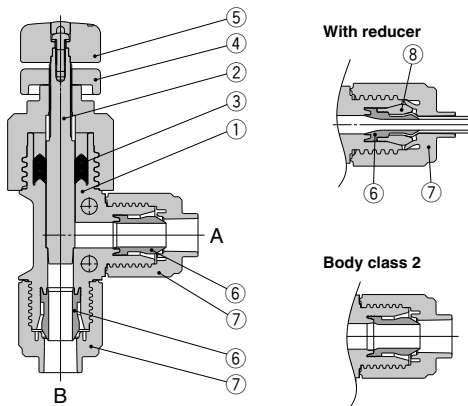

Part lists

No.	Description	Material
1	Body	PFA
2	Needle	PCTFE
3	V seal	PTFE
4	Lock nut	PVDF
5	Adjustment handle	PVDF
6	Insert bushing	PFA
7	Nut	PFA
8	Collar	PFA

Dimensions

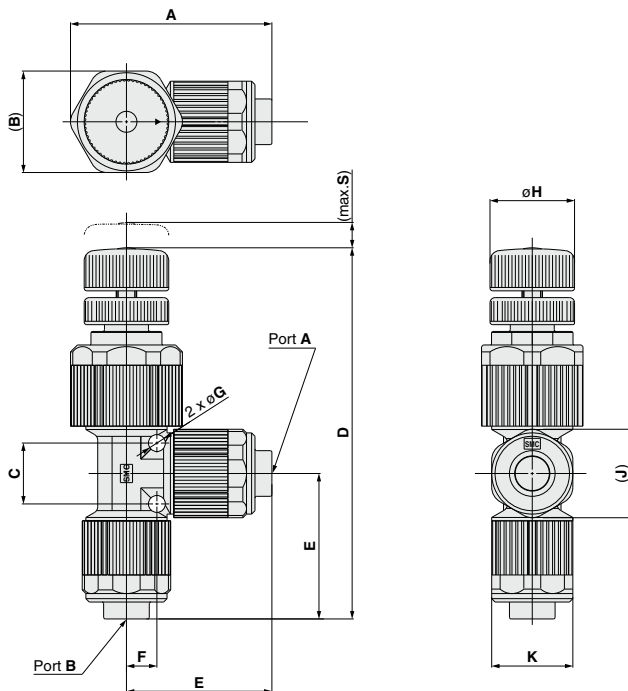

Model	A	B	C	D	E	F	G	H	J	K	S
LVN20	48	24	12	88	34.5	6	4	14	20	18	2.4
LVN30	60	30	18	110	43	9	5	25	26	24	7.5
LVN40	72	36	22	124	52	11	6	25	33	30	8

Fluoropolymer Bore Through Connector

LQHB Series

RoHS

How to Order

Tubing connection

LQHB 07 - [] - []

Symbol	Type
HB	Bore through connector

Fitting type

Nut material, packaging

Symbol	Nut material	Packaging
Nil	PFA	Clean packaging equivalent to ISO Class 5
1	PFA	Standard packaging equivalent to ISO Class 7

Thread type

Symbol	Type
Nil	R
N	NPT

Size combination

Symbol	Size	Applicable tubing size (mm)	Tubing O.D.
03	1	3 x 2	1/8"
04		4 x 3	
06	2	6 x 4	1/4"
08	3	8 x 6	3/8"
10		10 x 8	
12	4	12 x 10	1/2"
19	5	19 x 16	3/4"
25	6	25 x 22	1"

Symbol	Size	Applicable tubing size (inch)	Tubing O.D.
03	1	1/8" x 0.086"	1/8"
07	2	1/4" x 5/32"	1/4"
11	3	3/8" x 1/4"	3/8"
13	4	1/2" x 3/8"	1/2"
19	5	3/4" x 5/8"	3/4"
25	6	1" x 7/8"	1"

Note) For details of the applicable tubing sizes, refer to page 945.

Specifications

Maximum operating pressure (at 20°C)	1.0 MPa (Refer to Note 1)
Operating temperature	0 to 200°C (Refer to Note 1)
Applicable tube diameter	Please refer to the Combination Chart.

Precautions

- The operating pressure or operating temperature range for each tubing size differs depending on the usage conditions. Keep the supplied fluid pressure and temperature within the range of each specification.
- The piping should be arranged in such a way that no extraction force other than the fluid pressure should be added to the tubing.
- Avoid using in instances where the nut is soaked in the fluid.
- Screw in the R or NPT screw after inserting the tubing. (If the screw is screwed in first, the tubing may be hard to insert.)

Piping

Caution

- As with the nut tightening, refer to the tightening torques below as a guide.

Tightening torque for piping

Body size	Torque (N·m)
1	0.7 to 0.9
2	1.6 to 1.8
3	3.2 to 3.5
4	5.0 to 5.3
5	10.0 to 10.5
6	22.5 to 23.0

- Tightening
After tightening the nut by hand, use the nut tightening wrench dedicated to the LQ1 to tighten the nut securely. The tightening is enough when the clearance between the end face of the nut and the body is 2 mm or less (Refer to figure 1).

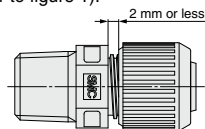

Fig. 1

LVC

LVA

LVB

LVD

LVQ

LVP

LVV

LQ1

LQ3

LVN

LQHB

TL

TIL

TLM

TILM

TD

TID

TH

TIH

LQHB Series

Dimensions

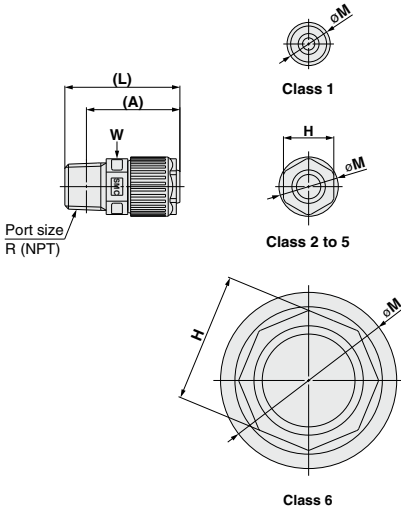

Metric Size

Model	Size	A	H	L	M	W
LQHB03-□	1	22.5	—	27	11.5	10
LQHB04-□						
LQHB06-□	2	27.5	14	34	16.5	14
LQHB08-□						
LQHB10-□	3	34.5	17	42.1	23	19
LQHB12-□						
LQHB19-□	4	40	21	49	28	23
LQHB25-□	5	50	26	61.1	39	32
LQHB25-□	6	66	36	77	49	46

Inch Size

Model	Size	A	H	L	M	W
LQHB03-□	1	22.5	—	27	11.5	10
LQHB07-□	2	27.5	14	34	16.5	14
LQHB11-□	3	34.5	17	42.1	23	19
LQHB13-□	4	40	21	49	28	23
LQHB19-□	5	50	26	61.1	39	32
LQHB25-□	6	66	36	77	49	46

Types of Use

There are presumably two different types of use for the bore through connector as indicated in conditions A and B, and the specifications will differ according to the type of use.

- Condition A**
- For applications including boring through panels or walls, etc.
 - Atmospheric release.

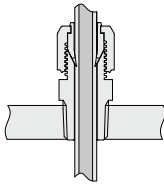

- Condition B**
- For applying sustained pressure to the female thread.
 - Using the same pressure and temperature as that of the inside of the tube.

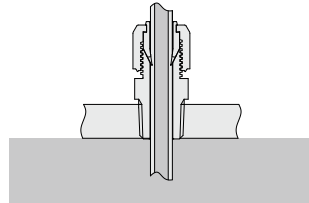

Operating range for the bore through connector

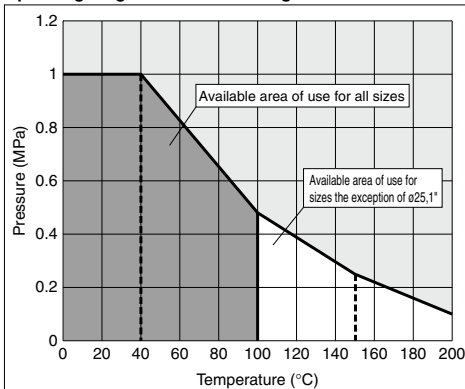

Operating range of use for the bore through connector

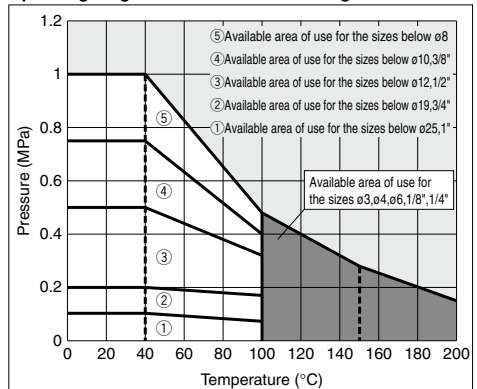



LQ1/LQ3/LVN/LQHB Series Applicable Fluids

Material and fluid compatibility check list for high purity fluoropolymer fittings

Chemical		Compatibility
Acetic acid	100%	○
Acetone	100%	○ Note 1,2)
Ammonium fluoride	40%	○
Ammonium hydroxide	30%	○
Butyl acetate	100%	○
Methylene chloride	100%	○
Hydrochloric acid	38%	○
Hydrofluoric acid	50%	○
Hydrogen peroxide	60%	○
Methanol	100%	○
Methyl ethyl Ketone	—	○ Note 2)
Nitric acid	70%	○ Note 2)
Phosphoric acid	86%	○
Caustic potash	85%	○
Sulfuric acid	100%	○ Note 2)
Toluene	—	○ Note 1,2)
Xylene	—	○ Note 2)
Sodium hydroxide (caustic soda)	100%	○ Note 2)
1.1.1-Trichloroethane	100%	○ Note 2)
Rhosphorus pentachloride	—	○
Isobutyl alcohol	—	○ Note 1)
Isopropyl alcohol	—	○ Note 1)
Ozone	—	○
Ethyl acetate	—	○ Note 1,2)
DI water (Pure water)	—	○
Nitrogen	—	○
Ultrapure water	—	○
Tmah	—	○ Note 2)

Table symbol ○ : can be used.

The material and fluid compatibility check list provides reference values as a guide only.

Note 1) Since static electricity may be generated, implement suitable countermeasures.

Note 2) In the case of nut with PVDF material, it cannot be used due to atmosphere or temperature. Use the nut with PFA material.

- Fluid temperature indicates compatibility below 200°C (below 150°C in the case of a nut with PVDF material).
- The material and fluid compatibility check list provides reference values as a guide only, therefore we do not guarantee the application to our product.
- The data above is based on the information presented by the material manufacturers.
- SMC is not responsible for its accuracy and any damage happened because of this data.

LVC
LVA
L VH
LVD
LVQ
LVP
L VW
LQ1
LQ3
LVN
LQHB
TL
TIL
TLM
TILM
TD
TID
TH
TIH



LQ1/LQ3/LVN/LQHB Series Fluoropolymer Fittings/Needle Valve/ Bore Through Connector/ Precautions 1

Be sure to read this before handling the products.
Refer to back page 50 for Safety Instructions.

Design and Selection

⚠ Warning

1. Confirm the specifications.

Give careful consideration to operating conditions such as the application, fluid and environment, and use within the operating ranges specified in this catalog.

2. Fluid

Operate within the indicated fluid temperature range.

3. Maintenance space

Ensure the necessary space for maintenance and inspections.

4. Fluid pressure range

Keep the supplied fluid pressure within the operating pressure range shown in the catalog.

5. Countermeasures for static electricity

Since static electricity may be generated depending on the fluid being used, implement suitable countermeasures.

Mounting

⚠ Warning

1. After mounting, perform suitable function and leak tests to confirm that the mounting is correct.

Piping

⚠ Caution

1. Connect tubing with special tools.

Refer to the pamphlet "High-Purity Fluoropolymer Fittings Hyper Fitting/LQ1, 2 Series Work Procedure Instructions" (M-E05-1) for connecting tubing and special tools. (Downloadable from our web site.)

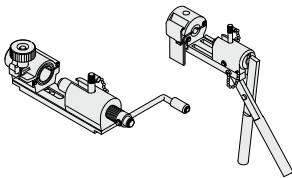

Piping

⚠ Caution

2. Tighten the nut until it touches the end surface of the body, and then tighten it an additional 1/8 turn. If the nut won't turn any further, then it means a sufficient tightening has occurred. Refer to the proper tightening torques shown below.

Nut tightening torque for piping

Body class	Torque (N·m)		
	LQ1	LQ3	LVN
1	— Note 1)	0.7 to 0.9	—
2	0.3 to 0.4	1.6 to 1.8	1.5 to 2.0
3	0.8 to 1.0	3.2 to 3.5	3.0 to 3.5
4	1.0 to 1.2	5.0 to 5.3	7.5 to 9.0
5	2.5 to 3.0	10.0 to 10.5	—
6	5.5 to 6.0	22.5 to 23.0	—
7	—	23.0 to 26.5	—

Note 1) The LQ1 Body class 1 must be tightened manually.

Note 2) Refer to page 941 for the LQHB series.

3. Use sealant tape for the piping of taper thread parts such as LQ□H and LQ□L.

Tape the ridges tightly with the sealant tape, starting one ridge width left from thread end side. 3 to 4 sealant tapes are required.

Taper thread mounting torque

Bore size	Torque (N·m)
1/8	0.6 to 0.9
1/4	0.8 to 1.2
3/8	1.0 to 1.6
1/2	1.5 to 2.0
3/4	2.0 to 2.7
1	2.5 to 3.6
1 1/4	5.5 to 7.5

4. Nut tightening torque for the panel mount union.

Nut tightening torque for the panel mount union

Body class	Torque (N·m)
1	0.5 to 0.6
2	0.6 to 0.7
3	1.2 to 1.3
4	4.5 to 4.6
5	6.8 to 6.9
6	12.4 to 12.5



LQ1/LQ3/LVN/LQHB Series Fluoropolymer Fittings/Needle Valve/ Bore Through Connector/ Precautions 2

Be sure to read this before handling the products.
Refer to back page 50 for Safety Instructions.

Operating Environment

Warning

1. Do not use in locations having an explosive atmosphere.
2. Do not operate in locations where vibration or impact occurs.
3. In locations near heat sources, block off radiated heat.

Maintenance

Warning

1. When removing or reinstalling fittings, remove any remaining chemicals and carefully replace them with DI water (pure water) or air, etc., before beginning work activities.
2. Tightening of taper threads for piping
Because the taper threads are made of resin, minute leakage may gradually occur due to stress relaxation. Perform periodic inspections, and if leakage is detected correct the problem by additional tightening. If additional tightening becomes ineffective, replace the fitting with a new product.
3. Check the following during regular maintenance, and replace components as necessary.
 - a) Scratches, gouges, abrasion, corrosion
 - b) Twisting, flattening or distortion of tubing
 - c) Hardening, deterioration or softening of tubing
4. Do not repair or patch the replaced tubing or fittings for reuse.

Operating Precautions

Warning

1. Operate within the range of the maximum operating pressure.

Caution

1. After a long period of non-use, perform inspections before beginning operation.
2. Use sufficient care in the handling of the LQ series clean packaging types when their packaging is opened.
3. The LVN series cannot be used as a stop valve. Be careful not to apply any excessive force to the stroke end, which fully opens and closes, to avoid accidental damage or changes in flow rate characteristics.

Installation of Tubing

Caution

1. Cut the end of the tubing at a right angle and pass it through the fitting nut. After placing the tubing in the holder, push it onto the insert bushing until it stops and clamp it with the knob.
As a guide when tightening the tubing with the knob, maintain a uniform gap (approx. 2 mm) on both sides of the holder.
 - When the tubing is curved, straighten it out before using it.
 - The tubing may slip if there is oil or dust, etc., on the holder. Remove the contamination using alcohol or another suitable cleaner.

Use of Tubing

Caution

1. Refer to the applicable tubing sizes shown below for tubing to be used.

Applicable tubing sizes

	Connection tubing size	O.D. (mm)		Internal thickness (mm)	
		Standard size	Tolerance	Standard size	Tolerance
Metric sizes	ø3 x ø2	3.0	+0.2 -0.1	0.5	±0.06
	ø4 x ø3	4.0			
	ø6 x ø4	6.0			
	ø8 x ø6	8.0		1.0	±0.1
	ø10 x ø8	10.0			
	ø12 x ø10	12.0			
	ø19 x ø16	19.0			
ø25 x ø22	25.0	+0.3 -0.1	1.5	±0.15	
1/8" x 0.086"	3.18	+0.2 -0.1			0.5
3/16" x 1/8"	4.75		0.8		
1/4" x 5/32"	6.35		1.2	±0.12	
3/8" x 1/4"	9.53				
1/2" x 3/8"	12.7		1.6	±0.15	
3/4" x 5/8"	19.0				
1" x 7/8"	25.4				
1 1/4" x 1 1/4"	31.75	±0.25	1.9	±0.2	
1 1/2" x 1.33"	38.1	±0.2	2.2	±0.2	

Return of Product

Warning

If the product to be returned is contaminated or is possibly contaminated with substances that are harmful to humans, for safety reasons, please contact SMC beforehand and then employ a specialist cleaning company to decontaminate the product. After the decontamination prescribed above has been carried out, submit a Product Return Request Sheet or the Detoxification/Decontamination Certificate to SMC and await SMC's approval and further instructions before attempting to return the item.
Please refer to the International Chemical Safety Cards (ICSC) for a list of harmful substances.
If you have any further questions, please don't hesitate to contact your SMC sales representative.

LVC

LVA

LVH

LVD

LVQ

LVP

LVW

LQ1

LQ3

LVN

LQHB

TL
TILTLM
TILMTD
TIDTH
TIH

Fluoropolymer Tubing Variations

TL/TIL/TLM/TILM/TD/TID/TH/TIH Series



High Purity Fluoropolymer Tubing

TL/TIL Series

(Material) Super PFA

It is suitable for applications which require a highly smooth internal surface and small amount of elution of fluorine ions.

* It has heat and chemical resistance equivalent to PFA. **P.948**



Fluoropolymer Tubing (PFA)

TLM/TILM Series

(Material) PFA

The material consists of a good chemical resistant fluoropolymer. This also has good heat resistance, and it is suitable for a wide range of applications. **P.949**

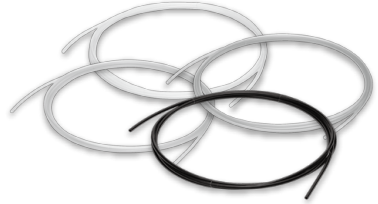

Soft Fluoropolymer Tubing

TD/TID Series

(Material) Modified PTFE

Flexibility improved by approx. 20%

(Compared with SMC TL/TIL Series)

Suitable for applications which require flexibility. **P.952**



FEP Tubing (Fluoropolymer)

TH/TIH Series

(Material) FEP

This has better resistance in chemical environments. **P.954**



LVC

LVA

LVH

LVD

LVQ

LVP

LVW

LQ1

LQ3

LVN

LQHB

TL

TIL

TLM

TILM

TD

TID

TH

TIH

Series		TL/TIL	TLM/TILM	TD/TID	TH/TIH
Material		Super PFA	PFA	Modified PTFE	FEP
Chemical resistance		○	○	◎	○
Heat resistance		260°C	260°C	260°C	200°C
Flexibility		△	△	○	△
Ion elution		◎	○	○	○
Internal smoothness		○	△	○	◎
Fluid		Chemicals, Deionized water	Chemicals, Deionized water	Air, Water, Inert gas	
Tubing O.D.	Metric	ø4 to ø19	ø2 to ø25	ø4 to ø12	ø4 to ø12
	Inch	1/8" to 1"	1/8" to 1 1/4"	1/8" to 1/2"	1/8" to 3/4"
Color		Translucent	Translucent, Red, Blue, Black	Translucent	Translucent, Red, Blue, Black
Applicable fitting series	One-touch fittings	—	KQ2, KQG2, KP, KP□	—	KQ2, KQG2, KP, KP□
	Miniature fittings	—	M, MS (Hose nipple type)	M, MS (Hose nipple type)	M, MS (Hose nipple type)
	Insert fittings	—	KF, KFG2	KF, KFG2	KF, KFG2
	Fluoropolymer fittings	LQ series	LQ series	LQ series	LQ series

◎: Very good ○: Good △: Moderate

The comparison table shown above was prepared based on a relative comparison taking the characteristics of each fluoropolymer tubing into consideration.

High Purity Fluoropolymer Tubing TL/TIL Series

Material: Super PFA

Series and Specifications

		Metric sizes (TL series)						Inch sizes (TIL series)							
Tubing model		TL0403	TL0604	TL0806	TL1210	TL1916	TIL01	TILB01	TIL05	TIL07	TIL11	TIL13	TIL19	TIL25	
Nominal diameter		—	—	—	—	—	1/8"	1/8"	3/16"	1/4"	3/8"	1/2"	3/4"	1"	
Tubing size		ø4 x ø3	ø6 x ø4	ø8 x ø6	ø10 x ø8	ø12 x ø10	ø19 x ø16	1/8" x 0.086"	1/8" x 1/16"	3/16" x 1/8"	1/4" x 5/32"	3/8" x 1/4"	1/2" x 3/8"	3/4" x 5/8"	1" x 7/8"
O.D. (mm)	Basic diameter	4	6	8	10	12	19	3.18	3.18	4.75	6.35	9.53	12.7	19.05	25.4
	Tolerance	±0.1				±0.1				±0.1				±0.1	
Thickness (mm)	Basic diameter	0.5		1		1.5		0.5		0.8		1.2		1.6	
	Tolerance	±0.05		±0.1		±0.15		±0.05		±0.08		±0.12		±0.15	
Bundle	10 m	—	—	—	●	●	●	—	—	—	—	●	●	—	—
	20 m	●	●	●	●	●	●	—	—	—	—	●	●	●	●
	50 m	●	●	●	●	●	●	—	—	—	—	●	●	●	●
	100 m	●	●	●	●	●	●	—	—	—	—	●	●	●	—
	16 m (50 ft)	—	—	—	—	—	—	●	●	●	●	●	●	●	—
33 m (100 ft)	—	—	—	—	—	—	●	●	●	●	●	●	●	●	—
Straight pipe	2 m	●	●	●	●	●	●	—	●	●	●	●	●	●	●
Color		Translucent (color of material)													
Applicable fluid		Refer to the applicable fluid in page 957.													
Applicable fittings		Fluoropolymer Fittings LQ series													
Max. operating pressure (MPa)	20°C	1.0	1.0	1.0	0.9	0.7	0.6	1.0	1.0	1.0	1.0	1.0	1.0	0.7	0.5
	100°C	0.45	0.64	0.43	0.33	0.27	0.24	0.59	0.92	0.62	0.73	0.62	0.43	0.26	0.19
	200°C	0.21	0.29	0.20	0.15	0.12	0.11	0.27	0.42	0.28	0.34	0.28	0.20	0.12	0.09
Burst pressure (MPa at 20°C)	260°C	0.09	0.12	0.08	0.06	0.05	0.05	0.11	0.17	0.12	0.14	0.12	0.08	0.05	0.04
	20°C	4.9	6.9	4.7	3.6	2.9	2.6	6.4	9.9	6.7	7.9	6.7	4.6	2.8	2.0
Min. bending radius (mm)	Recommender radius	35	35	60	100	130	220	20	10	25	35	60	95	220	400
	Tube close bend radius	20	20	40	65	110	160	12	6	20	20	30	60	160	290
Max. operating temperature (Fixed use)		260°C													
Material		Super PFA													

Note 1) When using the product at a temperature other than those shown in the table above, use it at a maximum operating pressure or less that is calculated from the following formula.

(Max. operating pressure) = 14 x (burst pressure drop coefficient) x (burst pressure at 20°C)

Note 2) When using a fluid in liquid form, the surge pressure must be no more than the maximum operating pressure. A surge pressure higher than the maximum operating pressure can cause breakage of the fitting or bursting of the tubing. Furthermore, abnormal temperature rise caused by adiabatic compression may result in the tube bursting.

Note 3) Do not use this product in a manner in which the tube is not fixed. Observe the lesser value of the maximum operating pressure between the tubing and fitting. A material change over a long duration or due to high-temperature may cause leakage. Perform periodic maintenance and replace with a new product immediately when abnormalities are detected. (Refer to "Maintenance" of the tubing precautions on page 960.)

Note 4) For other precautions, refer to "Fittings & Tubing Precautions" in Best Pneumatics No. 7. When using the fluoropolymer fittings, refer to the precautions on pages 944 and 945.

Note 4) Minimum bending radius is measured as shown left as representative values. • Use a tube above the recommended minimum bending radius. • The tube may be bent if used under the recommended minimum bending radius. Therefore, refer to the tube close bend radius and make sure that the tube is not bent or flattened. • Please note that the tube close bend radius is not warranted because of the value when 2R is measured by the method in the right figure if the tube is bent or flattened, etc. • The minimum bending radius shown above does not apply to the straight pipe (2 m).

Note 5) As for other commercial items, there are some cases it is not able to connect due to tolerance of dimensions.

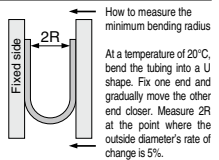

Burst pressure drop curve

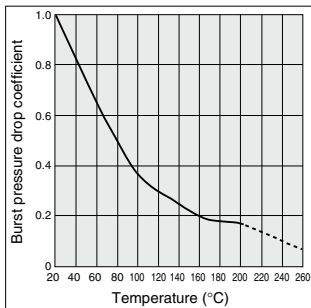

How to Order

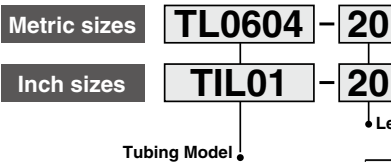

Length Applicable to both metric and inch size

Symbol	Type	Length
10	Roll	10 m
20		20 m
50		50 m
100		100 m
2S	Straight	2 m

Eluting fluorine ion amount ^{Note 6)} (µg/g)

Type	Fluorine ion
Eluting amount	0.1 or less

A 15 g piece of fluororesin tubing is cut off, washed in DI water (purer water) and immersed in 15 mL of 25% methyl alcohol extract at room temperature for 24 hours. Then the extract is diluted with DI water (purer water) to be subjected to a quantitative analysis of fluorine ions.

Eluting metal ion amount ^{Note 6)} (ng/cm²)

Type	Al	Fe	Ni	Na	Ca
Eluting amount	4.5	0.3	0.2	7.1	1.3

The interior of the fluororesin tubing is washed with super deionized water. Approximately 20 µg of super high purity hydrofluoric acid (48%) is measured and injected into the tubing. The interior wall of the tubing is immersed at normal temperature for one week with both ends of the tubing plugged. Then the extract is diluted with super deionized water to be subjected to a quantitative analysis on Al, Fe, Ni, Na and Ca by the stripping method.

Length Applicable to inch size only

Symbol	Type	Length
16	Roll	16 m (50 ft)
33		33 m (100 ft)

Please refer to the "Series and Specifications" above, as the tubing length differs depending on each size.

Note 6) Figures shown in tables are representative values, not guaranteed values.

Fluoropolymer Tubing **PFA**

TLM/TILM Series

RoHS

Max. operating temperature: 260°C

22 size variations

Metric size $\varnothing 2$ to $\varnothing 25$ (13 sizes)

Length per roll 10 m, 20 m, 50 m, 100 m

Straight 2 m

Inch size 1/8" to 1 1/4" (9 sizes)

Length per roll 10 m, 20 m, 50 m, 100 m
16 m (50 ft), 33 m (100 ft)

Straight 2 m

4 color variations

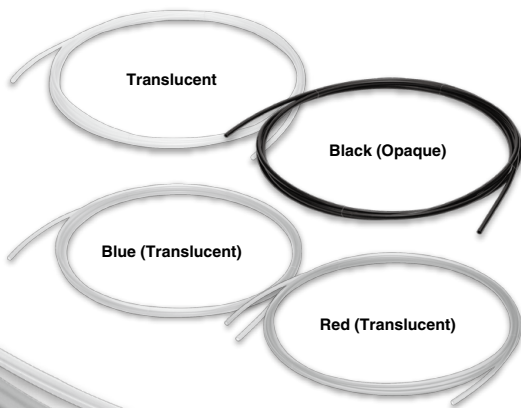

Applications

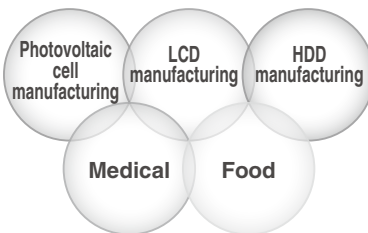

Compatible with Food Sanitation Law

- Compatible with the test conforming to Japan's Food Sanitation Law based on the 370th notice given by the Ministry of Health and Welfare in 1959.
- Complies with FDA (Food and Drug Administration) §177-1550 dissolution test.

LVC

LVA

LVB

LVD

LVQ

LVP

LVV

LQ1

LQ3

LVN

LQHB

TL
TIL

TLM
TILM

TD
TID

TH
TIH

Fluoropolymer Tubing (PFA)

Metric Size

TLM Series

RoHS

Series

Size			Metric size											
Model	TLM0201	TLM0302	TLM0425	TLM0403	TLM0604	TLM0806	TLM1075	TLM1008	TLM1209	TLM1210	TLM1613	TLM1916	TLM2522	
Tubing size	ø2 x ø1	ø3 x ø2	ø4 x ø2.5	ø4 x ø3	ø6 x ø4	ø8 x ø6	ø10 x ø7.5	ø10 x ø8	ø10 x ø10	ø12 x ø9	ø12 x ø10	ø16 x ø13	ø19 x ø16	ø25 x ø22
O.D. (mm)	2	3	4	4	6	8	10	10	12	12	16	19	25	
I.D. (mm)	1	2	2.5	3	4	6	7.5	8	9	10	13	16	22	

Length per roll	Color	Symbol	TLM0201	TLM0302	TLM0425	TLM0403	TLM0604	TLM0806	TLM1075	TLM1008	TLM1209	TLM1210	TLM1613	TLM1916	TLM2522	
Roll	10 m	Translucent	N	•	•	•	•	•	•	•	•	•	•	•	•	
	20 m	Translucent	N	•	•	•	•	•	•	•	•	•	•	•	•	•
		Red (Translucent)	R	•	•	•	•	•	•	•	•	•	•	•	•	•
		Blue (Translucent)	BU	•	•	•	•	•	•	•	•	•	•	•	•	•
		Black (Opaque)	B	•	•	•	•	•	•	•	•	•	•	•	•	•
	50 m	Translucent	N	•	•	•	•	•	•	•	•	•	•	•	•	
100 m	Translucent	N	•	•	•	•	•	•	•	•	•	•	•	•		
Straight	2 m	Translucent	N	•	•	•	•	•	•	•	•	•	•	•	•	

Inch O.D. size 5/32"	Inch O.D. size 5/16"	O.D. 3.2 mm is available in ø 1/8 inch (3.18 mm) tubing. For details, refer to the table "Series" on page 951.
-------------------------	-------------------------	---

Specifications

Fluid (Note 1) 2) 3) and applicable fittings (Note 1) 2) 3)	Fluid: Refer to "Applicable Fluid List" on page 958. Fittings: Fluoropolymer fittings LQ series Fluid: Air, Water, Inert gas Fittings: One-touch fittings KQ2, KQG2, Clean One-touch fittings KP, KP□ Insert fittings KF, KFG2, Miniature fittings M, MS (Hose nipple type)												
Max. operating pressure (MPa)	Refer to the max. operating pressure curve.												
Min. bending radius (mm) (Note 4)	10	20	20	35	35	60	95	100	100	130	160	220	400
Tube close bend radius	7	15	15	20	20	40	60	65	65	110	130	160	290
Max. operating temperature	260°C												
Material	PFA (Tetrafluoroethylene perfluoroalkoxy vinyl ether copolymer)												

Note 1) Fluid varies depending on the applicable fittings.

Note 2) When using a liquid fluid, the surge pressure must not exceed the maximum operating pressure. If the surge pressure exceeds the maximum operating pressure, it will result in damage to fittings and tubes. Furthermore, abnormal temperature rise caused by adiabatic compression may result in the tube bursting.

Note 3) Do not use this product in a manner in which the tube is not fixed. Observe the lesser value of the maximum operating pressure between the tubing and fitting. A material change over a long duration or due to high-temperature may cause leakage. Perform periodic maintenance and replace with a new product immediately when abnormalities are detected. (Refer to "Maintenance" of the tubing precautions on page 960.)

For other precautions, refer to "Fittings & Tubing Precautions" in Best Pneumatics No. 7. When using the fluoropolymer fittings, refer to the precautions on pages 944 and 945.

Note 4) Minimum bending radius is measured as shown left as representative values.

- Use a tube above the recommended minimum bending radius.
- The tube may be bent if used under the recommended minimum bending radius. Therefore, refer to the tube close bend radius and make sure that the tube is not bent or flattened.
- Please note that the tube close bend radius is not warranted because of the value when 2R is measured by the method in the right figure if the tube is bent or flattened, etc.
- The minimum bending radius shown above does not apply to the straight pipe (2 m).

How to measure the minimum bending radius

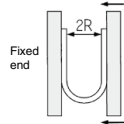

At a temperature of 20°C, bend the tubing into a U shape. Fix one end and gradually move the other end closer. Measure 2R at the point where the outside diameter's rate of change is 5%.

Max. Operating Pressure

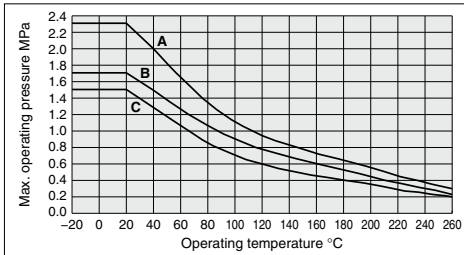

Group	Model	Max. operating pressure (MPa)			
		20°C	100°C	200°C	260°C
A	TLM0201	2.3	1.1	0.55	0.3
	TLM0425	1.7	0.9	0.45	0.23
C	TLM0302	1.5	0.7	0.35	0.2
	TLM0604				
	TLM0403				
D	TLM0806	1	0.5	0.25	0.15
	TLM1075				
	TLM1209				
	TLM1008				
E	TLM1613	0.7	0.35	0.17	0.11
	TLM1008				
F	TLM1210	0.6	0.3	0.15	0.1
	TLM1916				
G	TLM2522	0.4	0.2	0.1	0.05

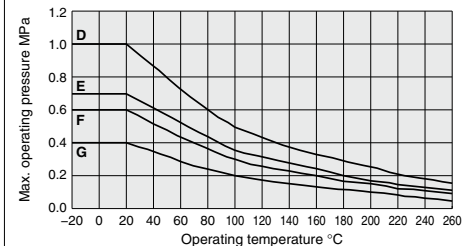

How to Order

Metric size

TLM0425 N - 20

Tubing designation

Color indication

Symbol	Color
N	Translucent (Material color)
R	Red (Translucent)
BU	Blue (Translucent)
B	Black (Opaque)

Length per roll

Symbol	Type	Length
10	Roll	10 m
20		20 m
50		50 m
100		100 m
2S		Straight

Note) Refer to the table "Series" above, as the tubing length differs depending on each size.

Fluoropolymer Tubing (PFA)

Inch Size

TILM Series



Series

Size			Inch size								
Model	TILM01	TILMB01	TILM05	TILM07	TILM11	TILM13	TILM19	TILM25	TILM32		
Tubing size			1/8" x 0.086"	1/8" x 1/16"	3/16" x 1/8"	1/4" x 5/32"	3/8" x 1/4"	1/2" x 3/8"	3/4" x 5/8"	1" x 7/8"	1 1/4" x 1 1/16"
O.D.	inch	1/8"	1/8"	3/16"	1/4"	3/8"	1/2"	3/4"	1"	1 1/4"	
	mm	3.18		4.75	6.35	9.53	12.7	19.05	25.4	31.75	
I.D.	inch	0.086"	1/16"	1/8"	5/32"	1/4"	3/8"	5/8"	7/8"	1 1/16"	
	mm	2.18	1.58	3.15	3.95	6.33	9.5	15.85	22.2	27.95	

Length per roll	Color	Symbol	TILM01	TILMB01	TILM05	TILM07	TILM11	TILM13	TILM19	TILM25	TILM32
10 m	Translucent	N	●	●	●	●	●	●	●	●	●
	Translucent	N	●	●	●	●	●	●	●	●	●
	Red (Translucent)	R	●	●	●	●	●	●	●	●	●
	Blue (Translucent)	BU	●	●	●	●	●	●	●	●	●
	Black (Opaque)	B	●	●	●	●	●	●	●	●	●
	50 m	Translucent	N	●	●	●	●	●	●	●	●
100 m	Translucent	N	●	●	●	●	●	●	●	●	●
	Translucent	N	●	●	●	●	●	●	●	●	●
16 m (50 ft)	Translucent	N	●	●	●	●	●	●	●	●	
33 m (100 ft)	Translucent	N	●	●	●	●	●	●	●	●	
Straight	2 m	Translucent	N	●	●	●	●	●	●	●	

Metric O.D. size	3.2
------------------	-----

O.D. 5/32" is available in ø4 metric tubing, and O.D. 5/16" is available in ø8 metric tubing. For details, refer to the table "Series" on page 950.

Specifications

Fluid ^{Note 1) 2) 3)} and applicable fittings ^{Note 1) 2) 3)}	Fluid: Refer to "Applicable Fluid List" on page 958. Fittings: Fluoropolymer fittings LQ series									
Max. operating pressure (MPa)	Fluid: Air, Water, Inert gas Fittings: One-touch fittings KQ2, KQG2, Insert fittings KFG2									
Min. bending radius (mm) ^{Note 4)}	20	10	25	35	60	95	220	400	500	
Recommended radius	12	6	20	20	30	60	160	290	360	
Tube close bend radius										
Max. operating temperature	260°C									
Material	PFA (Tetrafluoroethylene perfluoroalkoxy vinyl ether copolymer)									

Note 1) Fluid varies depending on the applicable fittings.

Note 2) When using a liquid fluid, the surge pressure must not exceed the maximum operating pressure. If the surge pressure exceeds the maximum operating pressure, it will result in damage to fittings and tubes. Furthermore, abnormal temperature rise caused by adiabatic compression may result in the tube bursting.

Note 3) Do not use this product in a manner in which the tube is not fixed. Observe the lesser value of the maximum operating pressure between the tube and fitting. A material change over a long duration or due to high-temperature may cause leakage. Perform periodic maintenance and replace with a new product immediately when abnormalities are detected. (Refer to "Maintenance" of the tubing precautions on page 960.) For other precautions, refer to "Fittings & Tubing Precautions" in Best Pneumatics No. 7. When using the fluoropolymer fittings, refer to the precautions on pages 944 and 945.

Note 4) Minimum bending radius is measured as shown left as representative values.

- Use a tube above the recommended minimum bending radius.
- The tube may be bent if used under the recommended minimum bending radius. Therefore, refer to the tube close bend radius and make sure that the tube is not bent or flattened.
- Please note that the tube close bend radius is not warranted because of the value when 2R is measured by the method in the right figure if the tube is bent or flattened, etc.
- The minimum bending radius shown above does not apply to the straight pipe (2 m).

How to measure the minimum bending radius

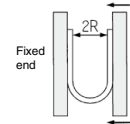

At a temperature of 20°C, bend the tubing into a U shape. Fix one end and gradually move the other end closer. Measure 2R at the point where the outside diameter's rate of change is 5%.

Max. Operating Pressure

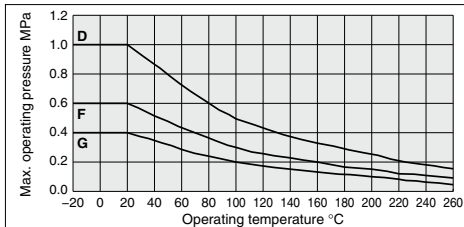
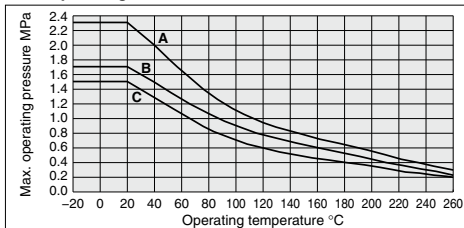

Group	Model	Max. operating pressure (MPa)			
		20°C	100°C	200°C	260°C
A	TILMB01	2.3	1.1	0.55	0.3
B	TILM07	1.7	0.9	0.45	0.23
C	TILM05 TILM11	1.5	0.7	0.35	0.2
D	TILM01 TILM13	1	0.5	0.25	0.15
F	TILM19	0.6	0.3	0.15	0.1
G	TILM25 TILM32	0.4	0.2	0.1	0.05

How to Order

Inch size

TILM01 N - 20

Tubing designation

Symbol	Color
N	Translucent (Material color)
R	Red (Translucent)
BU	Blue (Translucent)
B	Black (Opaque)

Length per roll

Symbol	Type	Length
10	Roll	10 m
20		20 m
50		50 m
100		100 m
16		16 m (50 ft)
33		33 m (100 ft)
2S	Straight	2 m

Note) Refer to the table "Series" above, as the tubing length differs depending on each size.

Soft Fluoropolymer Tubing

Metric Size

TD Series

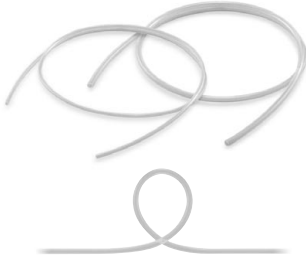

Flexibility: Improved by approx. 20%

* SMC comparison (Fluoropolymer tubing, TL/TIL series)

Compatible with the Food Sanitation Law

- Compatible with the test conforming to the Food Sanitation Law based on the 370th notice given by the Ministry of Health and Welfare in 1959.
- Complies with FDA (Food and Drug Administration) §177-1550 dissolution test.

Operating Temperature: Max. 260°C

It varies depending on the operating pressure. Refer to the graph for the maximum operating pressure.

How to measure the minimum bending radius

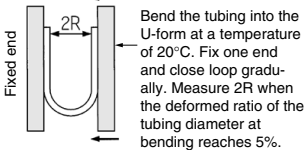

Model/Specifications

Size		Metric size				
Model		TD0425	TD0604	TD0806	TD1075	TD1209
Tubing O.D. (mm)		4	6	8	10	12
Tubing I.D. (mm)		2.5	4	6	7.5	9
Roll	10 m	●	●	●	●	●
	20 m	●	●	●	●	●
Color	Translucent (material color)					
Applicable fluid	Refer to the applicable fluid in page 957.					
Fluid ^{Note 1)}	Air, Water ^{Note 1)} , Inert gas					
Applicable fittings ^{Note 2)}	Insert Fittings KF series Stainless Steel 316 Insert Fittings KFG series Miniature fittings M, MS series (Hose nipple type) Fluoropolymer fitting LQ series					
Max. operating pressure (MPa)	20°C	1.6	1.4	0.9	0.9	0.9
	100°C	0.9	0.7	0.5	0.5	0.5
	200°C	0.45	0.35	0.25	0.25	0.25
	260°C	0.23	0.2	0.15	0.15	0.15
Min. bending radius (mm) ^{Note 3)}	Recommended radius	15	25	45	55	75
	Tube close bend radius	8	16	31	35	41
Max. operating temperature (fixed usage)	260°C					
Material	Modified PTFE (Polytetrafluoroethylene resin)					

Note 1) When using a liquid fluid, the surge pressure must be under the maximum operating pressure. If the surge pressure exceeds the maximum operating pressure, it will result in damage to fittings and tubing. Furthermore, abnormal temperature rise caused by adiabatic compression may result in the tubing bursting.

Note 2) Do not use this product in a manner in which the tubing is not fixed.

Observe the lesser value of the maximum operating pressure between the tubing and fittings. A material change over a long duration or due to high-temperature may cause leakage. Perform periodic maintenance and replace with a new product immediately when abnormalities are detected.

(Refer to "Maintenance" of the tubing precautions on page 960.)

For other precautions, refer to "Fittings & Tubing Precautions" in Best Pneumatics No. 7.

When using the fluoropolymer fittings, refer to the precautions on pages 944 and 945.

Note 3) The minimum bending radius is the representative value measured as shown in the left figure.

• Use a tube above the recommended minimum bending radius.

• The tubing may be bent if used under the recommended minimum bending radius.

Therefore, refer to the tube close bend radius and make sure that the tubing is not bent or flattened.

• Please note that the tube close bend radius is not warranted because of the value when 2R is measured by the method in the left figure if the tubing is bent or flattened, etc.

Maximum Operating Pressure

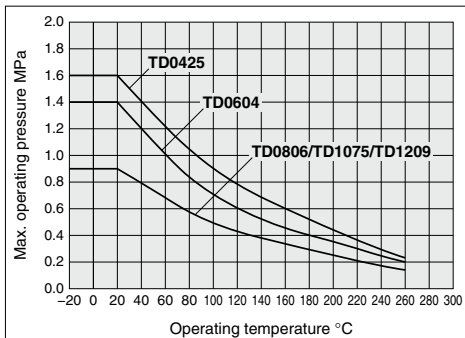

How to Order

Metric size

TD0425 - 10

• Length per roll

Symbol	Length
10	10 m roll
20	20 m roll

• Tubing model

Soft Fluoropolymer Tubing

Inch Size

TID Series

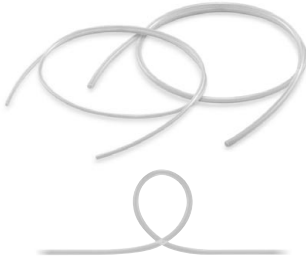

Flexibility: Improved by approx. 20%

* SMC comparison (Fluoropolymer tubing, TL/TIL series)

Compatible with the Food Sanitation Law

- Compatible with the test conforming to the Food Sanitation Law based on the 370th notice given by the Ministry of Health and Welfare in 1959.
- Complies with FDA (Food and Drug Administration) §177-1550 dissolution test.

Operating Temperature: Max. 260°C

It varies depending on the operating pressure. Refer to the graph for the maximum operating pressure.

How to measure the minimum bending radius

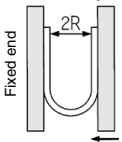

Bend the tubing into the U-form at a temperature of 20°C. Fix one end and close loop gradually. Measure 2R when the deformed ratio of the tubing diameter at bending reaches 5%.

Model/Specifications

Size		Inch size				
Model		TID01	TID05	TID07	TID11	TID13
Tubing O.D.	inch	1/8"	3/16"	1/4"	3/8"	1/2"
	mm	3.18	4.75	6.35	9.53	12.7
Tubing I.D.	inch	0.086"	0.124" (1/8")	0.156" (5/32")	0.25" (1/4")	0.374" (3/8")
	mm	2.18	3.15	3.95	6.33	9.5
Roll	8 m (25 ft)	●	●	●	●	●
	16 m (50 ft)	●	●	●	●	●
Color		Translucent (material color)				
Applicable fluid		Refer to the applicable fluid in page 957.				
Fluid ^{Note 1)}		Air, Water ^{Note 1)} , Inert gas				
Applicable fittings ^{Note 2)}		Fluoropolymer fitting LQ series				
Max. operating pressure (MPa)	20°C	1.4	1.4	1.6	1.4	0.9
	100°C	0.7	0.7	0.9	0.7	0.5
	200°C	0.35	0.35	0.45	0.35	0.25
	260°C	0.2	0.2	0.23	0.2	0.15
Min. bending radius (mm) ^{Note 3)}	Recommended radius	15	20	25	40	75
	Tube close bend radius	9	10	15	23	42
Max. operating temperature (fixed usage)		260°C				
Material		Modified PTFE (Polytetrafluoroethylene resin)				

Note 1) When using a liquid fluid, the surge pressure must be under the maximum operating pressure. If the surge pressure exceeds the maximum operating pressure, it will result in damage to fittings and tubing. Furthermore, abnormal temperature rise caused by adiabatic compression may result in the tubing bursting.

Note 2) Do not use this product in a matter in which the tubing is not fixed.

Observe the lesser value of the maximum operating pressure between the tubing and fittings. A material change over a long duration or due to high-temperature may cause leakage. Perform periodic maintenance and replace with a new product immediately when abnormalities are detected.

(Refer to "Maintenance" of the tubing precautions on page 960.)

For other precautions, refer to "Fittings & Tubing Precautions" in Best Pneumatics No. 7.

When using the fluoropolymer fittings, refer to the precautions on pages 944 and 945.

Note 3) The minimum bending radius is the representative value measured as shown in the left figure.

• Use a tube above the recommended minimum bending radius.

• The tubing may be bent if used under the recommended minimum bending radius.

• Therefore, refer to the tube close bend radius and make sure that the tubing is not bent or flattened.

• Please note that the tube close bend radius is not warranted because of the value when 2R is measured by the method in the left figure if the tubing is bent or flattened, etc.

Maximum Operating Pressure

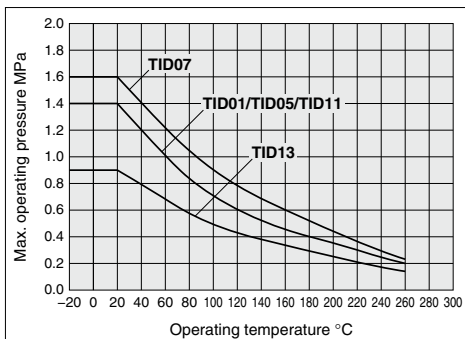

How to Order

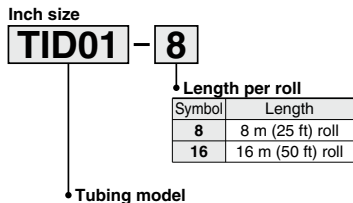

LVC

LVA

LVB

LVD

LVB

LVP

LVV

LQ1

LQ3

LVN

LQHB

TL

TIL

TLM

TID

TIH

TIH

FEP Tubing (Fluoropolymer)

Metric Size

TH Series

RoHS



Operating Temperature: Max. 200°C
It varies depending on the operating pressure. Refer to the graph for the maximum operating pressure.

Compatible with the Food Sanitation Law

- Compatible with the test conforming to the Food Sanitation Law based on the 370th notice given by the Ministry of Health and Welfare in 1959.
- Complies with FDA (Food and Drug Administration) §177-1550 dissolution test.

How to measure the minimum bending radius.

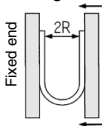

At a temperature of 20°C, bend the tubing into a U shape. Fix one end and gradually move the other end closer. Measure 2R at the point where the outside diameter's rate of change is 5%.

Max. Operating Pressure

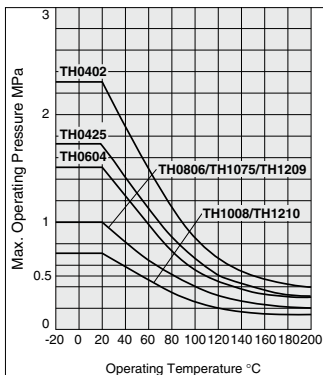

Note) The maximum operating pressure varies dependant on the I.D. bore size even if the O.D. is the same.

Series

●-20 m roll □-100 m roll

		Metric size								
Model		TH0402	TH0425	TH0604	TH0806	TH1075	TH1008	TH1209	TH1210	
Tubing O.D. (mm)		4	4	6	8	10	10	12	12	
Tubing I.D. (mm)		2	2.5	4	6	7.5	8	9	10	
Color	Symbol									
Translucent	N	●	●	●	●	●	●	●	●	
Red (Translucent)	R	●	●	●	●	●	●	●	●	
Blue (Translucent)	BU	●	●	●	●	●	●	●	●	
Black (Opaque)	B	●	●	●	●	●	●	●	●	
		Inch nominal size 5/32"			Inch nominal size 5/16"					

Specifications

Fluid	Air, Water ^{Note 1)} , Inert gas							
Applicable fittings ^{Note 2)}	One-touch fittings, Insert fittings Fluoropolymer fittings: LQ series ^{Note 3)} Miniature fittings: M, MS series (Hose nipple type)							
Max. operating pressure (MPa)	20°C	2.3	1.7	1.5	1	0.7	1	0.7
	100°C	0.85	0.6	0.55	0.4	0.25	0.4	0.25
	200°C	0.4	0.3	0.3	0.2	0.1	0.2	0.1
Refer to the max. operating pressure curve.								
Min. bending radius (mm) ^{Note 4)}	Recommended radius	15	20	35	60	95	100	130
	Tube close bend radius	10	15	20	40	60	65	110
Operating temperature	Air, Inert gas: -20 to 200°C Water: 0 to 100°C (No freezing)							
Material	FEP (Fluorinated Ethylene Propylene Resin)							

Note 1) When using a fluid in liquid form, the surge pressure must not exceed the maximum operating pressure. A surge pressure higher than the maximum operating pressure can cause breakage of the fittings, or rupture of the tubing. Furthermore, an abnormal temperature increase due to adiabatic compression can also result in ruptured tubing.

Note 2) Do not use in locations where the FEP tubing will move.

Be sure to operate under the maximum operating pressure conditions using the lower maximum operating specification of either the tubing or fittings.

After long term use or under high temperatures, some fittings leakage may occur due to material deterioration with age. Perform periodic inspections, and if any leakage is detected, replace with a new product immediately.

When the insert and miniature fittings are used over extended periods of time, it may cause leakage due to the material deterioration of age. In such a case, give an additional tightening to the tube connection part. If leakage still occurs after giving an additional tightening, replace the fitting with a new product. For other precautions, refer to "Fittings & Tubing Precautions" in Best Pneumatics No. 7. When using the fluoropolymer fittings, refer to the precautions on pages 944 and 945. Select the size after confirming O.D. and I.D.

Note 3) TH0402, TH0425, TH1075 and TH1209 are not available because of different internal diameters.

Note 4) The minimum bending radius is the representative value measured as shown in the left figure.

- Use a tube above the recommended minimum bending radius.
- The tubing may be bent if used under the recommended minimum bending radius. Therefore, refer to the tube close bend radius and make sure that the tubing is not bent or flattened.
- Please note that the tube close bend radius is not warranted because of the value when 2R is measured by the method in the left figure if the tubing is bent or flattened, etc.

How to Order

Metric size

TH0604 N - 20

Indication of tubing model

Color indication

Length per roll

Symbol	Color
N	Translucent (Material color)
R	Red (Translucent)
BU	Blue (Translucent)
B	Black (Opaque)

Symbol	Roll size
20	20 m roll
100 ^{Note)}	100 m roll

Note) 100 m roll is available with translucent (color indication: N) only.

Made to Order

(Please contact SMC for specifications in detail, dimensions, delivery and specifications other than those mentioned above.)

Reinforced corrugated cardboard specification longer length reel

ø6, Translucent only: Suffix "-X64" to the end of part number. Ex.) TH0604N-500-X64

Made to Order Availability

Part no.	Length	Model	Color
X64	250 m reel	TH0604N	Translucent
	500 m reel		

Reinforced corrugated cardboard specification: Longer length reel/-X64

Dimensions

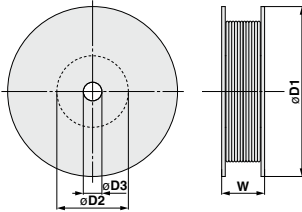

Dimensions

Model	øD1	øD2	øD3	W	Weight (kg)
TH0604N-250-X64	475	200	52	120	9.4
TH0604N-500-X64	475	200	52	220	18.5

- LVK
- LVA
- LVB
- LVC
- LVD
- LVQ
- LVP
- LVW
- LQ1
- LQ3
- LVN
- LQHB
- TL
- TIL
- TLM
- TILM
- TD
- TID
- TH
- TIH

FEP Tubing (Fluoropolymer)

Inch Size

TIH Series

RoHS



Operating Temperature: Max. 200°C
It varies depending on the operating pressure. Refer to the graph for the maximum operating pressure.

Compatible with the Food Sanitation Law

- Compatible with the test conforming to the Food Sanitation Law based on the 370th notice given by the Ministry of Health and Welfare in 1959.
- Complies with FDA (Food and Drug Administration) § 177-1550 dissolution test.

How to measure the minimum bending radius.

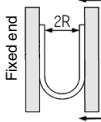

At a temperature of 20°C, bend the tubing into a U shape. Fix one end and gradually move the other end closer. Measure 2R at the point where the outside diameter's rate of change is 5%.

Max. Operating Pressure

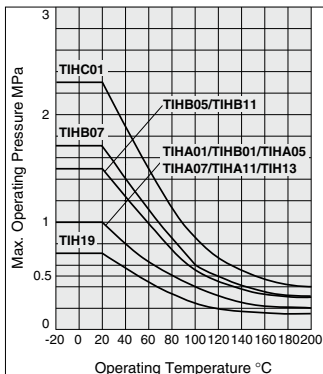

Note) The maximum operating pressure varies dependant on the I.D. bore size even if the O.D. is the same.

Series

●-16 m (50 ft) roll □-33 m (100 ft) roll

Model		Inch size										
		TIHA01	TIHB01	TIHC01	TIHA05	TIHB05	TIHA07	TIHB07	TIHA11	TIHB11	TIH13	TIH19
Tubing O.D.	inch	1/8"			3/16"		1/4"		3/8"		1/2"	3/4"
	mm	3.18			4.75		6.35		9.53		12.7	19.05
Tubing I.D.	inch	0.093"	0.086"	0.065"	0.137"	0.124" (1/8")	0.18"	0.156" (5/32")	0.275" (1/4")	0.25" (3/8")	0.374" (5/8")	0.624"
	mm	2.36	2.18	1.65	3.48	3.15	4.57	3.95	6.99	6.33	9.5	15.85

Color	Symbol	TIHA01	TIHB01	TIHC01	TIHA05	TIHB05	TIHA07	TIHB07	TIHA11	TIHB11	TIH13	TIH19
Translucent	N	●	●	●	●	●	●	●	●	●	●	●
Red (Translucent)	R	●	●	●	●	●	●	●	●	●	●	●
Blue (Translucent)	BU	●	●	●	●	●	●	●	●	●	●	●
Black (Opaque)	B	●	●	●	●	●	●	●	●	●	●	●

Specifications

Fluid	Air, Water ^{Note 1)} , Inert gas											
Applicable fittings ^{Note 2)}	One-touch fittings, Fluoropolymer fittings: LQ series ^{Note 3)}											
Max. operating pressure (MPa)	20°C	1	2.3	1	1.5	1	1.7	1	1.5	1	0.7	
	100°C	0.4	0.85	0.4	0.55	0.4	0.6	0.4	0.55	0.4	0.25	
	200°C	0.2	0.4	0.2	0.3	0.2	0.3	0.2	0.3	0.2	0.1	
Refer to the max. operating pressure curve.												
Min. bending radius (mm) ^{Note 4)}	Recommended radius	25	20	10	35	25	55	35	85	60	95	220
	Tube close bend radius	20	12	7	25	20	35	20	55	30	60	160
Operating temperature	Air, Inert gas: -20 to 200°C Water: 0 to 100°C (No freezing)											
Material	FEP (Fluorinated Ethylene Propylene Resin)											

- Note 1) When using a fluid in liquid form, the surge pressure must not exceed the maximum operating pressure. A surge pressure higher than the maximum operating pressure can cause breakage of the fittings, or rupture of the tubing. Furthermore, an abnormal temperature increase due to adiabatic compression can also result in ruptured tubing.
- Note 2) Do not use in locations where the FEP tubing will move.
Be sure to operate under the maximum operating pressure conditions using the lower maximum operating specification of either the tubing or fittings.

After long term use or under high temperatures, some fittings leakage may occur due to material deterioration with age. Perform periodic inspections, and if any leakage is detected, replace with a new product immediately. When the insert and miniature fittings are used over extended periods of time, it may cause leakage due to the material deterioration of age. In such a case, give an additional tightening to the tube connection part. If leakage still occurs after giving an additional tightening, replace the fitting with a new product. For other precautions, refer to "Fittings & Tubing Precautions" in Best Pneumatics No. 7. When using the fluoropolymer fittings, refer to the precautions on pages 944 and 945. Select the size after confirming O.D. and I.D.

Note 3) TIHA01, TIHC01, TIHA05, TIHA07 and TIHA11 are not available because of different internal diameters.

Note 4) The minimum bending radius is the representative value measured as shown in the left figure.

- Use a tube above the recommended minimum bending radius.
- The tubing may be bent if used under the recommended minimum bending radius. Therefore, refer to the tube close bend radius and make sure that the tubing is not bent or flattened.
- Please note that the tube close bend radius is not warranted because of the value when 2R is measured by the method in the left figure if the tubing is bent or flattened, etc.

How to Order

Inch size

TIHA01 N - 16

Indication of tubing model • Color indication • Length per roll

Symbol	Color
N	Translucent (Material color)
R	Red (Translucent)
BU	Blue (Translucent)
B	Black (Opaque)

Symbol	Roll size
16	16 m (50 ft) roll
33 ^{Note)}	33 m (100 ft) roll

Note) 33 m (100 ft) roll is available with translucent (color indication: N) only.

Related Products

Tube Cutter: TK-5

As this product is made of stainless steel it can be used inside clean rooms.

* However, this product is packaged regularly, not in double packaging.

Safety lock contained



Note) The blade can be easily replaced with a Phillips head screwdriver.
Please refrain from touching the blade tip during replacement. Failure to do so may result in injury.
Be aware that when loosening the mounting screws, the blade may fall out, causing injury.

Model	TK-5
Applicable tubing material	Fluoropolymer, Polyolefin, and other soft plastic tubing
Applicable tubing O.D.	25 mm or less
Weight	100 g
Replacement blade part no.	TK-DPM00132 (5 replacement blades)

How to Replace the TK-5 Blade

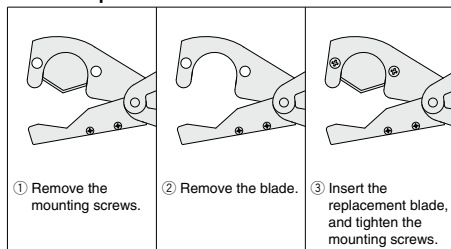

LVC

LVA

LVH

LVD

LVQ

LVP

LVW

LQ1

LQ3

LVN

LQHB

TL

TIL

TLM

TILM

TD

TID

TH

TIH



TL/TIL/TD/TID Series

Applicable Fluid List

Chemical resistance of Fluoropolymer Super PFA, modified PTFE material

Chemicals in the list below are chemically inert ^{Note 1)} to Super PFA, modified PTFE material. Possible physical effects may occur such as penetration and swelling due to temperature, pressure and chemical concentration. To use Super PFA, modified PTFE tube in a chemical environment, tests should be performed with the same environment to ensure no problem occurs with operating environment.

1,1,1-Trichloroethane	Formic acid	Trichloroethylene
1,1,2-Trichloroethane	Ethyl formate	Trichloroacetic acid
1,2,3-Trichloropropane	Propyl formate	Toluene
1,2-Dichlorobutane	Methyl formate	Naphtha
2,4-Dichlorotoluene	Xylene	Carbon dioxide
2-chloropropane	Glycol	Nitrogen dioxide
2-nitro-2-methylpropane	Glycerine	Nitrobenzene
2-nitrobutanol	Cresol	Nitromethane
Pentabasic benzamide	Chromic acid	Carbon disulfide
Hydrochlorofluorocarbon-22	Chloroacetic acid	Piperidine
N-octadecanol	Chlorosulfonic acid	Pyridine
N-butylamine	Chloroform	Pyrogallol
o-chlorotoluene	Paraffinum liquidum	Phenol
Isobutyl adipate	Acetate	Butanol
Acetyl chloride	Amyl acetate	Phthalic acid
Acetophenone	Ethyl acetate	Hydrofluoric acid
Acetone	Potassium	Furan
Aniline	Butyl acetate	Ethyl propionate
Sulfurous acid gas	Propyl acetate	Propyl propionate
Allyl chloride	Methyl acetate	Methylpropionate
Benzoic acid	Salicylic acid	Propylene chloride
Ammonium	Sodium hypochlorite	Bromobenzene
Sulfur	Diisobutyl ketone	Hexachlorethane
Isoamyl alcohol	Diethylamine	Hexane
Isooctane	Carbon tetrachloride	Heptane
Ethanol	Dioxane	Benzyl alcohol
Ethyl ether	Cyclohexanone	Benzaldehyde
Ethylene glycol	Cyclohexane	Benzene
Ethylene chloride	Dichloroethylene	Benzoyl chloride
Ethylendiamine	Dichloropropylene	Benzonitrile
Zinc chloride	Dibutyl phthalate	Pentachloroethane
Aluminum chloride	Dimethyl ether	Boric acid
Ammonium chloride	Dimethylsulfoxide	Sodium boric acid
Calcium chloride	Dimethylformamide	Formaldehyde
Ferrous chloride	Hydrobromic acid	Acetic anhydride
Mercuric chloride	Potassium dichromate	Methanol
Stannous chloride	Bromine	Methyl ether
Ferric chloride	DI water (Pure water)	Methyl ethyl ketone
Cupric chloride	Nitric acid	Methylene chloride
Sodium chloride	Ammonium hydroxide	Ethyl butyrate
Magnesium chloride	Potassium hydroxide	Methyl butyrate
Hydrochloric acid	Sodium hydroxide	Hydrogen sulfide
Chlorine	Soap, detergent	Sulphuric acid
Aqua regia	Diethyl carbonate	Zinc sulfate
Ozone	Sodium carbonate	Ammonium sulfate
Oleic acid	Tetrachloroethane	Ferrous sulfate
Perchlorate	Tetrachloroethylene	Copper sulfate
Hydrogen peroxide	Tetrahydrofuran	Phosphoric acid
Natrium peroxide	Tetrabromoethane	Sodium phosphate
Gasoline	Triethanolamine	
Potassium permanganate	Triethylamine	

Note 1) "Chemically inert" means – not to cause any chemical reaction.

Note 2) The data above is based on the information presented by the material manufacturers.

Note 3) The applicable fluid list provides reference values as a guide only, therefore we do not guarantee the application to our product.

Note 4) SMC is not responsible for its accuracy and any damage happened because of this data.

LVC

LVA

LVH

LVD

LVQ

LVP

LVW

LQ1

LQ3

LVN

LQHB

TL

TIL

TLM

TILM

TD

TID

TH

TIH



TLM/TILM Series

Applicable Fluid List

Chemical resistance of Fluoropolymer PFA material

Chemicals in the list below are chemically inert^(Note), to PFA material. Possible physical effects may occur such as penetration and swelling due to temperature, pressure and chemical concentration.

To use PFA tube in a chemical environment, tests should be performed with the same environment to ensure no problem occurs with operating environment.

Acetate	Butyl stearate	Ethylene dichloride	Malic acid	Salicylic acid
Acetic anhydride	Calcium acetate	Ethylene glycol	Mercaptan	Silicate ester
Acetone	Calcium bisulfite	Ethylene oxide	Mercuric chloride	Silicone grease
Acetylene	Calcium chloride	Ethylenediamine	Mercury	Silicone oil
Acrylonitrile	Calcium hydroxide	Fatty acid	Methyl acetate	Silver nitrate
Aluminum acetate	Calcium hypochlorite	Ferric chloride	Methyl alcohol	Sodium bicarbonate
Aluminum nitrate	Calcium nitrate	Ferric nitrate	Methyl chloride	Sodium bisulfate
Aluminum bromide	Calcium sulfide	Ferric sulfate	Methyl ethyl ketone	Sodium bisulfite
Aluminum chloride	Carbon dioxide	Fluoroboric acid	Methyl isobutyl ketone	Sodium hypochlorite (5%)
Aluminum fluoride	Carbon disulfide	Fluorobenzene	Methyl methacrylate	Sodium metaphosphate
Aluminum sulfate	Carbonic acid	Fluorilic acid	Methylene dichloride	Sodium nitrate
Ammonia gas	Castor oil	Formaldehyde	Mineral oil	Sodium perborate
Ammonium carbonate	Caustic soda (30%)	Formic acid	Monochloroacetic acid	Sodium phosphate
Ammonium chloride	Cellosolve	Furfural	Monochlorobenzene	Sodium sulfite
Ammonium hydroxide	Chlorosulfonic acid	Gasoline	Monoethanolamine	Sodium thiosulfate
Ammonium nitrate	Chlorotoluene	Gelatine	Naphtha	Soybean oil
Ammonium nitrite	Chromic acid	Glauber's salt	Naphthalene	Stannic chloride
Ammonium persulfate	Citric acid	Glucose	Naphthenic acid	Stearic acid
Ammonium phosphate	Coconut oil	Glue	Sodium peroxide	Styrene
Ammonium sulfate	Copper cyanide	Glycerine	Natural gas	Sucrose solution
Amyl acetate	Copper sulfate	Grease	Nickel acetate	Sulfur
Amyl alcohol	Corn oil	Hexaldehyde	Nickel chloride	Sulfur chloride
Amyl borate	Cottonseed oil	Hexane	Nickel sulfate	Sulfuric acid (98%)
Amyl naphthalene	Creosote oil	Hexyl alcohol	Nitric acid (60%)	Sulfurous acid gas
Aniline	Cresol	Hydrobromic acid	Nitrobenzene	Tannic acid
Aniline dye	Cupric chloride	Hydrochloric acid	Nitroethane	Tartaric acid
Animal oil (Lard oil)	Cyclohexane	Hydrocyanic acid	Nitromethane	Terpineol
Aqua regia	Cyclohexanol	Hydrofluoric acid (49%)	Nitropropane	Tetrachloroethane
Arsenic acid	Cyclohexanone (Anon)	Hydrofluoric acid anhydrous	Octyl alcohol	Tetraethyl lead
Asphalt	Dibutyl phthalate	Hydrogen peroxide (30%)	Oxalic acid	Tetrahydrofuran
Barium chloride	Dichlorobenzene	Hydrogen sulfide	Oxygen	Tetralin
Barium hydroxide	Diethyl sebacate	Hydroquinone	Ozone	Thionyl chloride
Barium sulfate	Diethylene glycol	Hypochlorous acid	Palmitic acid	Triacetin
Barium sulfide	Diisopropyl keton	Isobutyl alcohol	Perchlorate	Tributoxy ethyl phosphate
Beer	Diocetyl phthalate	Isooctane	Perchloroethylene	Tributyl phosphate
Beet sugar liquors	Diocetyl sebacate	Isopropyl acetate	Petroleum	Trichloroethylene
Benzaldehyde	Dipentene (Limonene)	Isopropyl alcohol	Phenol	Tricresyl phosphate
Benzene	Diphenyl	Isopropyl ether	Phosphoric acid (75%)	Triethanolamine
Benzene (Benzol)	Diphenyl oxide	Kerosene	Picric acid	Tung oil
Benzyl alcohol	Epichlorohydrin	Lead acetate	Piperidine	Turpentine oil
Benzyl benzoate	Ethanolamine	Lead nitrate	Potassium chloride	Vegetable oil
Benzyl chloride	Ethyl acetate	Lead sulfamate	Potassium dichromate	Vinegar
Borax	Ethyl acetoacetate	Linolenic acid	Potassium hydroxide	Water
Boric acid	Ethyl acrylate	Linseed oil	Potassium nitrate	Whiskey
Bromine	Ethyl alcohol	Liquid ammonia	Potassium permanganate	Xylene
Bunker oil	Ethyl benzene	LPG (Liquefied petroleum gas)	Potassium sulfate	Zeolite
Butane	Ethyl cellulose	Lubricating oil	Propyl acetate	Zinc acetate
Butter	Ethyl chloride	Magnesium chloride	Propyl alcohol	Zinc chloride
Butyl acetate	Ethyl oxalate	Magnesium hydroxide	Propylene	Zinc sulfide
Butyl acrylate	Ethyl silicate	Magnesium sulfate	Pyridine	
Butyl alcohol (Butanol)	Ethylene chlorohydrin	Maleic acid	Pyrrrole	

Note) "Chemically inert" means – not to cause any chemical reaction.



TH/TIH Series

Applicable Fluid List

Chemical Resistance of Fluoropolymer FEP Material

Chemicals in the list below are chemically inert ^{Note)} to FEP material, however physical properties may be effected by temperature or pressure change.
 Please make sure that operating conditions do not cause problems since the use of FEP tubing under chemical environment is unsecured.

2-nitro-2-methyl propanol	Chloroform	Nitromethane
2-nitrobutanol	Paraffinum liquidum	Perchloroethylene
Pentabasic benzamide	Allyl acetate	Perphloroxylene
N-butylamine	Ethyl acetate	Unsymmetrical dimethylhydrazine
N-octadecanol	Potassium	Hydrazine
N-butyl acetate	Butyl acetate	Pinene
O-cresol	Sodium hypochlorite	Piperidine
Di-isobutyl adipate	Carbon tetrachloride	Glacial acetic acid (Acetic acid)
Acetophenone	Dioxane	Pyridine
Acetone	Cyclohexanone	Phenol
Aniline	Cyclohexane	Phthalic acid
Abietic acid	Dimethyl ether	Dybutyl phthalate
Sulfuric chloride	Dimethylsulfoxide	Dimethyl phthalate
Isooctane	Dimethylformamide	Hydrofluoric acid
Liquid ammonia	Bromine	Naphthalene fluoride
Ethyl alcohol	DI water (Pure water)	Nitrobenzene fluoride
Ethyl ether	Nitric acid	Furan
Ethylene glycol	Mercury	Hexachlorethane
Ethylenediamine	Ammonium hydroxide	Hexane
Zinc chloride	Potassium hydroxide	Ethyl hexanoate
Aluminum chloride	Sodium hydroxide	Phenylcarbinol
Ammonium chloride	Cetane	Benzaldehyde
Calcium chloride	Soap, detergent	Benzonitrile
Sulfuric chloride	Dibutyl sebacate	Borax
Iron chloride (III)	Diethyl carbonate	Boric acid
Benzoyl chloride	Tetrachloroethylene	Formic aldehyde (Formalin)
Magnesium chloride	Tetrahydrofuran	Acrylic anhydride
Hydrochloric acid	Tetrabromoethane	Acetic anhydride
Chlorine (absolute)	Triethanolamine	Methacrylic acid
Aqua regia	Trichloroethylene	Allyl methacrylate
Ozone	Trichloroacetic acid	Vinyl methacrylate
Hydrogen peroxide	Toluene	Methyl alcohol
Natrium peroxide	Naphtha	Methyl ethyl ketone
Gasoline	Naphthalene	Methylene chloride
Permanganate	Naphthol	Sulphuric acid
Formic acid	Lead	Phosphoric acid
Xylene	Carbon dioxide	Iron phosphate (III)
Chromic acid	Nitrogen dioxide	Tri-n-butyl phosphate
Chlorosulfonic acid	Nitrobenzene	Tricresyl phosphate

Note) "Chemically inert" means – not to cause any chemical reaction.

Reference cited: Teflon®, the fluoropolymer handbook, Manual for the chemical applications of Teflon®. Du Pont-Mitsui Fluorochemicals Co., Ltd.

Teflon® is a registered trademark for the fluoropolymer produced by E.I du Pont de Nemours & Company (Inc.) and Du Pont-Mitsui Fluorochemicals Co., Ltd.

LVC
LVA
LVH
LVD
LVQ
LVP
LVW
LQ1
LQ3
LVN
LQHB
TL
TIL
TLM
TILM
TD
TID
TH
TIH



TL/TIL/TLM/TILM/TD/TID/TH/TH Series Tubing/Precautions

Be sure to read this before handling the products.

Selection

⚠ Warning

1. Confirm the specifications.

Products represented in this catalog are designed only for use in compressed air systems (including vacuum). Do not operate at pressures or temperatures, etc., beyond the range of specifications, as this can cause damage or malfunction. (Refer to the specifications.)

2. In case of using the product for medical care

This product is designed for use with compressed air system applications for medical care purposes. Do not use in contact with human bodily fluids, body tissues or transfer applications to a human living body.

⚠ Caution

1. Do not use in locations where the connecting threads and tubing connection will slide or rotate.

The connecting threads and tubing connection will come apart under these conditions.

2. Use tubing at or above the minimum bending radius. Using below the minimum bending radius can cause breakage or flattening of the tubing.

3. Never use the tubing for anything flammable, explosive or toxic such as gas, fuel gas, or cooling mediums etc.

Because the contents may penetrate outward.

4. Use the fittings applicable to the tubing size.

Mounting

⚠ Caution

1. Confirm model no., size, etc. before installing.

Check tubing for damage, gouges, cracks, etc.

The fluoropolymer tubing do not have the model number displayed on the product due to the resin material used. If tubing without a model label is mixed with other tubing which also does not have a model label, it is impossible to identify the model. Please avoid mixing the products with other models while it is being used and/or stored.

2. When tubing is connected, consider factors such as changes in the tubing length due to pressure, and allow sufficient leeway.

3. Do not apply unnecessary forces such as twisting, pulling, moment loads, etc. on fittings or tubing.

This will cause damage to fittings and will crush, burst or release tubing.

4. Mount so that tubing is not damaged due to tangling and abrasion.

This can cause flattening, bursting or disconnection of tubing, etc.

Piping

⚠ Caution

1. Preparation before piping

Before piping is connected, it should be thoroughly blown out with air (flushing) or washed to remove chips, cutting oil and other debris from inside the pipe. Not allowing chips of the piping thread or the seal material to go in.

Air Supply

⚠ Warning

1. Types of fluid

This product is designed for use with compressed air.

2. In case of excessive condensation

Excessive condensation in a compressed air system may cause pneumatic equipment to malfunction. Installation of an air dryer, water separator before filter is recommended.

3. Drain flushing

If condensation in the drain bowl is not emptied on a regular basis, the bowl will overflow and allow the condensation to enter the compressed air lines. It causes malfunction of pneumatic devices.

If the drain bowl is difficult to check and remove, installation of a drain bowl with an auto drain option is recommended.

For compressed air quality, refer to SMC's "Air Cleaning Equipment" catalog.

Operating Environment

⚠ Warning

1. Do not use in locations having an explosive atmosphere.

2. Do not operate in locations where vibration or impact occurs.

3. In locations near heat sources, block off radiated heat.

Maintenance

⚠ Caution

1. Reform periodic inspections to check the following problems and replace tubing, if necessary.

- 1) Cracks, gouges, wearing, corrosion
- 2) Air leakage
- 3) Twists or crushing of tubing
- 4) Hardening, deterioration, softening of tubing

2. Do not repair or patch the replaced tubing or fittings for reuse.

3. When using insert or miniature fittings over a long period, some leakage may occur due to age deterioration of the materials. If any leakage is detected, correct the problem by additional tightening.

If tightening becomes ineffective, replace the fittings with a new product immediately.