

# Fieldbus System (128 Points)

## EX500 Series

The EX500 series is to be discontinued. When designing new equipment and facilities, consider using another series (EX260/EX600) instead.

### Decentralized valve installation

Valves can be installed near the actuators!



\* Only the SY and SV valves are UL-compliant.

GW unit (Gateway unit)



Reduced piping space and piping materials

Reduced wiring space

No need to set the address for the valve manifolds and input units

Description	Compatible protocol	Number of inputs/outputs	Number of valve manifold and input unit connections	Branch cable length	New function
Gateway Decentralized System 2 Page 1448	 EtherNet/IP	128 inputs/ 128 outputs	Max. 16 units	Max. 20 m	<b>Web server function</b> • Valve operation test • Connection diagnostic • Short-circuit diagnostic Page 1443

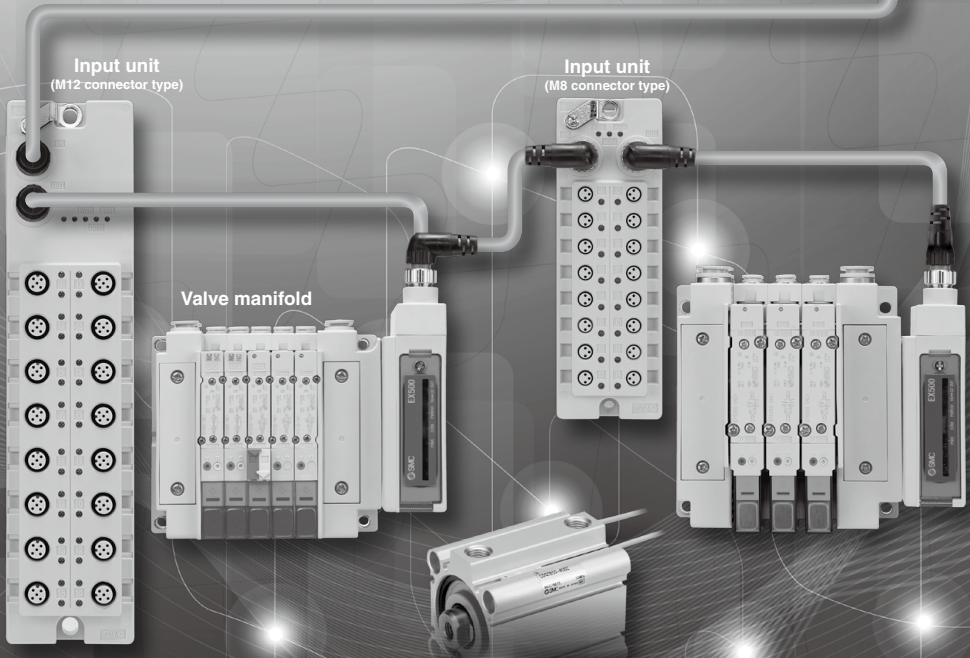

## Gateway Decentralized System 2 (128 Points)

● Number of branch ports: 4

Number of inputs/outputs **128** inputs/**128** outputs

● Number of inputs/outputs per branch: Max. 32 inputs/32 outputs

Number of valve manifold connections **Max. 8 units**\*1 Number of input unit connections **Max. 8 units**

● Number of valve manifold connections per branch: Max. 2 units\*1 ● Number of input unit connections per branch: Max. 2 units

Total cable length per branch **Max. 20 m**

\*1 When the number of outputs is set to "16 outputs" using the built-in setting switch of the SI unit

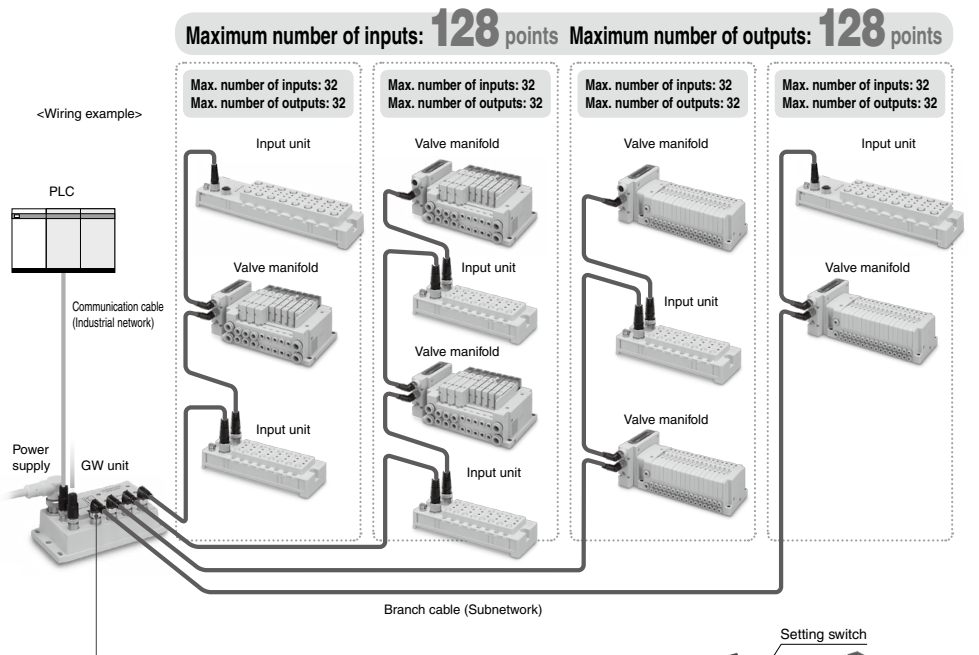

### Two valve manifolds can be connected to one branch port.

The SI unit has a built-in setting switch which switches the number of outputs (32 points/16 points) of the valve manifold connected to the SI unit. By setting the number of outputs to 16 points, two valve manifolds can be installed to one branch port.

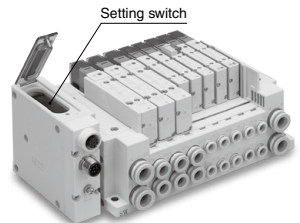

SI unit



## Web server function

A valve operation test (ON/OFF), a connection diagnostic between the valve manifolds and the input units, and a short-circuit diagnostic of input devices can be performed on a web browser.

A password can be used for the valve operation test (ON/OFF) for security.

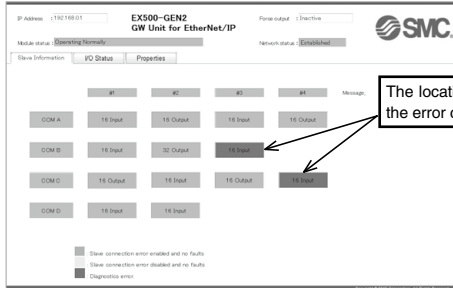

\* Web display example

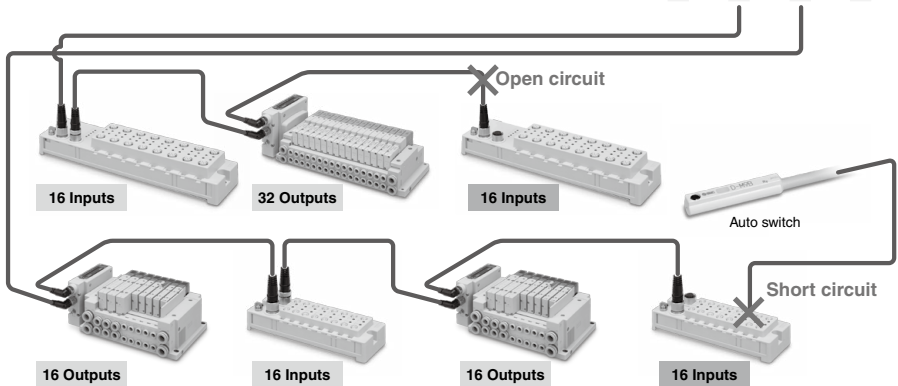
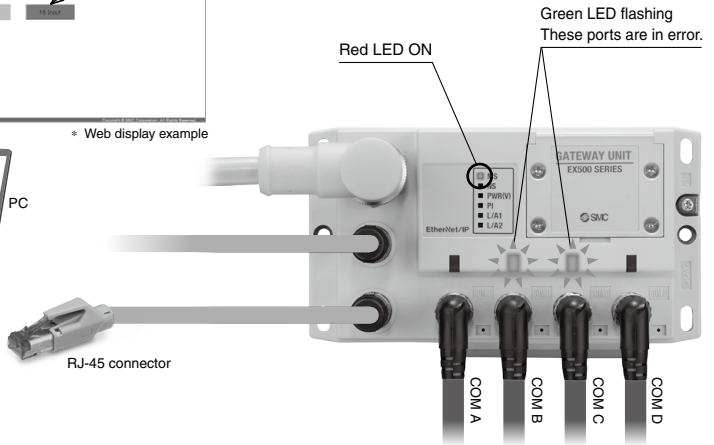

## No need to set the address

I/O mapping for the SI unit and input unit is set by the gateway unit automatically.

The unit installation order is not specified.

(The upper limit of the inputs/outputs is 32 points for one branch port.)

# Gateway Decentralized System 2 (128 Points)

## Reduced wiring

The amount of communication and power supply wiring for the I/O device can be reduced.

## Reduction in number of communication nodes

By reducing the number of communication nodes, the load on the network is reduced.

## Accessories can be ordered together.

Page 1454 Page 1472

Accessories including cables and connectors can be ordered together from SMC. Parts selection and ordering times as well as delivery management can be reduced.



## Flexibly copes with changes in the protocol

Previously, it was necessary to change the part number of the I/O unit, return the I/O unit, and make arrangements once again to obtain a new unit (additional quotation, delivery management).



Now, only the GW unit needs to be changed.

## Applicable to output devices other than valve manifolds

Page 1459

By using an output block, lights and buzzers can be operated.

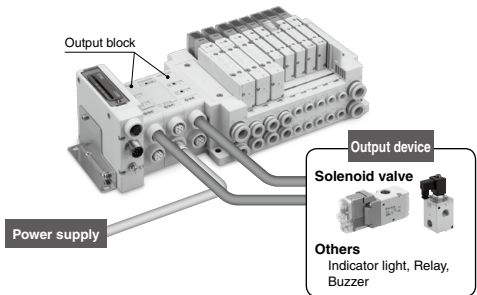

## Specified valve manifolds can be controlled by supplying power from a different system.

Page 1457

By using a Y branch connector, power from a different system can be supplied to the SI unit (valve manifold).

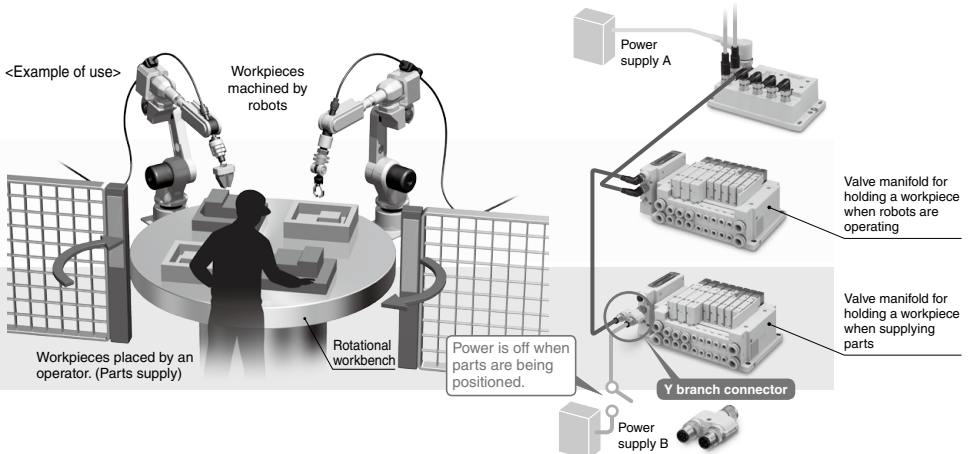

















## System Comparison Table

Gateway Decentralized System 2	
Protocol	 EtherNet/IP
Number of inputs/outputs (Number of inputs/outputs per branch)	<b>128 inputs/128 outputs</b> <b>(32 inputs/32 outputs)</b>
Number of valve manifold connections (Number of connections per branch)	<b>Max. 8 units*<sup>1</sup></b> <b>(Max. 2 units)</b>
Number of input unit connections (Number of connections per branch)	<b>Max. 8 units</b> <b>(Max. 2 units)</b>
Branch cable length	<b>Max. 20 m</b>
Enclosure	GW unit: IP65 SI unit: IP67 Input unit: IP67
Function	Web server function (Valve operation test, Connection diagnostic, Short-circuit diagnostic)
Page	1448

\*1 When the number of outputs is set to "16 outputs" using the built-in setting switch of the SI unit

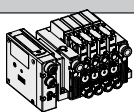
## Applicable Valve/Vacuum Unit

Applicable valve	Flow rate characteristics (4/2--5/3)		Maximum number of solenoids	Power consumption [W]	Enclosure	Standards	Page
	C [dm <sup>3</sup> /(s·bar)]	b					
	SY3000	1.6	0.19	32	0.35 (Standard) 0.1 (With power-saving circuit) [Inrush 0.4, Holding 0.1]		
	SY5000	3.6	0.17				
	SY7000	5.9	0.20				
	VQC1000	1.0* <sup>1</sup>	0.30* <sup>1</sup>	24	0.4 (Standard)  0.95 (Standard) 0.4 (Low-wattage type)		
	VQC2000	3.2* <sup>1</sup>	0.30* <sup>1</sup>				
	VQC4000	7.3* <sup>1</sup>	0.38* <sup>1</sup>				
	VQC5000	17.0* <sup>1</sup>	0.31* <sup>1</sup>				
	S0700	0.37	0.39	32	0.35		
	SV1000	1.1	0.35	32	0.6		
	SV2000	2.4	0.18				
	SV3000	4.3	0.21				
Applicable vacuum unit	Nozzle diameter [mm]		Max. number of solenoids	Power consumption [W]	Enclosure	Standards	Page
	ZK2□A	0.7	16	0.4			Web Catalog
		1.0					
		1.2					
		1.5					

\*1 Values for 2-position single, rubber seal type

# SY3000/5000/7000 Series

Piping on the top or the bottom allows for a reduced footprint and increased space saving.

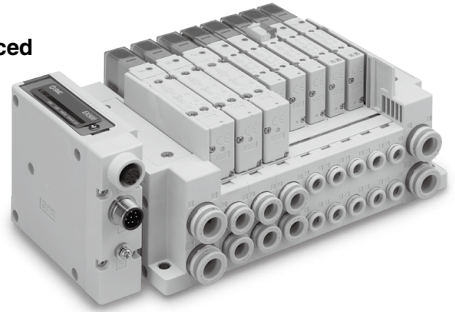

## Valve piping direction variations

■ Piping is possible from 3 directions.

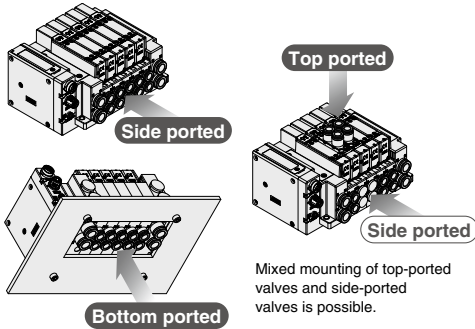

## Max. 24 stations are connectable.

■ It is possible to connect only the number of valves required, from 1 to 24 stations, to suit the application. (Maximum number of solenoids: 32)

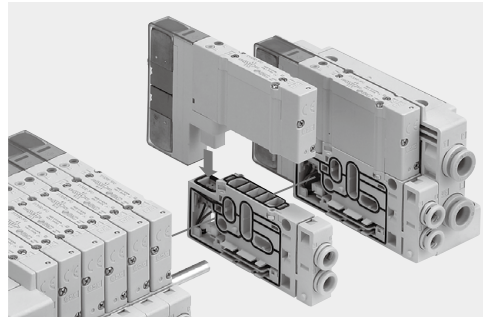

## Mixed valve sizes manifold

It is also possible to install a combination of different-sized valves on the same manifold. (SY3000 and SY5000, or SY5000 and SY7000)

This facilitates a reduction in the installation space and number of units/cables.

■ Example: For the SY5000 and SY3000

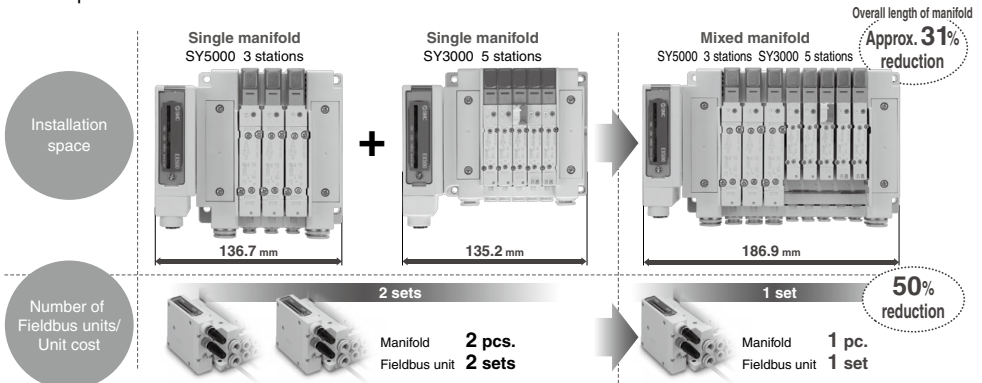

# CONTENTS

## Type 2 Gateway type

### Fieldbus System (128 Points)

### *EX500 Series*

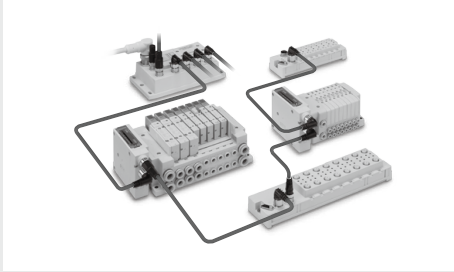

### Gateway Decentralized System 2 (128 Points) ... p. 1448

#### GW Unit

How to Order .....	p. 1449
Specifications .....	p. 1449
Dimensions/Parts Description .....	p. 1450

#### SI Unit

How to Order .....	p. 1451
Specifications .....	p. 1451
Dimensions/Parts Description .....	p. 1451

#### Input Unit

How to Order .....	p. 1452
Specifications .....	p. 1452
Dimensions/Parts Description .....	p. 1452

#### LED Indicator ..... p. 1453

#### Accessories

① Power Supply Cable .....	p. 1454
② Communication Cable .....	p. 1455
③ Field-wireable Communication Connector .....	p. 1456
④ Branch Cable .....	p. 1457
⑤ Y Branch Connector .....	p. 1457
⑥ Cable for Power Supply from a Different System ...	p. 1458
⑦ DIN Rail Bracket (2 pcs.) .....	p. 1458
⑧ Marker (1 sheet, 88 pcs.) .....	p. 1458
⑨ Seal Cap (10 pcs.) .....	p. 1458
⑩ Output Block .....	p. 1459
⑪ Power Block .....	p. 1459
⑫ Power Supply Cable (For power block) .....	p. 1460
⑬ Connector for Output Block Wiring .....	p. 1461
⑭ End Plate .....	p. 1461
⑮ Bracket Plate/DIN Rail Mounting Bracket .....	p. 1461

#### Made to Order

Power Supply Cable .....	p. 1475
Specific Product Precautions .....	p. 1476

# Fieldbus System Gateway Decentralized System 2 (128 Points)

## EX500 Series



- ★ Valve manifolds and input units can be connected around the GW (Gateway) unit.
- ★ Compatible with other protocols by replacing the GW unit
- ★ Number of inputs/outputs = 128 points/128 points  
The number of outputs (solenoids) per branch is 32 points.
- ★ Number of valve manifold connections = Max. 8 units, Number of input unit connections = Max. 8 units, Branch cable length = Max. 20 m
- ★ Web server function (Valve operation test, Connection diagnostic of units, Short-circuit diagnostic of input devices)
- ★ No need to set the address for the valve manifolds or input units

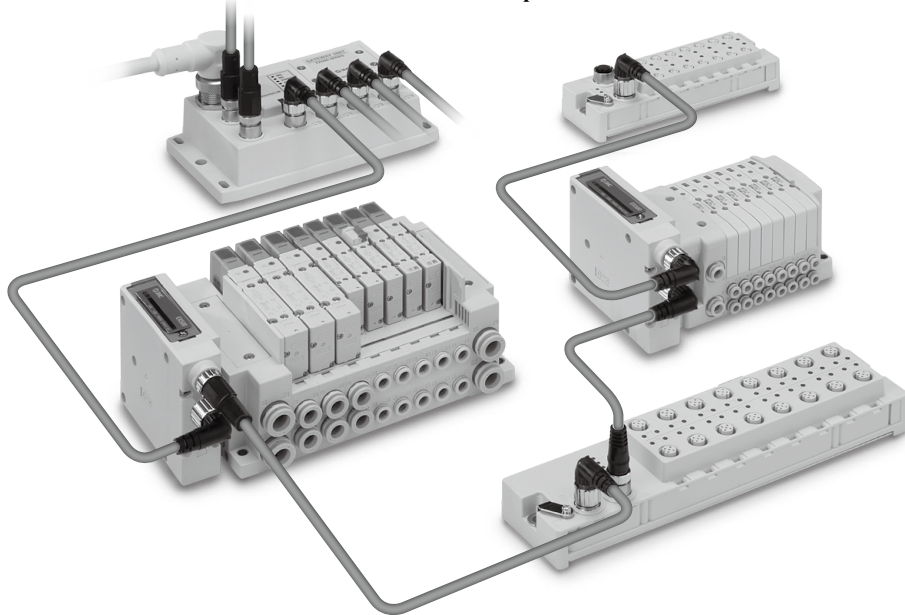

### Applicable Manifold

SY3000/5000/7000



VQC1000/2000/4000/5000



S0700



SV1000/2000/3000



### Applicable Vacuum Unit

ZK2□A



# Gateway Decentralized System 2 (128 Points) GW Unit



\* Only the SY and SV valves are UL-compliant.



## How to Order

### EX500 — G EN2

Protocol

EN2	EtherNet/IP™ (Input/Output = 128 points/128 points)
PN2	PROFINET (Input/Output = 128 points/128 points)



## Specifications

Model		EX500-GEN2	EX500-GPN2
Communication	Protocol	EtherNet/IP™*1	PROFINET IO
	Version*2	Volume 1 (Edition 3.14) Volume 2 (Edition 1.15)	PROFINET Specification Version 2.2
	Media	100BASE-TX	100BASE-TX
	Communication speed	10/100 Mbps (Automatic)	100 Mbps
	Communication method	Full duplex/Half duplex (Automatic)	Full duplex
	Number of inputs/ outputs (I/O occupation area)	128 inputs/128 outputs (20 bytes/20 bytes)	128 inputs/128 outputs (18 bytes/16 bytes)
	Configuration file*3	EDS file	GSDML
	IP address setting range	Switch settings: 192.168.0.1 to 254 or 192.168.1.1 to 254, Through DHCP server: Optional address	Optional address
	Device information	Vendor ID: 7 (SMC Corporation) Product type: 12 (Communication Adapter), Product code: 198	—
	Applicable function	DLR QuickConnect™ Web server	MRP Fast Start Up Web server
Power supply voltage	For input and control	24 VDC ±10%	
	For valve	24 VDC +10%, -5%	
Current consumption	For input and control	6.2 A or less (Max. 1.5 A per branch x 4 branches + GW unit internal current consumption: 0.2 A or less)	
	For output (valve)	4 A or less (Max. 1 A per branch x 4 branches)	
Branch port	Number of branch ports	4 ports	
	Number of inputs and outputs	32 inputs/32 outputs per branch	
	Branch cable length	20 m or less per branch	
Environmental resistance	Enclosure	IP65	
	Operating temperature range	Operating: -10 to +50°C, Stored: -20 to +60°C (No condensation)	
	Operating humidity range	Operating, Stored: 35 to 85%RH (No condensation)	
Standards	CE/UKCA marking, UL (CSA)		
Weight	550 g		
Enclosed parts	Seal cap (for M12 connector socket) 5 pcs.		

\*1 Use a CAT5 or higher communication cable.

\*2 Please note that the version is subject to change.

\*3 The setting file can be downloaded from SMC website, <https://www.smworld.com>



# EX500 Series

## Dimensions/Parts Description

### EX500-GEN2 (EtherNet/IP™)

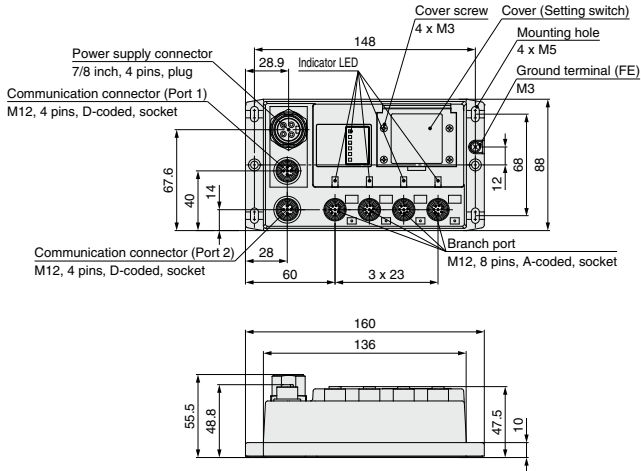

### EX500-GPN2 (PROFINET)

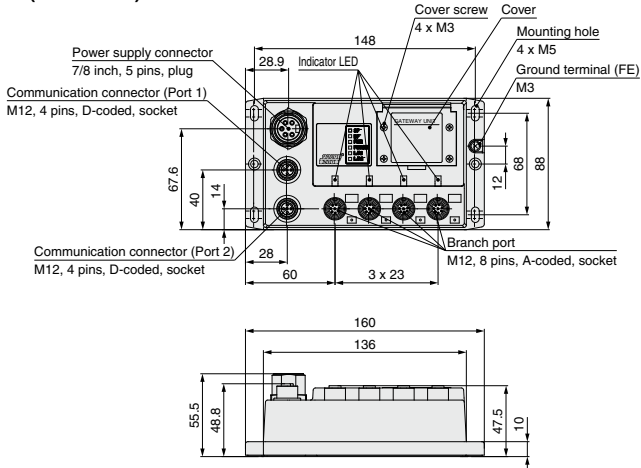

## SI Unit

Output unit for valve manifold connection



How to Order

EX500—S103



## Specifications

Model		EX500-S103
Applicable valve/Vacuum unit		SY, VQC, S0700, SV, ZK2□A
Output	Number of outputs	16/32 outputs (Switched by built-in setting switch)
	Output type	Source/PNP (Negative common)
	Rated voltage	24 VDC
	Supply current	With power supplied to GW unit: Max. 1.0 A With external power*1 supplied: Max. 1.5 A
Internal current consumption		50 mA or less
Environmental resistance	Enclosure	IP67
	Operating temperature range	Operating: -10 to +50°C, Stored: -20 to +60°C (No condensation)
	Operating humidity range	Operating, Stored: 35 to 85%RH (No condensation)
Standards		CE/UKCA marking, UL (CSA)
Weight		200 g
Enclosed parts		Seal cap (for M12 connector socket) 1 pc. Valve manifold mounting screw (M3 x 30) 2 pcs.

\*1 When an accessory, Y branch connector, is used.

## Dimensions/Parts Description

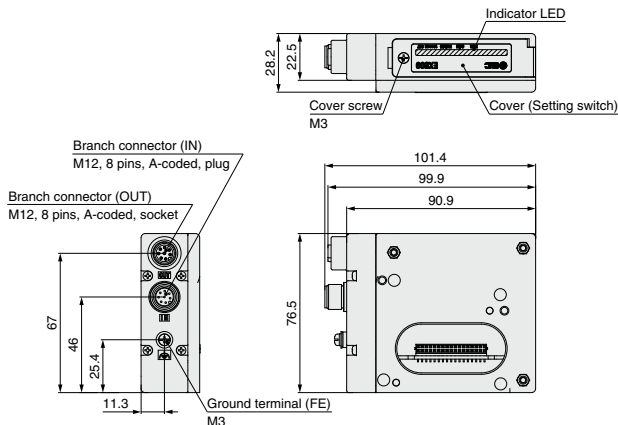

# Input Unit

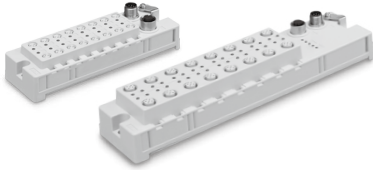

## How to Order

### EX500-DXPA

Input unit

Connector type

A	M8 connector type
B	M12 connector type

## Specifications

Model		EX500-DXPA	EX500-DXPB
Connector type		M8 connector	M12 connector
Input	Number of inputs	16 inputs	
	Input type	PNP sensor input	
	Rated voltage	24 VDC	
	Supply current	Max. 1.3 A/Unit [ Total of 8 connectors of even number must be Max. 0.65 A, 8 connectors of odd number must be Max. 0.65 A ]	
	Input ON voltage/Input ON current	11 V or more/Typ. 7 mA (at 24 VDC)	
	Input OFF voltage/Input OFF current	5 V or less/1.5 mA or less	
Internal current consumption		200 mA or less (when the input signal is ON)	
Environmental resistance	Enclosure	IP67	
	Operating temperature range	Operating: -10 to +50°C, Stored: -20 to +60°C (No condensation)	
	Operating humidity range	Operating, Stored: 35 to 85%RH (No condensation)	
Standards		CE/UKCA marking, UL (CSA)	
Weight		250 g	450 g
Enclosed parts		Seal cap (for M8 connector socket) 16 pcs.	Seal cap (for M12 connector) 17 pcs.
		Seal cap (for M12 connector socket) 1 pc.	

## Dimensions/Parts Description

### EX500-DXPA

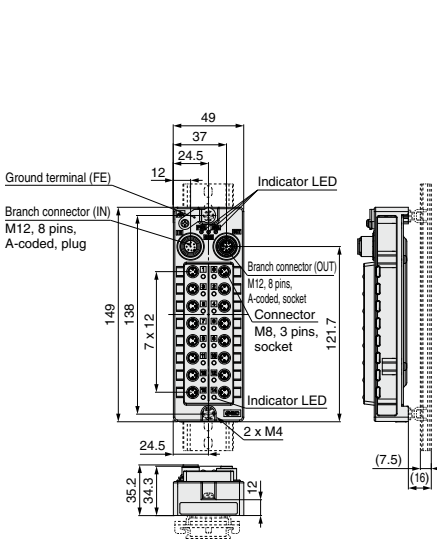

### EX500-DXPB

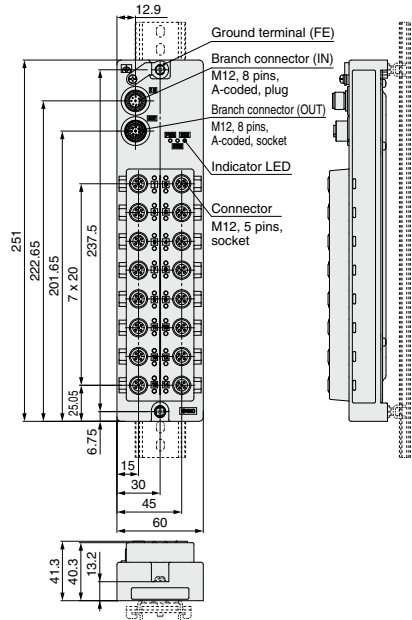

**LED Indicator**

**EX500-GEN2**

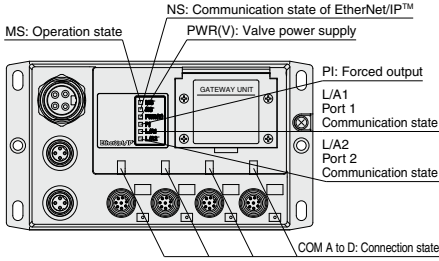

**EX500-GPN2**

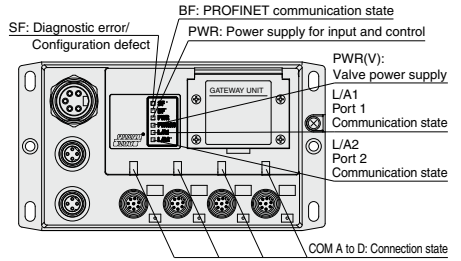

**EX500-S103**

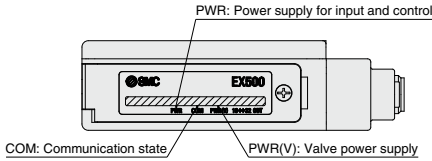

**EX500-DXPA**

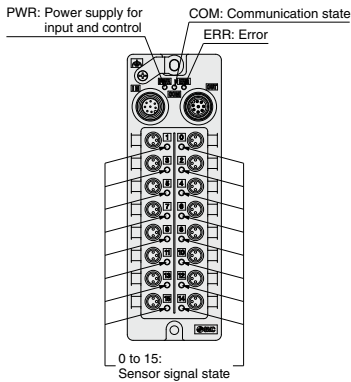

**EX500-DXPB**

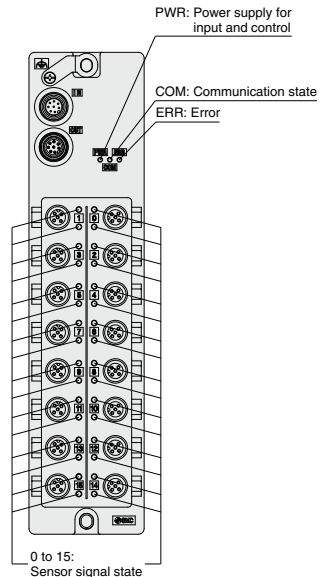

# Gateway Decentralized System 2 (128 Points) Accessories

## ① Power Supply Cable

Supplies power to the GW unit.

### For PROFINET

PCA-1558810

#### Connector specification, Cable length (L)

1558810	Straight 2 m
1558823	Straight 6 m
1558836	Angle 2 m
1558849	Angle 6 m

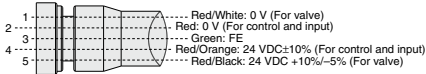
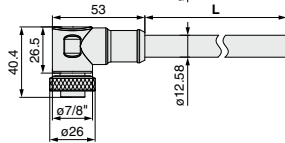
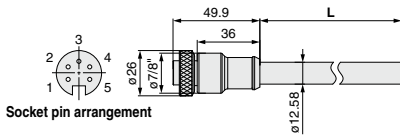

Item	Specifications
Cable O.D.	12.58 mm
Conductor nominal cross section	1.5 mm <sup>2</sup> /AWG16
Wire O.D. (Including insulator)	2.35 mm
Min. bending radius (Fixed)	110 mm

### For EtherNet/IP™

PCA-1416000

#### Connector specification, Cable length (L)

1415999	Straight 2 m
1415996	Straight 6 m
1416000	Angle 2 m
1415997	Angle 6 m

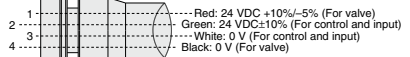
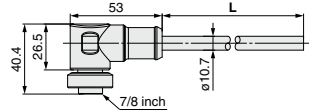
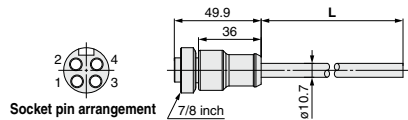

Item	Specifications
Cable O.D.	10.7 mm
Conductor nominal cross section	1.5 mm <sup>2</sup> /AWG16
Min. bending radius (Fixed)	94 mm



## ② Communication Cable

Connects field bus to the GW unit.

For PROFINET

For EtherNet/IP™

### EX9-AC 020 EN-PSRJ (Plug/RJ-45 connector)

● Cable length (L)

010	1000 mm
020	2000 mm
030	3000 mm
050	5000 mm
100	10000 mm

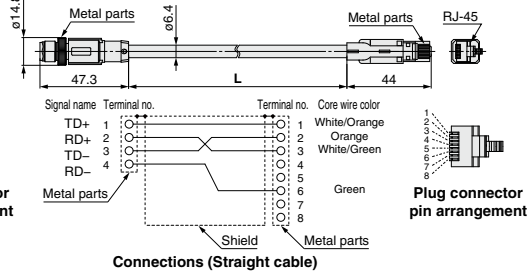
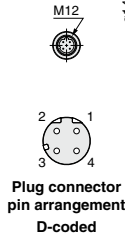

Item	Specifications
<b>Cable O.D.</b>	ø6.4 mm
<b>Conductor nominal cross section</b>	0.14 mm <sup>2</sup> /AWG20
<b>Wire O.D. (including insulator)</b>	0.98 mm
<b>Min. bending radius (Fixed)</b>	26 mm

### PCA-1446566 (Plug)

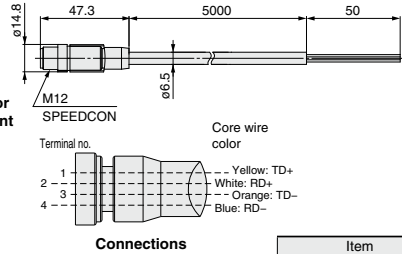
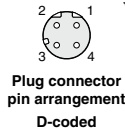

Item	Specifications
<b>Cable O.D.</b>	ø6.5 mm
<b>Conductor nominal cross section</b>	0.34 mm <sup>2</sup> /AWG22
<b>Wire O.D. (including insulator)</b>	1.55 mm
<b>Min. bending radius (Fixed)</b>	19.5 mm

### EX9-AC 005 EN-PSPS (With connector on both sides (Plug/Plug))

● Cable length (L)

005	500 mm
010	1000 mm
020	2000 mm
030	3000 mm
050	5000 mm
100	10000 mm

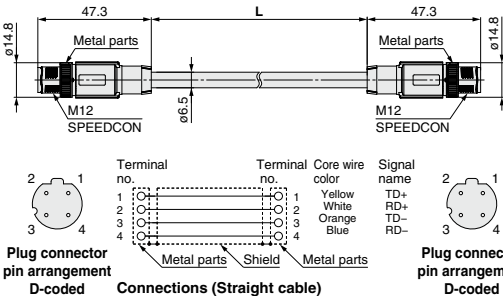

Item	Specifications
<b>Cable O.D.</b>	ø6.5 mm
<b>Conductor nominal cross section</b>	0.34 mm <sup>2</sup> /AWG22
<b>Wire O.D. (including insulator)</b>	1.55 mm
<b>Min. bending radius (Fixed)</b>	19.5 mm

# EX500 Series

## ② Communication Cable

For PROFINET For EtherNet/IP™

EX9-AC 005 EN-PAPA (With angle connector on both sides (Plug/Plug))

● Cable length (L)

005	500 mm
010	1000 mm
020	2000 mm
030	3000 mm
050	5000 mm
100	10000 mm

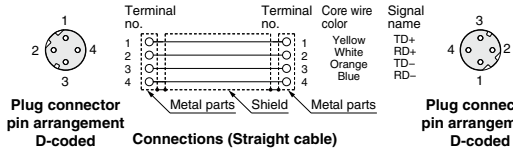
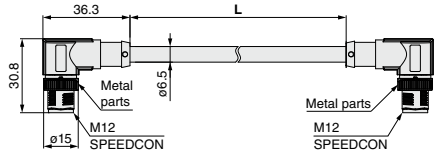

Plug connector pin arrangement D-coded

Connections (Straight cable)

Plug connector pin arrangement D-coded

Item	Specifications
Cable O.D.	ø6.5 mm
Conductor nominal cross section	0.34 mm <sup>2</sup> /AWG22
Wire O.D.(including insulator)	1.55 mm
Min. bending radius (Fixed)	19.5 mm

## ③ Field-wireable Communication Connector

For PROFINET For EtherNet/IP™

PCA-1446553

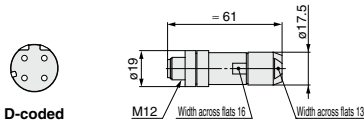

### Applicable Cable

Item	Specifications
Cable O.D.	4.0 to 8.0 mm
Wire gauge (Stranded wire cross section)	0.14 to 0.34 mm <sup>2</sup> /AWG26 to 22

\* The table above shows the specifications for the applicable cable. Adaptation for the connector may vary on account of the conductor construction of the electric wire.

#### 4 Branch Cable

Connects the GW unit and SI unit or input unit.

#### EX500-AC 030 - SSPS

##### Cable length (L)

003	300 mm
005	500 mm
010	1000 mm
030	3000 mm
050	5000 mm
100	10000 mm

##### Connector specification

SSPS	Socket side: Straight, Plug side: Straight
SAPA	Socket side: Angle, Plug side: Angle

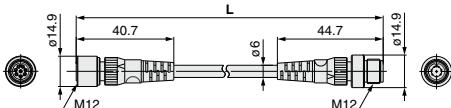

##### A-coded



Socket pin arrangement

##### A-coded



Plug pin arrangement

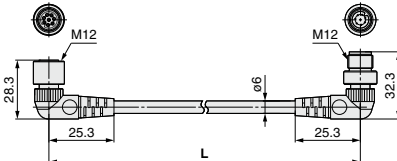

##### A-coded



Socket pin arrangement

##### A-coded



Plug pin arrangement

Item	Specifications
Cable O.D.	ø6 mm
Conductor nominal cross section	0.25 mm <sup>2</sup>
Wire O.D. (Including insulator)	1.27 mm
Min. bending radius (Fixed)	40 mm

#### 5 Y Branch Connector

Supplies separate power to valve manifold when it is connected to the SI unit.

#### EX500-ACY01-S

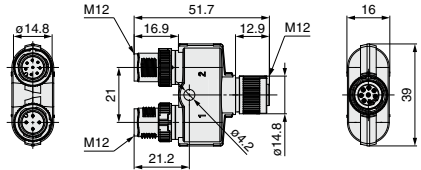

##### A-coded



Plug pin arrangement

##### Pin Layout of the Cable for Power Supply from a Different System

1	24 VDC +10%, -5% (for valve)
2	0 VDC (for valve)
3	Unused
4	Unused

#### <Example of use>

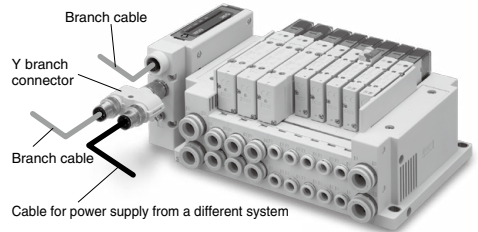

# EX500 Series

## ⑥ Cable for Power Supply from a Different System

Connect to Y branch connector to supply power.

### EX500-AP 050 - S

Cable length (L)

010	1000 mm
050	5000 mm

Connector specification

S	Straight
A	Angle

#### Straight connector type

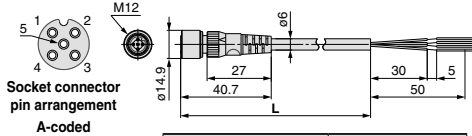

Item	Specifications
Cable O.D.	ø6 mm
Conductor nominal cross section	0.3 mm <sup>2</sup> /AWG22
Wire O.D. (Including insulator)	1.5 mm
Min. bending radius (Fixed)	40 mm

#### Angle connector type

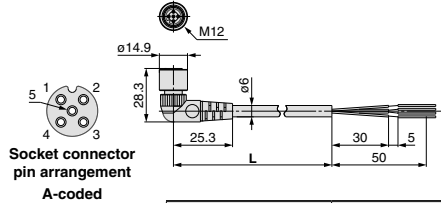

Item	Specifications
Cable O.D.	ø6 mm
Conductor nominal cross section	0.3 mm <sup>2</sup> /AWG22
Wire O.D. (Including insulator)	1.5 mm
Min. bending radius (Fixed)	40 mm

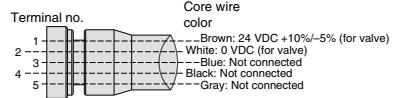

Made to Order

Cable length	10000 mm	p. 1475
--------------	----------	---------

### PCA-1401804

Cable length (L)

1401804	1500 mm
1401805	3000 mm
1401806	5000 mm



Socket connector pin arrangement  
A-coded

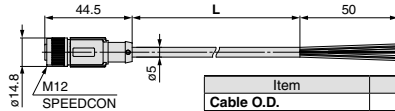

Item	Specifications
Cable O.D.	ø5 mm
Conductor nominal cross section	0.34 mm <sup>2</sup> /AWG22
Wire O.D. (Including insulator)	1.27 mm
Min. bending radius (Fixed)	21.7 mm

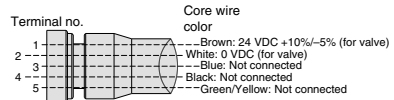

## ⑦ DIN Rail Bracket (2 pcs.)

Bracket for mounting the input unit (EX500-DXPA, EX500-DXPB) to DIN rail.

### EX500-ZMA1

<Example of use>

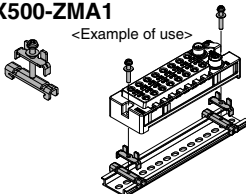

## ⑧ Marker (1 sheet, 88 pcs.)

Signal name of the input device such as a switch can be written on the marker and installed to the input unit.

### EX600-ZT1

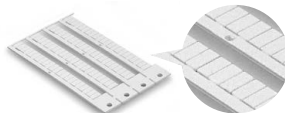

## ⑨ Seal Cap (10 pcs.)

Use with new connector. By using these seal caps, the new connector maintains IP65/67 enclosure.

### EX9-AWES

For M8 connector socket

### EX9-AWTS

For M12 connector socket



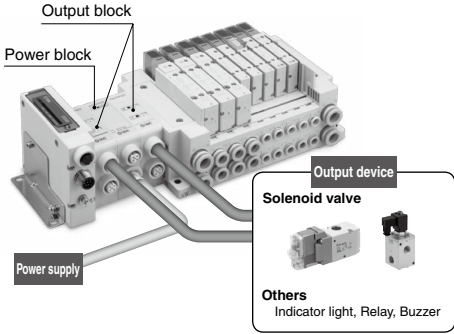

- Output devices other than valve manifold can be operated.
- By using the power block and output block for high watt load, operation up to 0.5 A/point can be performed.
- Possible to mount the output block and power block additionally between the SI unit and the valve (The surplus I/O points are used).
- 2 point outputs per output block (M12 connector)

You are requested to connect it to an SI unit and a valve manifold. For detailed specifications, refer to the operation manual that can be downloaded from SMC website, <https://www.smcworld.com>

## ⑩ Output Block

### EX9-OE T 1

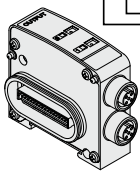

● **Output specification**  
1 Source/PNP (Negative common)

● **Power supply type**  
T Internal power supply method (for low-wattage load)  
P Integrated power supply method (for high-wattage load) \*1  
\*1 Required to connect with a power block

### Dimensions/Parts Description

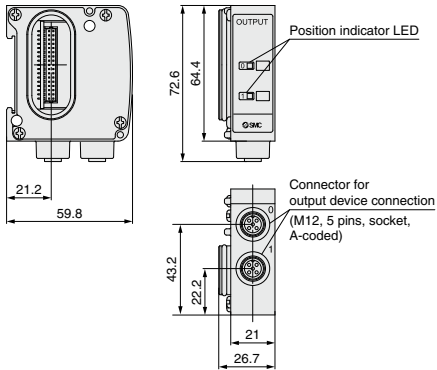

## ⑪ Power Block

### EX9-PE1

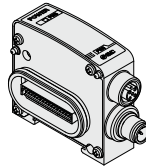

### Dimensions/Parts Description

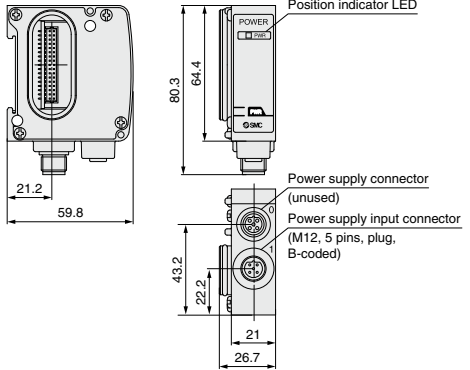

## Specifications

Model	EX9-OET1	EX9-OEP1
Internal current consumption	40 mA or less	
Output	Output type	Source/PNP (Negative common)
	Number of outputs	2 outputs
	Power supply method	Internal power supply method Integrated power supply method (Power block supplied from EX9-PE1)
	Output device supply voltage	24 VDC
	Output device supply current	Max. 42 mA/point (1.0 W/point)   Max. 0.5 A/point (12 W/point)
Environmental resistance	Enclosure	IP67
	Operating temperature range	-10 to 50°C
	Operating humidity range	35 to 85%RH (No condensation)
Standards	CE/UKCA marking, UL (CSA)	
Weight	120 g	

## Specifications

Model	EX9-PE1	
Connection block	Output block for high wattage load	
Connection block stations	Output block: Max. 8 stations	
Power supply for output and internal control	Power supply voltage	22.8 to 26.4 VDC
	Internal current consumption	20 mA or less
Supply current	Max. 3.1 A*1	
Environmental resistance	Enclosure	IP67
	Operating temperature range	-10 to 50°C
	Operating humidity range	35 to 85%RH (No condensation)
Standards	CE/UKCA marking, UL (CSA)	
Weight	120 g	
Enclosed parts	Seal cap (for M12 connector) 1 pc.	

\*1 When using with 3.0 to 3.1 A, the ambient temperature should not exceed 40°C, and do not bundle the cable.



# EX500 Series

## ⑫ Power Supply Cable (For power block)

Supplies power to the power block.

**Straight connector type**

### EX9-AC 050 -1

● Cable length (L)

010	1000 mm
030	3000 mm
050	5000 mm

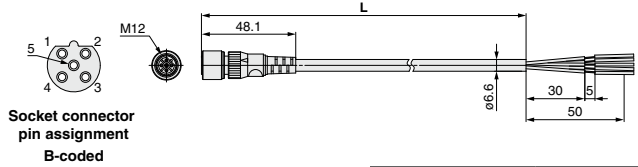

Item	Specifications
Cable O.D.	ø6.6 mm
Conductor nominal cross section	0.3 mm <sup>2</sup> /AWG22
Wire O.D. (Including insulator)	1.65 mm
Min. bending radius (Fixed)	40 mm



**Made to Order**

Cable length	10000 mm	p. 1475
--------------	----------	---------

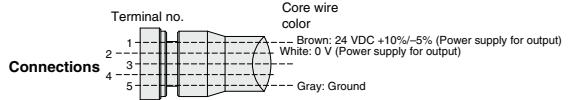

### PCA-1401807

● Cable length (L)

1401807	1500 mm
1401808	3000 mm
1401809	5000 mm

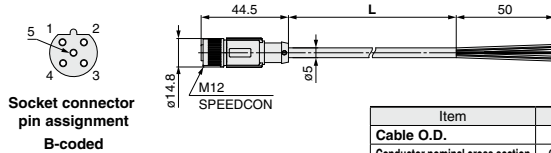

Item	Specifications
Cable O.D.	ø5 mm
Conductor nominal cross section	0.34 mm <sup>2</sup> /AWG22
Wire O.D. (Including insulator)	1.27 mm
Min. bending radius (Fixed)	21.7 mm

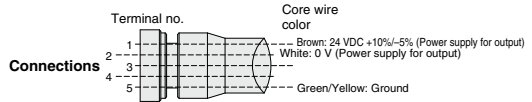

### 13 Connector for Output Block Wiring

Field-wireable connector for connecting an output device to an output block

#### PCA-1557743

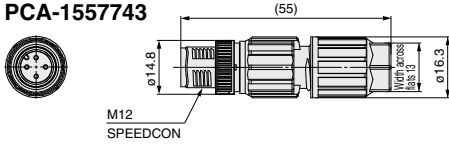

#### A-coded



Plug pin arrangement

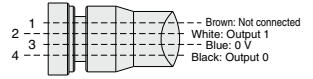

Connections

#### Applicable Cable

Item	Specifications
Cable O.D.	3.5 to 6.0 mm
Wire gauge (Stranded wire cross section)	0.14 to 0.34 mm <sup>2</sup> /AWG26 to 22
Core wire diameter (Including insulating material)	0.7 to 1.3 mm

#### PCA-1557756

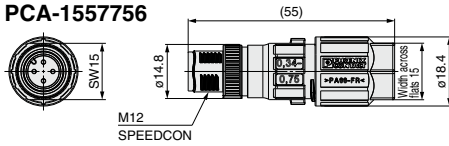

#### A-coded



Plug pin arrangement

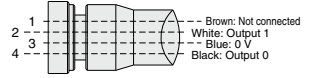

Connections

#### Applicable Cable

Item	Specifications
Cable O.D.	4.0 to 8.0 mm
Wire gauge (Stranded wire cross section)	0.34 to 0.75 mm <sup>2</sup> /AWG22 to 18
Core wire diameter (Including insulating material)	1.3 to 2.5 mm

### 14 End Plate

Use when an output block is not being used and a valve manifold is not connected.

#### EX9-EA03

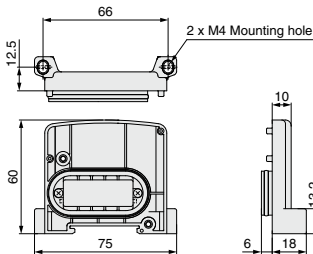

<Example of use>

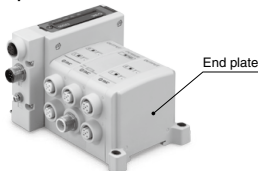

### 15 Bracket Plate/DIN Rail Mounting Bracket

A reinforcing brace used to mount an output block or power block onto an SI unit

To prevent connection failure between products due to deflection, use this bracket plate whenever an output block or power block is mounted.

#### EX9-BP1

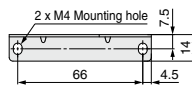

#### EX9-BD1

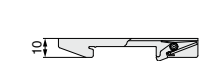
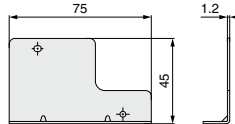
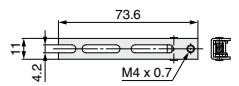

#### Accessory

Description	Qty.
Hexagon socket head cap screw (M3 x 35)	2

#### Accessory

Description	Qty.
Domed cap nut (M4)	1
Round head combination screw (M4 x 8)	1
Round head combination screw (M4 x 10)	1

<Example of use>

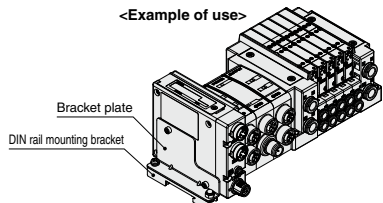



# EX500 Series

## Specific Product Precautions

Be sure to read this before handling the products. Refer to page 7 for safety instructions and pages 15 to 17 for fieldbus system precautions.

### Operating Environment

#### Caution

1. **Select the proper type of enclosure according to the operating environment.**

IP65/67 is achieved when the following conditions are met.

- 1) Provide appropriate wiring between the products using electrical wiring cables, communication connectors and cables with M12 connectors.
- 2) Suitable mounting of the product and valve manifold.
- 3) Be sure to mount a seal cap on any unused connectors.

If using in an environment that is exposed to water splashes, please take measures such as using a cover.

### Adjustment / Operation

#### Warning

<Web server function>

1. **The valve operation test is a function which forcibly changes the signal status. Please check safety of the ambient environment and the device before using this function.**

This may cause injuries or equipment damage.

2. **If the communication line and PC are shut down during a valve operation test, the valve output status will be held (It remains in the output status before the communication line and/or PC was shut down). Please check safety of the ambient environment and the device when performing this function.**

This may cause injuries or equipment damage.

#### ■ Trademark

EtherNet/IP® is a registered trademark of ODVA, Inc.  
QuickConnect™ is a trademark of ODVA.