

5 Port Air Operated Valve

VFRA3000 Series

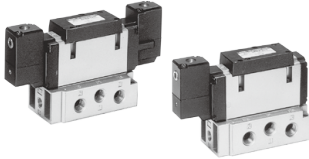

How to Order

VFRA3 2 11 - 02

Type of actuation

1	2 position single
2	2 position double
3	3 position closed center
4	3 position exhaust center
5	3 position pressure center

Thread type
(Including pilot port)

NII	Rc
F	G
N	NPT
T	NPTF

Port size

NII	Without sub-plate (Pilot port: Rc)
00	Without sub-plate (Pilot port: Other than Rc)
02	1/4
03	3/8

How to Order Manifold Base

VV5FRA3 - 10 - ¹/₂ -

n Port size Thread type

Indicate the same part number as VFR3000 manifold.
<Example> VV5FR3-10-□1-□, VV5FR3-10-□2-□

* To order valves and blanking plate assembly mounted onto the manifold, list valves and blanking plate assembly with manifold base part number.

<Example> **VV5FRA3-10-061-03**..... 1 pc.

*VFRA3111..... 5 pcs.

*VVFS3000-10A..... 1 pc.

▶ To order valves and options mounted onto the manifold at the factory, list the valve/option with an asterisk (*) in front of each part number.

5 Port Air Operated Valve **VFRA3000 Series**

Symbol

2 position single

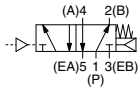

3 position closed center

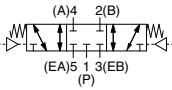

2 position double

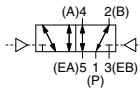

3 position exhaust center

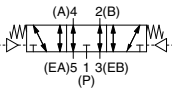

3 position pressure center

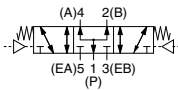

Specifications

Fluid		Air
Operating pressure range ⁽¹⁾ (MPa)	2 position single	0.2 to 0.9
	2 position double	0 to 0.9
	3 position	0 to 0.9
Pilot pressure range (MPa)	2 position single	(0.6 x P + 0.1) to 0.9, P: Operating pressure
	2 position double	0.1 to 0.9
	3 position	0.2 to 0.9
Ambient and fluid temperature (°C)		-10 to 60 (No freezing)
Lubrication ⁽²⁾		Not required
Mounting orientation		Free
Impact/Vibration resistance (m/s ²) ⁽³⁾		300/50

Note 1) In case of single type, be certain that supply pressure within operating pressure range be supplied to supply port, because return pressure is introduced from supply port 1(P) for activation.

Note 2) Use turbine oil Class 1 (ISO VG32) if lubricating.

Note 3) Impact resistance: No malfunction from test using drop impact tester, to axis and right angle directions of main valve, each one time when pilot signal is ON and OFF. (Value in the initial stage)

Vibration resistance: No malfunction from test with 45 to 2000 Hz one sweep, to axis and right angle direction of main valve, each one time when pilot signal ON and OFF. (Value in the initial stage)

⚠ Caution

Be sure to read this before handling the products. Refer to page 8 for safety instructions and pages 9 to 15 for 3/4/5 port solenoid valve precautions.

Pilot Pressure Range (Single Pilot)

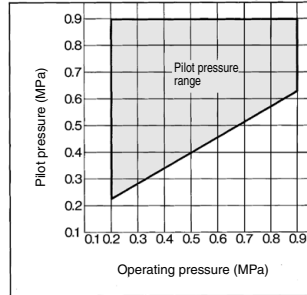

Flow Rate Characteristics/Weight

Valve model	Function	Port size	Flow rate characteristics						Pilot port size	Weight (kg)
			1→4/2(P→A/B)			4/2→5/3(A/B→EA/EB)				
			C[dm ³ /(s·bar)]	b	Cv	C[dm ³ /(s·bar)]	b	Cv		
VFRA3111-02	2 position Single	1/4	7.5	0.38	1.9	7.5	0.34	1.9	1/8	0.61
VFRA3111-03		3/8	8.4	0.39	2.2	8.7	0.38	2.2		
VFRA3211-02		1/4	7.1	0.41	1.9	7.4	0.40	1.9		
VFRA3211-03	2 position Double	3/8	7.9	0.36	2.0	8.6	0.37	2.2	1/8	0.71
VFRA3311-02		1/4	6.8	0.40	1.8	6.3	0.38	1.6		
VFRA3311-03		3/8	7.2	0.39	1.9	6.5	0.40	1.7		
VFRA3411-02	3 position Closed center	1/4	6.5	0.42	1.7	7.9 (3.4)	0.41 (0.47)	2.0 (0.96)	1/8	0.72
VFRA3411-03		3/8	6.9	0.42	1.8	9.5 (3.4)	0.39 (0.46)	2.4 (0.96)		
VFRA3511-02		3 position Exhaust center	1/4	7.6 (2.4)	0.33 (0.48)	1.9 (0.69)	6.1	0.36		
VFRA3511-03	3/8		9.3 (2.4)	0.34 (0.47)	2.2 (0.69)	6.5	0.41	1.7		

Note) (): Normal position

VFRA3000 Series

Dimensions

2 position single: VFRA3111-02 03

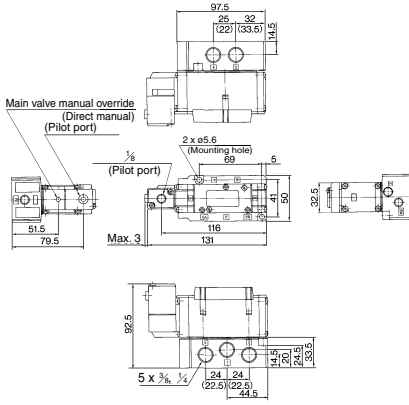

(): In the case of Rc 1/4

2 position double: VFRA3211-02 03

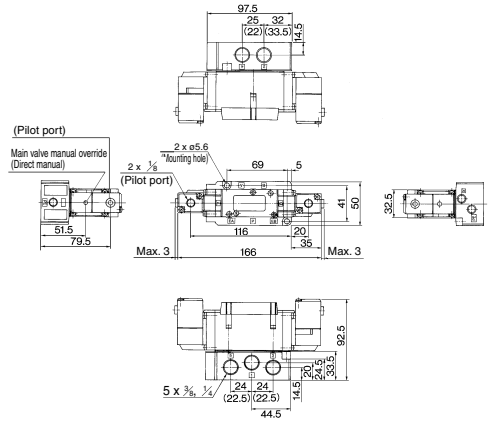

(): In the case of Rc 1/4

3 position closed center: VFRA3311-02 03

3 position exhaust center: VFRA3411-02 03

3 position pressure center: VFRA3511-02 03

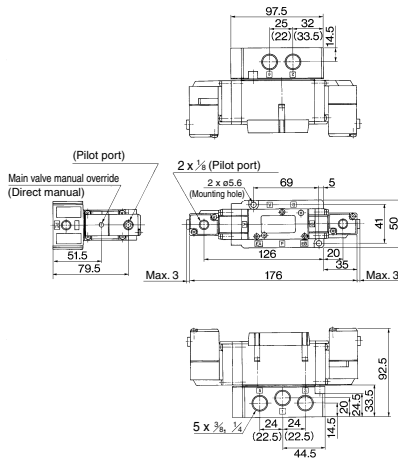

(): In the case of Rc 1/4

5 Port Air Operated Valve

VFRA4000 Series



How to Order

VFRA4 2 11 - 03

Type of actuation

1	2 position single
2	2 position double
3	3 position closed center
4	3 position exhaust center
5	3 position pressure center

Thread type
(Including pilot port)

NII	Rc
F	G
N	NPT
T	NPTF

Port size

NII	Without sub-plate (Pilot port: Rc)
00	Without sub-plate (Pilot port: Other than Rc)
03	3/8
04	1/2

How to Order Manifold Base

VV5FRA4 - 10 - ¹/₂ -

n
Port size
Thread type

Indicate the same part number as VFR4000 manifold.
 <Example> VV5FR4-10-□1-□, VV5FR4-10-□2-□

<Example>

VV5FRA4-10-061-03.....1 pc.

*VFRA4111.....5 pcs.

±VVFS4000-10A.....1 pc.

↳ To order valves and options mounted onto the manifold at the factory, list the valve/option with an asterisk (*) in front of each part number.

VFRA4000 Series

Symbol

2 position single 3 position closed center

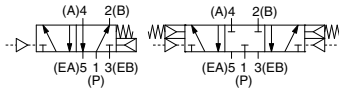

2 position double 3 position exhaust center

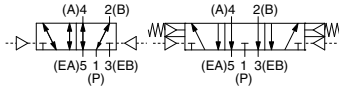

3 position pressure center

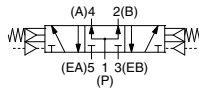

Specifications

Fluid		Air
Operating pressure range (MPa)	2 position single	0.2 to 0.9
	2 position double	0 to 0.9
	3 position	0.2 to 0.9
Pilot pressure range (MPa)	2 position single	$(0.6 \times P + 0.1)$ to 0.9, P: Operating pressure
	2 position double	0.1 to 0.9
	3 position	$(0.6 \times P + 0.1)$ to 0.9, P: Operating pressure
Ambient and fluid temperature (°C)		-10 to 60 (No freezing)
Lubrication ⁽²⁾		Not required
Mounting orientation		Free
Impact/vibration resistance (m/s²) ⁽³⁾		300/50

Note 1) In case of single type, be certain that supply pressure within operating pressure range be supplied to supply port, because return pressure is introduced from supply port 1(P) for activation.

Note 2) Use turbine oil Class 1 (ISO VG32), if lubricating.

Note 3) Impact resistance: No malfunction from test using drop impact tester, to axis and right angle directions of main valve, each one time when pilot signal is ON and OFF. (Value in the initial stage)

Vibration resistance: No malfunction from test with 45 to 2000 Hz one sweep, to axis and right angle direction of main valve, each one time when pilot signal ON and OFF. (Value in the initial stage)

Pilot Pressure Range (Single pilot or 3 position)

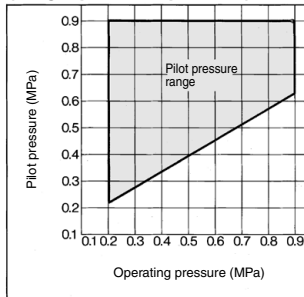

⚠ Caution

Be sure to read this before handling the products. Refer to page 8 for safety instructions and pages 9 to 15 for 3/4/5 port solenoid valve precautions.

Flow Rate Characteristics/Weight

Valve model	Function	Port size	Flow rate characteristics						Pilot port size	Weight (kg)	
			1→4/2(P→A/B)			4/2→5/3(A/B→EA/EB)					
			C[dm ³ /(s·bar)]	b	Cv	C[dm ³ /(s·bar)]	b	Cv			
VFRA4111-03	2 position	Single	3/8	13	0.30	3.2	14	0.28	3.4	1/8	1.1
VFRA4111-04			1/2	15	0.30	3.8	14	0.30	3.8		
VFRA4211-03		Double	3/8	14	0.31	3.4	14	0.26	3.4		
VFRA4211-04			1/2	15	0.30	4.0	14	0.30	3.7		
VFRA4311-03	3 position	Closed center	3/8	13	0.32	3.2	13	0.25	3.0	1/8	1.2
VFRA4311-04			1/2	14	0.28	3.5	13	0.29	3.4		
VFRA4411-03		Exhaust center	3/8	13	0.31	3.2	14(13)	0.32(0.3)	3.6(3.2)		
VFRA4411-04			1/2	14	0.30	3.7	14(13)	0.32(0.3)	3.6(3.2)		
VFRA4511-03		Pressure center	3/8	13(5.0)	0.27(0.42)	3.2(1.3)	13	0.28	3.1		
VFRA4511-04			1/2	15(5.3)	0.22(0.42)	3.7(1.5)	13	0.28	3.3		

Note) (): Normal position

Dimensions

2 position single: VFRA4111-⁰³/₀₄

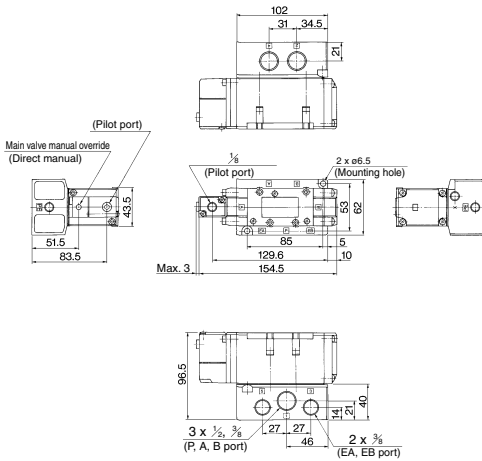

2 position double: VFRA4211-⁰³/₀₄

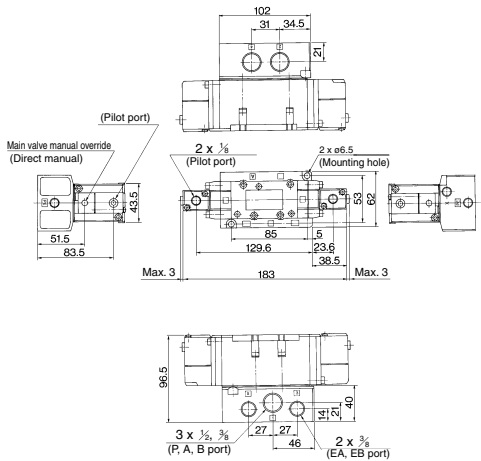

3 position closed center: VFRA4311-⁰³/₀₄

3 position exhaust center: VFRA4411-⁰³/₀₄

3 position pressure center: VFRA4511-⁰³/₀₄

