

Speed Controller: Standard Type Large Flow In-line Type

AS Series

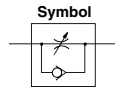

Able to control and set a constant speed easily.
Speed may be accurately controlled even at low speed.
Retainer prevents accidental loss of needle.



Caution
Be sure to read this before handling the products.
Refer to page 11 for safety instructions and pages 19 to 22 for flow control equipment precautions.

Model

Model	Port size	Free flow			Controlled flow			Weight (kg)
		Flow rate (L/min (ANR))	Sonic conductance (dm ³ /s(bar))	Critical pressure ratio	Flow rate (L/min (ANR))	Sonic conductance (dm ³ /s(bar))	Critical pressure ratio	
AS420-02	1/4	2,500	6.9	0.25	3,600	10	0.45	0.34
AS420-03	3/8	5,000	13.9		4,800	13.3		0.33
AS420-04	1/2	6,600	18.3		6,700	18.6		0.32
AS500-06	3/4	10,100	28.1		8,100	22.5		0.36
AS600-10	1	15,100	42		16,900	47		0.7
AS800-12	1 1/4	35,400	98		38,500	107		1.4
AS900-14	1 1/2	52,000	144		47,500	132		3.3
AS900-20	2	57,800	161		60,800	169		3.3

Note) Flow rate values are measured at 0.5 MPa and 20°C.

Specifications

Fluid	Air
Proof pressure	1.5 MPa
Max. operating pressure	1 MPa
Min. operating pressure	0.05 MPa
Ambient and fluid temperature	-5 to 60°C (No freezing)

How to Order

AS 42 0 - [] 02 - []

Body size

42	1/2 standard
50	3/4 standard
60	1 standard
80	1 1/4 standard
90	1 1/2 standard

Thread type

Nil	Rc
N	NPT
F	G

Bore size

Bore size	Applicable series
02	1/4
03	3/8
04	1/2
06	3/4
10	1
12	1 1/4
14	1 1/2
20	2

Option

Nil	None
H ⁽¹⁾	High temperature (-5 to 80°C)
L ⁽²⁾	Low temperature (-30 to 60°C)

Note 1) AS800 is available as special.
Note 2) AS900 is available as special.

Needle Valve/Flow Rate Characteristics

Note) The flow rate characteristics are representative values.

AS420

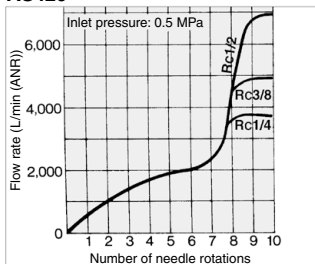

AS500/600

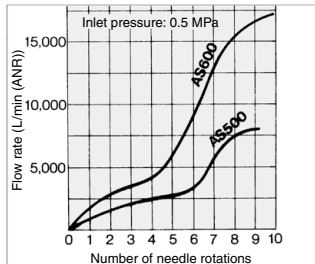

AS800/900

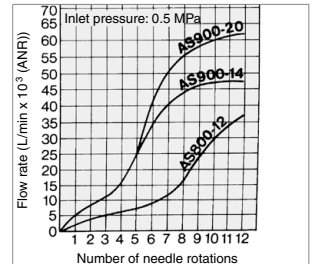

Construction: AS420/500/600

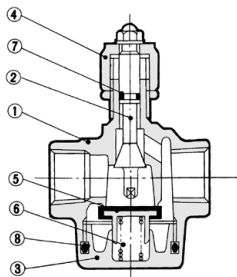

Component Parts

No.	Description	Material
1	Body	Aluminum alloy
2	Needle	Brass
3	Bottom cover	Aluminum alloy
4	Handle	Zinc alloy

Replacement Parts

No.	Description	Material	Part no.	
			AS420-500	AS600
5	Check Valve	NBR, Brass	14254	14273
6	Spring	Stainless steel	14255	14275
7	O-ring	NBR	KA00476	KA00476
8	O-ring	NBR	KA00472	KA00474

Dimensions: AS420/500/600

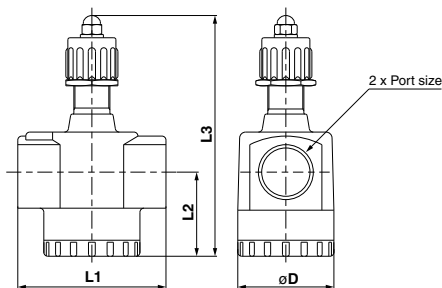

Dimensions

Model	Port size	L1	L2	L3 (1)		D
				Max.	Min.	
AS420	1/4, 3/8, 1/2	67.5	38	122	112	50
AS500	3/4	74	42	115	105	50
AS600	1	90	55	158	148	62

Note 1) L3: Reference dimensions

Construction: AS800/900

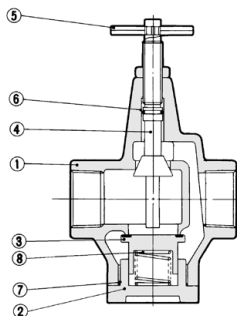

Component Parts

No.	Description	Material
1	Body	Aluminum alloy
2	Valve guide	Aluminum alloy
3	Check valve	NBR, Brass
4	Needle	Brass
5	Handle	Carbon steel

Replacement Parts

No.	Description	Material	Part no.	
			AS800	AS900
6	O-ring	NBR	KA00069	KA00072
7	O-ring	NBR	KA00460	KA00462
8	Spring	Stainless steel	14115	14124

Dimensions: AS800/900

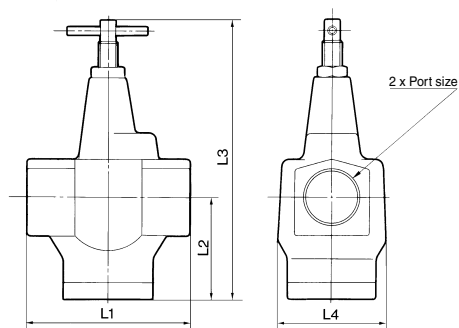

Dimensions

Model	Port size	L1	L2	L3 (1)		L4
				Max.	Min.	
AS800	1 1/4	120	74	204	192	80
AS900	1 1/2, 2	150	93	262	250	94

Note 1) L3: Reference dimensions