



ORIGINAL INSTRUCTIONS



Refer to Declaration of Conformity for relevant Directives

Instruction Manual
Soft Start-up Valve

AV(A)2000, AV(A)3000, AV(A)4000, AV(A)5000

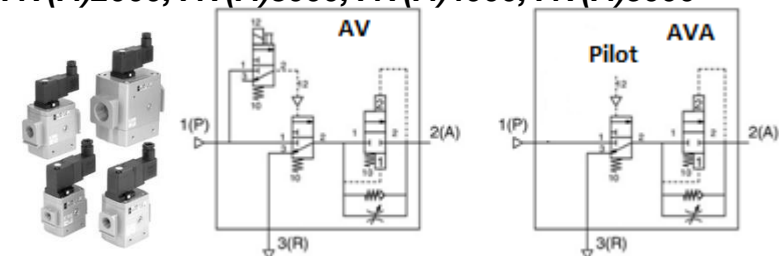

The intended use of a start-up valve is for low speed air supply to gradually raise initial pressure in an air system to protect machines during start up.

1 Safety Instructions

These safety instructions are intended to prevent hazardous situations and/or equipment damage. These instructions indicate the level of potential hazard with the labels of "Caution," "Warning" or "Danger." They are all important notes for safety and must be followed in addition to International Standards (ISO/IEC¹⁾, and other safety regulations.

¹⁾ ISO 4414: Pneumatic fluid power - General rules relating to systems.
ISO 4413: Hydraulic fluid power - General rules relating to systems.
IEC 60204-1: Safety of machinery - Electrical equipment of machines. (Part 1: General requirements)
ISO 10218-1: Manipulating industrial robots - Safety, etc.

- Refer to product catalogue, Operation Manual and Handling Precautions for SMC Products for additional information.
- Keep this manual in a safe place for future reference.

2 Specifications - continued

Variant	AV(A)3000
Port size	3/8"
Response time, t (Note 4)	35 ms
Effective Area 1 (P) → 2 (A)	37 mm ²
Effective Area 2 (A) → 3 (R)	49 mm ²
Weight	0.48 kg

Table 3

Variant	AV(A)4000
Port size	1/2"
Response time, t (Note 4)	50ms
Effective Area 1 (P) → 2 (A)	61mm ²
Effective Area 2 (A) → 3 (R)	76mm ²
Weight	0.74 kg

Table 4

Variant	AV(A)5000
Port size	3/4" 1"
Response time, t (Note 4)	100 ms
Effective Area 1 (P) → 2 (A)	113 mm ² 122 mm ²
Effective Area 2 (A) → 3 (R)	132 mm ² 141 mm ²
Weight	1.60 kg 1.54 kg

Table 5

Note 1) Use dry air when operating at a low temperature

2.3 Electrical Specifications

(Not applicable to AVA air operated variants)

Rated coil voltage VAC	100, 110 to 120, 200, 220, 240 (50/60Hz)
Rated coil voltage VDC	12, 24
Allowable voltage fluctuation	-15% to +10% of rated voltage
Coil Insulation type	Equivalent to Type B (130°C)
Apparent power	Inrush 5.6 VA (50Hz), 5.0 VA (60Hz)
AC (current)	Energised 3.4VA(2.1W)/50Hz 2.3VA(1.5W)/60Hz
Current consumption (DC)	1.8 W

Electrical Entry	Grommet, Type D DIN connector, Type Y DIN connector
Ingress protection	IP40
Pilot valve manual override	Non-locking push type (Flush), Locking type (Tool required), Locking type (Lever)

Table 6

3 Installation

3.1 Installation

Warning

- Do not install the product unless the safety instructions have been read and understood.
- Allow sufficient space for maintenance and inspection
- Check fixings while pressure and power are applied. Initial function and leakage tests should be performed after installation.
- Provide ventilation when using a valve in a confined space such as a closed control panel. E.g. install a ventilation opening, etc. in order to prevent pressure from increasing inside the confined area and to release the heat generated by the valve.
- Prevent the lead wire being exposed to forces which might affect the wiring or function of the valve.

3.2 Environment

Warning

- Do not use in an environment where corrosive gases, chemicals, salt water or steam are present.
- Do not use in an explosive atmosphere.
- Do not expose to direct sunlight. Use a suitable protective cover.
- Do not install in a location subject to vibration or impact in excess of the product's specifications.
- Do not mount in a location exposed to radiant heat that would result in temperatures in excess of the product's specifications.

3 Installation - continued

3.3 Piping

Caution

- Before connecting piping make sure to clean up chips, cutting oil, dust etc.
- When installing piping or fittings, ensure sealant material does not enter inside the port. When using seal tape, leave 1.5 to 2 thread ridges exposed on the end of the pipe/fitting.
- Tighten fittings to the specified tightening torque.

Connection threads	Proper tightening torque (Nm)
Rc 1/4	12 to 14
Rc 3/8	22 to 24
Rc 1/2	28 to 30
Rc 3/4	28 to 30
Rc 1	36 to 38

Table 7

- When piping to product, avoid connecting to the wrong port. Refer to operation manual available on www.smcworld.com.
- The nominal size of the piping material's or equipment's bore should be equal to or larger than the soft start-up valve's port size. The composite effective area of the inlet side's (P port side's) piping or equipment should be equal to or larger than the values below

Model	Composite effective area (mm ²)
AV(A)2000	5
AV(A)3000	22
AV(A)4000	35
AV(A)5000	50

Table 8

- When connecting to a modular F.R.L. combination (AC20 to AC60), select one of the spacers, which are included. Note modular combinations with AC40-06 are not possible. Connect soft start-up valves to the outlet side of the F.R.L. combination.

- Always connect soft start-up valves to the outlet side of the F.R.L. combination.

Model	Part number	
	No bracket	Bracket
AV(A)2000	Y200	Y200T
AV(A)3000	Y300	Y300T
AV(A)4000	Y400	Y400T
AV(A)5000	Y600	Y600T

Table 9

3.4 Lubrication

Caution

- SMC products have been lubricated for life at manufacture, and do not require lubrication in service.
- If a lubricant is used in the system, refer to catalogue for details.

3.5 Air supply

Caution

- When extremely dry air is used as the fluid, degradation of the lubrication properties inside the equipment may occur, resulting in reduced reliability (or reduced service life) of the equipment.
- Install an air filter
- Install an air filter upstream near the valve. Select an air filter with a filtration size of 5µm or smaller.
- Take measures to ensure air quality, such as by installing an aftercooler, air dryer, or water separator.

4 Settings

4.1 Manual Override

Warning

- Since connected equipment will operate when the manual override is activated, confirm that conditions are safe prior to activation.

Operation

Push type (Figure 1A)

Push on the manual override button using a small flat-bladed screwdriver or suitable tool in the button dimple until it stops ON.

- Hold this position for the duration of the check (ON position).
- Release the button and the override will re-set to OFF position.

Locking type (Figure 1B)

Turn the screw-type head clockwise using a flat blade tool until it locks ON. Turn the screw type head anticlockwise to turn OFF and lock in the OFF position.

Lever locking type (Figure 1C)

Turn the lever clockwise until it locks ON. Turn the lever anticlockwise to turn OFF and lock in the OFF position.

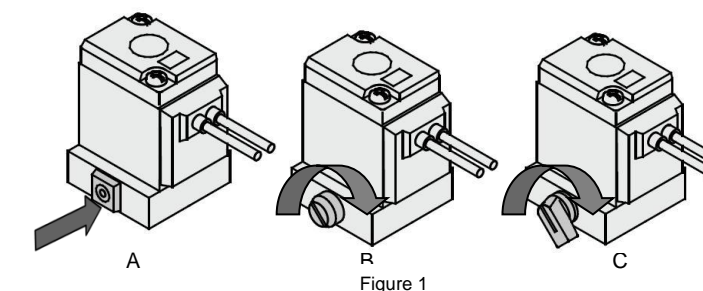

4.2 Adjustment

Caution

- To perform the initial speed adjustment of an outlet side actuator, supply air from this valve's inlet side and turn ON the pilot valve or supply pressure to the pilot port.

- Then, rotate the needle valve counter-clockwise from the fully closed position.
- If the needle valve is completely closed:
 - When energized or when pilot pressure is supplied, the valve will not supply compressed air to port 2 (A)
 - When de-energised or the pilot port is vented the cracking pressure of the check valve will tend to maintain 0.02 MPa at port 2 (A).

4.3 Light/Surge Voltage Suppressor

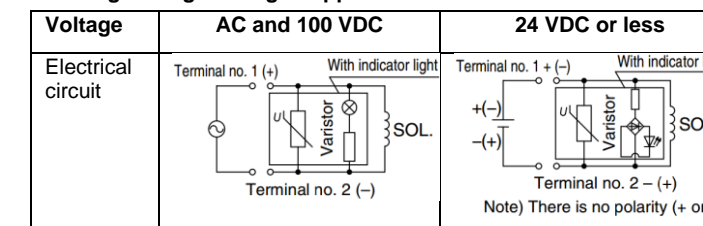
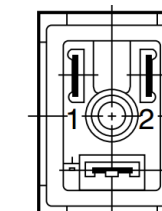

Table 10

4.4 Electrical Connection

The internal connection of the DIN terminal is as shown below, connect to the power supply side as shown.



Terminal	1	2
DIN terminal	+	-

Table 11

2 Specifications

2.1 General Specifications

Series	AV
Fluid	Air
Proof pressure	1.5 MPa
Operating pressure range	0.2 to 1.0 MPa
Pressure gauge port size	1/8"
Max. operating frequency	100 times / day
Min. operating frequency	Once every 30 days
Duty cycle	Continuous
Lubrication	Not required

Table 1

2.2 Variant specifications

Variant	AV(A)2000
Port size	1/4"
Response time, t (Note 4)	25 ms
Effective Area 1 (P) → 2 (A)	20 mm ²
Effective Area 2 (A) → 3 (R)	24 mm ²
Weight	0.27 kg

Table 2

4 Settings - continued

4.5 Leakage voltage

Ensure that any leakage current when the switching element is OFF causes is less than the voltage given in Figure 7 across the valve

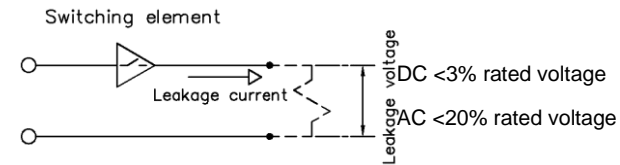

Figure 2

4.6 Surge voltage from external power isolation

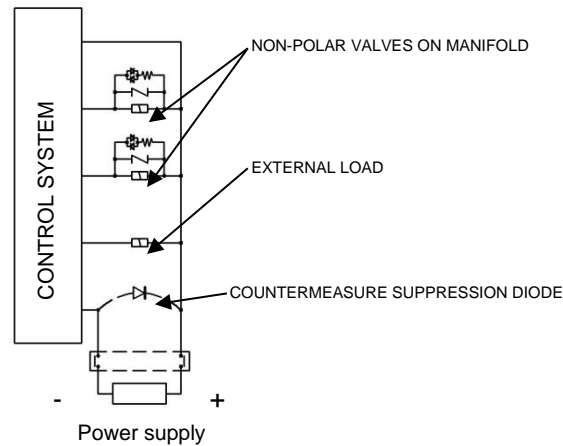

Figure 3

Countermeasures are required if non-polar valves are used in a system with a power supply isolating device.

When the power supply is suddenly isolated due to emergency stop etc, transient surge voltage can be caused by energy stored in energised

devices within the control system. This transient voltage can cause non-polar valves to be temporarily energised.

As a countermeasure, a power supply suppression diode should be fitted within the control system as shown. Contact SMC for more details.

5 How to Order

Refer to catalogue for 'How to Order'.

6 Outline Dimensions (mm)

Refer to catalogue for outline dimensions.

7 Maintenance

7.1 General Maintenance

Caution

- Not following proper maintenance procedures could cause the product to malfunction and lead to equipment damage.
- If handled improperly, compressed air can be dangerous.
- Maintenance of pneumatic systems should be performed only by qualified personnel.
- Before performing maintenance, turn off the power supply and be sure to cut off the supply pressure. Confirm that the air is released to atmosphere.
- After installation and maintenance, apply operating pressure and power to the equipment and perform appropriate functional and leakage tests to make sure the equipment is installed correctly.
- If any electrical connections are disturbed during maintenance, ensure they are reconnected correctly and safety checks are carried out as required to ensure continued compliance with applicable national regulations.
- Do not make any modification to the product.
- Do not disassemble the product, unless required by installation or maintenance instructions.
- Equipment removal and supply/exhaust of compressed air.

When equipment is removed, first confirm that measures are implemented to prevent dropping of workpiece and runaway of equipment, etc. Then cut the supply pressure and power and exhaust

7 Maintenance - continued

all compressed air from the system using its residual pressure release function.

- Manual override operation.
Since connected equipment will operate when the manual override is activated, confirm that conditions are safe prior to activation.

8 Limitations of Use

8.1 Limited warranty and Disclaimer/Compliance Requirements

Refer to Handling Precautions for SMC Products.

- **Do not use for holding pressure.**
Since the valve might have slight internal leakage, it is not suitable for holding pressure in a tank or another vessel for a long period of time.
- **Extended periods of continuous energisation.**
Contact SMC if valves will be continuously energized for continuous periods of time.
- **Operation of closed centre solenoid valves.**
Even if this product is used for closed centre solenoid valves or actuator with a load factor of more than 50%, jumping (stick-slip phenomenon) cannot be prevented.
- **Using a regulator on the outlet side.**
When mounting a regulator on the outlet side (A port side), use a residual pressure relief regulator (AR25K to 40K) or check type regulator. With a standard regulator (AR10 to 60), the outlet side pressure may not be released when this valve is exhausted.
- **Operation of solenoid valves on the outlet side.**
To operate solenoid valves mounted on this product's outlet side (A port side) first confirm that the outlet side's pressure (P_A) has increased to become equal to the inlet side's pressure (P_P).
- **Operation.**
The residual pressure release function of this product is for emergency use only; therefore, avoid the operation in the same manner as ordinary 3 port valves.
- **Using a lubricator.**
If mounting a lubricator, mount in on the inlet side (P port side) of this product. If mounted on the outlet side (A port side), back flow of oil will

occur and may spurt out of the valve's R port.

- **Operation for air blowing.**
This product cannot be operated for air blowing due to the mechanism that switches the main valves to be fully open after the outlet side's pressure increases to approximately 1/2 of the inlet side.

Warning

If a safe output from a safety relay or PLC is used to operate this valve, ensure that any output test pulse duration is shorter than 1 ms to avoid the valve solenoid responding.

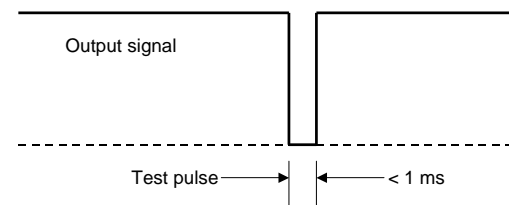

9 Product disposal

This product should not be disposed of as municipal waste. Check your local regulations and guidelines to dispose this product correctly, in order to reduce the impact on human health and the environment.

10 Contacts

Refer to www.smcworld.com or www.smc.eu for contacts.

SMC Corporation

URL : <http://www.smcworld.com> (Global) <http://www.smceu.com> (Europe)
SMC Corporation, Akihabara UDX15F, 4-14-1, Sotokanda, Chiyoda-ku, Tokyo 101 0021
Specifications are subject to change without prior notice from the manufacturer.
© 2020 SMC Corporation All Rights Reserved.
Template DKP50047-F-0851