



ORIGINAL INSTRUCTIONS

## Instruction Manual

## Ionizer

## IZT44 / 45 series



The intended use of this product is to neutralize charged objects.

## 1 Safety Instructions

These safety instructions are intended to prevent hazardous situations and/or equipment damage. These instructions indicate the level of potential hazard with the labels of "Caution," "Warning" or "Danger."

They are all important notes for safety and must be followed in addition to International Standards (ISO/IEC)<sup>1)</sup>, and other safety regulations.

<sup>1)</sup> ISO 4414: Pneumatic fluid power — General rules and safety requirements for systems and their components.

ISO 4413: Hydraulic fluid power — General rules and safety requirements for systems and their components.

IEC 60204-1: Safety of machinery - Electrical equipment of machines. (Part 1: General requirements).

ISO 10218-1: Robots and robotic devices - Safety requirements for industrial robots - Part 1: Robots.

- Refer to the product catalogue, Operation Manual and Handling Precautions for SMC Products for additional information.
- Keep this manual in a safe place for future reference.

<b>Danger</b>	Danger indicates a hazard with a high level of risk which, if not avoided, will result in death or serious injury.
<b>Warning</b>	Warning indicates a hazard with a medium level of risk which, if not avoided, could result in death or serious injury.
<b>Caution</b>	Caution indicates a hazard with a low level of risk which, if not avoided, could result in minor or moderate injury.

**Warning**

- Always ensure compliance with relevant safety laws and standards.** All work must be carried out in a safe manner by a qualified person in compliance with applicable national regulations.
- This product may cause interference if used in residential premises.**
- Special products (-X) might have specifications different from those shown in the specifications section. Contact SMC for specific drawings.

## 2 Specifications

## 2.1 Specifications

Ionizer model		IZT44	IZT45
Ion generation method		Corona discharge type	
Method of applying voltage		Pulse AC, DC	
Applied voltage		+/- 7,000 V	
Current consumption		0.5A max.	0.6A max. (+0.5A max. per ionizer when connected)
Power supply voltage		24 VDC ±10% (100-240 VAC: AC adapter option applicable when only one bar is used)	
Switch input	NPN type	-	Range: 5 VDC max. Current consumption: 5 mA max.
	PNP type	-	Range: 19 VDC to supply voltage. Current consumption: 5 mA max.
Switch output	NPN type	Max. load current: 100 mA Residual voltage: 1 V max. (at 100 mA Load current). Max. supply voltage: 26.4 VDC.	Max. load current: 100 mA Residual voltage: 1 V max. (at 100 mA Load current). Max. supply voltage: 26.4 VDC.
	PNP type	Max. load current: 100 mA Residual voltage: 1 V max. (at 100 mA Load current).	Max. load current: 100 mA Residual voltage: 1 V max. (at 100 mA Load current).
Ambient temperature		0 to 40°C (Controller and HV power supply) 0 to 50°C (Ionizer Bar)	
Ambient humidity		35 to 80 %RH (no condensation)	

## 3 Installation

## 3.1 Installation

**Warning**

- Do not install the product unless the safety instructions have been read and understood.
- Reserve enough space for maintenance and wiring. Please take into consideration that the connectors need enough space to be easily attached/detached. To avoid unreasonable stress applied to the connector mounting parts, the bending radius of the cable should be more than the minimum bending radius. If the cable is bent in an acute angle or load is applied to the cable repeatedly, it may cause malfunction, wire damage or fire.  
Minimum bending radius: Power supply cable: 40 mm  
Separate cable (optional): 40 mm  
High voltage cable: 30 mm
- NOTE: This is an allowable bend radius at 20°C. Bend radius should be larger at lower than 20°C.
- Use the specified cable holder for installing high voltage cables.
- Follow the items below when installing high voltage cables.
  - Do not cut the cable.
  - Maintain the minimum bend radius of the cable.
  - Do not tighten the cable too much with a cable tie. Do not deform the cable by placing objects on the cable.
  - Avoid the factor of cable runaway such as cable duct.
  - Do not twist or damage to the cable. If the cable is damaged, it should be replaced.
- Fix the connector using 2 cross recessed round head screws (M4 x10) referring to the operation manual for this product. Mount to a flat surface and do not apply impact load or excessive external force. Mounting on an uneven surface will apply excessive force to the housing and bracket, which may lead to damage or failure.
- Do not drop or apply excessive shock to the product. Otherwise, damage or an accident may occur.
- Install the product so that the bar does not have an excessive deflection.
- Avoid using in a place where noise (electromagnetic wave and surge) is generated.

## 3 Installation (continued)

- Tighten the screws to the specified torque. Refer to the operation manual for this product.
- Do not directly touch the emitters. If your finger sticks to the needle, an electrical shock may cause an instantaneous rapid body motion to escape from the shock, causing injury. If the emitter or cartridge is damaged by tools, etc., it may interfere with the specified function and performance, and may also cause operation failure or an accident.
- Do not affix any tape or labels to the controller, high voltage power supply module or ionizer bar. If the tape or label contains any conductive adhesive or reflective paint, a dielectric phenomenon may occur due to ions arising from such substances, resulting in electrostatic charging or electric leakage, causing malfunction, breakage, electric shock or fire.
- Be sure to remove the power supply to the controller, high voltage power supply module and bar before product installation. If installation or adjustment is performed with power supplied, electric shock, failure or injury can result.
- The High voltage power supply module uses a fan. Provide 20 mm or more space from the exhaust port for ventilation.
- Do not carry this product by holding its cables.

**Caution**

- When IZT44/45 series is installed, keep space below free from structures or components.
- If there are electrically conductive objects such as walls or structures close to the bar/nozzle, generated ions may not reach the target object effectively or product failure or electric shock can result, due to dielectric or short-circuit.



- After installation, verify the performance of this product.
- When installing ionizers which operate in DC mode (one polarity, positive or negative) with IZT45 close together, they should be positioned at least

2 meters away from each other.

When IZT45 which operates in AC close to the Ionizer which operates in DC mode, separate them by at least 2 meters. The offset voltage (ion balance) may not be adjusted by the built-in sensor due to the ions discharged from the ionizer which is operating in DC mode.

- Use specified brackets for fixing.
- When the built-in sensor is ON and the ion balance cannot be adjusted to zero by pressing the button, turn the sensor OFF. The sensor may malfunction if there is an object with too much charge around it.

## 3.2 Environment

**Warning**

- Do not use in an environment where corrosive gases, chemicals, salt water or steam are present.
- Do not use in an explosive atmosphere.
- Do not expose to direct sunlight. Use a suitable protective cover.
- Do not install in a location subject to vibration or impact. Check the product specifications.
- Do not mount in a location exposed to radiant heat.
- Operate the product within the specified ambient temperature range. Ambient temperature range: Controller, High Voltage power supply module and AC adapter 0 to 40°C, ionizer bar 0 to 50°C. Do not use the product in locations where the temperature may change suddenly even if the ambient temperature range is within the specified limits, resulting in condensation.
- Do not use this product in an enclosed space. This product utilizes the corona discharge phenomenon. Do not use the product in an enclosed space as ozone and nitrogen oxides exist, even though in marginal quantities.
- Environments to avoid. Never use or store under the following conditions. These may cause an electric shock, fire, etc.
  - An environment which the ambient temperature is outside of the product specification.
  - An environment which the ambient humidity is outside of the product specification.

## 3 Installation (continued)

- Environment where abrupt temperature changes may cause condensation.
  - Environment where corrosive gas, flammable gas or other volatile flammable substances are stored.
  - Environment where the product may be exposed to conductive powder such as iron powder or dust, oil mist, salt, organic solvent, machining chips, particles or cutting oil (including water and any liquids), etc.
  - Paths of direct air flow, such as air conditioners.
  - Enclosed or poorly ventilated environment.
  - Locations which are exposed to direct sunlight or heat radiation.
  - Areas where strong electromagnetic noise is generated, such as strong electrical and magnetic fields or supply voltage spikes.
  - Environment where static electricity is generated to the product.
  - Locations where strong high frequency is generated.
  - Locations which are subject to potential lightning strikes.
  - In an area where the product may receive direct impact or vibration.
  - Areas where the product may be subjected to forces or weight that could cause physical deformation.
- The Controller, high voltage power supply module, bar and AC adapter are not resistant to lightning surge.

## 3.3 Installation of Ionizer Bar mounting bracket

- Fix the mounting bracket in the required position using M5 screws (the screws must be prepared by the user). Bracket thickness 2 mm, Recommended mounting screw is M5x8 mm).
- Align the grooves on the bar with the end brackets and slide them into place.
- When using intermediate brackets (for bar lengths of 680 mm or longer), install them so that the distance between them and the end brackets on both ends is the same.
- Make sure the bar is secured with the bracket.

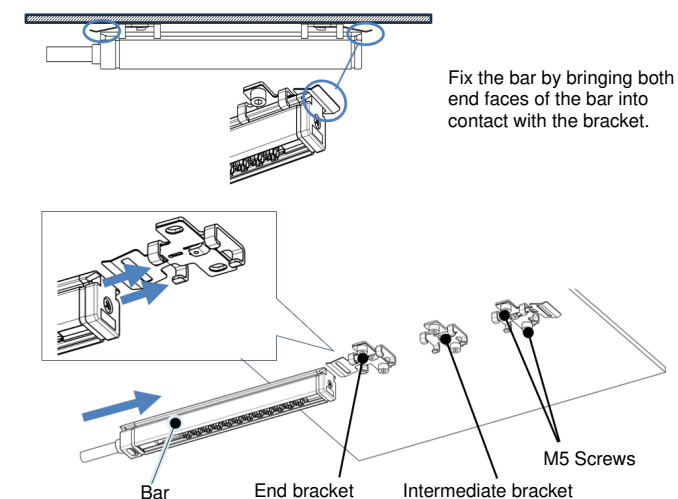

## 3.4 Connecting the controller to HV power supply for IZT45

- Remove the protective film on the controller before use.
- The product is used by connecting the controller and High Voltage power supply module. They can be connected either directly or separately. For separate connection, an optional separate cable is required.
- Mount a dust cover on the D-sub connector when not using the directly mounted high voltage power supply module.

## 1) Direct connection

- Fix the controller and high voltage power supply module using cross recessed round head screws (M4x30 mm) supplied. Recommended tightening torque: 0.22 to 0.24 N.m

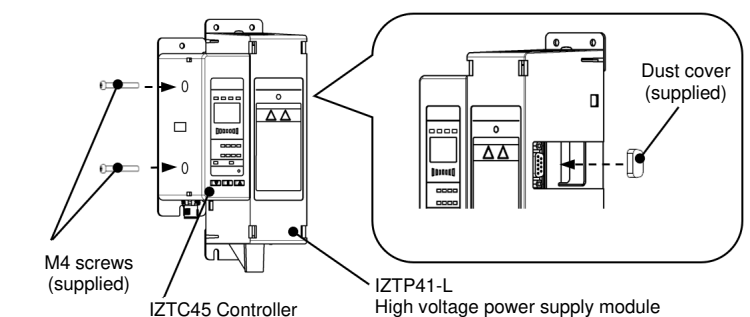

### 3 Installation (continued)

#### 2) Separate connection

- For separate connection, an optional separate cable is required.
  - Mount the spacers (supplied) to fix the separate cable to the high voltage power supply module.
  - Fix the spacers (2 pcs.) to the plug (male side) of the D-sub connector on the high voltage power supply module.
  - Connect the controller and high voltage power supply module after mounting the spacers and fix the connector using 2 round head combination screws (M2.6).
- Spacer tightening torque: 0.4 to 0.6 N.m  
Separate cable tightening torque: 0.25 to 0.35 N.m

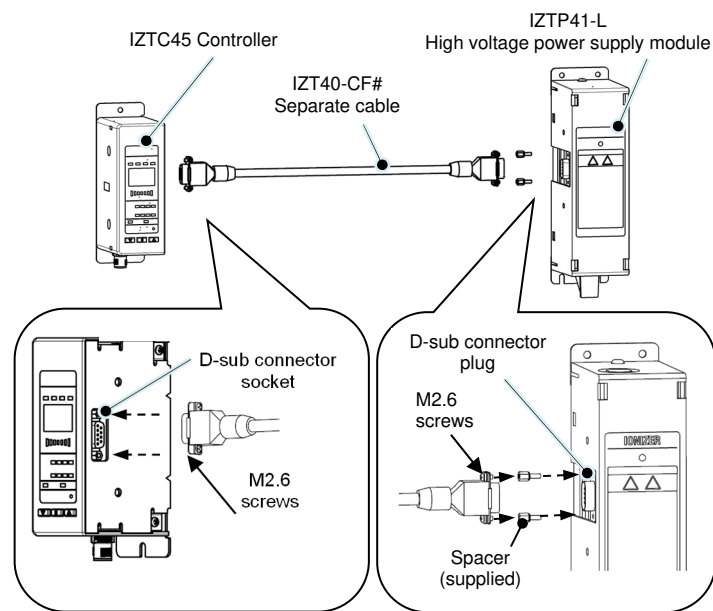

#### 3) Connecting multiple units.

- Up to 4 controllers and high voltage power supply modules can be connected together.
- When multiple controllers are connected, make sure that the displayed content and the number of connected controllers is consistent after power is supplied (Connected CH turns on or flashes).

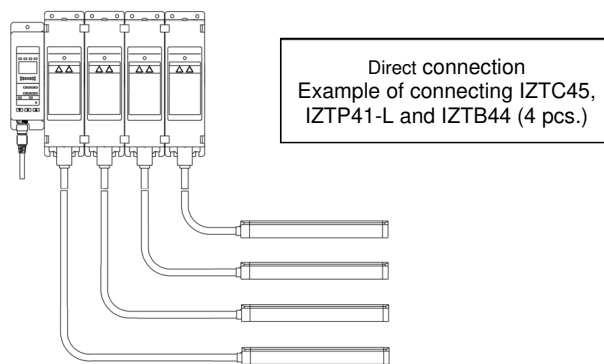

#### 3.5 Installing the controller and HV power supply for IZT45

Install the controller and High Voltage power supply module using screws or DIN rail mounting brackets.

##### 1) Mounting with screws (screws must be prepared by the user).

- Fix the controller (IZTC45) using 2 x M4 screws.
  - Fix the high voltage power supply module controller (IZTP41-L) using 4 x M4 screws.
  - The number of screws to connect multiple high voltage power supply modules = Number of connected modules x screws necessary for fixing a module.
- A) When the controller and high voltage power supply module are directly connected.  
Install the directly connected controller and high voltage power supply module at location B using M4 screws (screws must be prepared by the user).

### 3 Installation (continued)

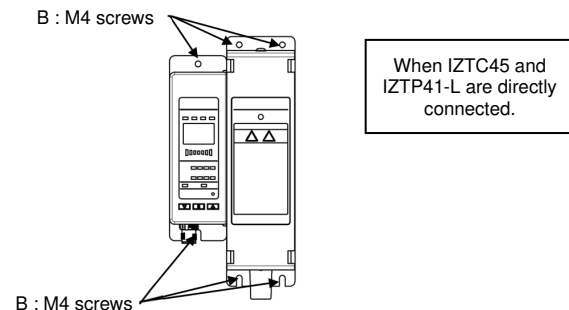

#### B) When the controller and high voltage power supply module are connected separately.

Mount the spacers to the high voltage power supply module. Install the separately connected controller and high voltage power supply module at location B using M4 screw (x 6). (screws must be prepared by the user).

#### C) Adding a high voltage power supply module

- The High voltage power supply module to be added should be connected by D-sub connector at location C.
- Mount the brackets to location D.
- Install the controller and high voltage power supply module. Fix the controller and high voltage power supply module at location B using M4 screws (screws must be prepared by the user).
- High voltage power supply module CH number setting.

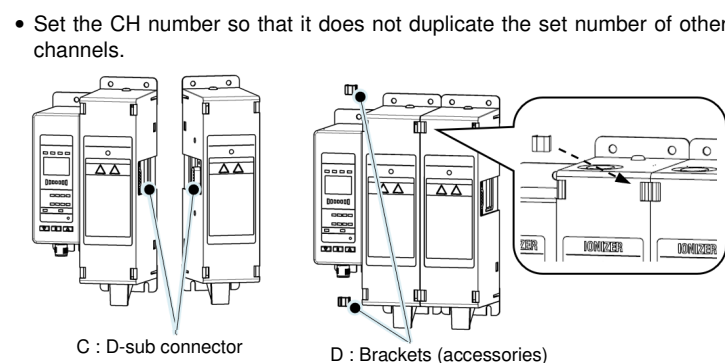

#### 2) Installation of DIN rail

- Use an optional DIN rail mounting bracket, required for mounting the controller and high voltage power supply module.
- Tighten the fixing brackets that are supplied to the specified torque before installation.

#### A) When the controller and high voltage power supply module are directly connected

- Remove the fixing bracket from the DIN rail mounting bracket at the adjoining faces indicated at location E.
  - DIN rail mounting bracket.
    - Fix the controller and high voltage power supply module to the DIN rail mounting bracket using M4 screws. Tightening torque: 1.30 to 1.50 N.m
  - Install to the DIN rail.
- After installing the DIN rail mounting bracket, fix the controller and high voltage power supply module to the DIN rail using M4 screws. Recommended tightening torque: 1.30 to 1.50 N.m

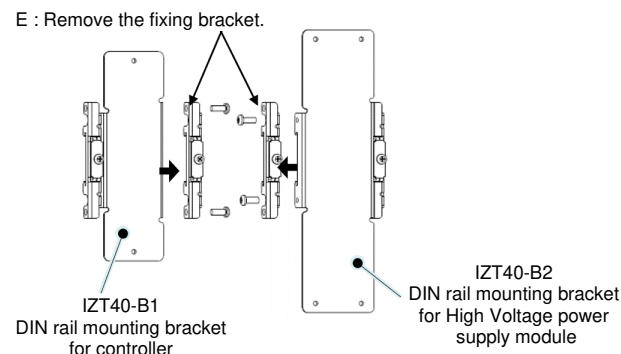

### 3 Installation (continued)

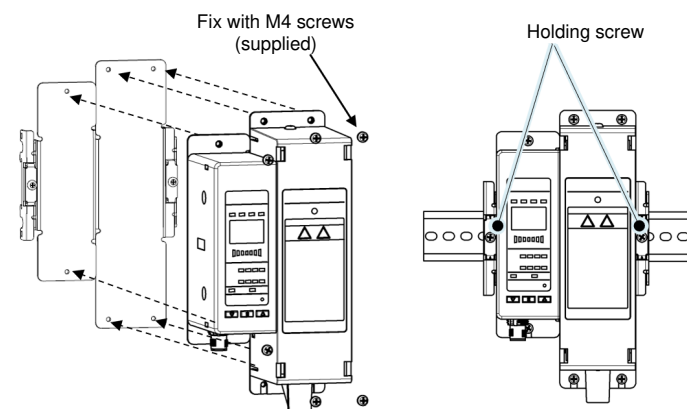

#### B) When the controller and high voltage power supply module are connected by separate cable

- Mount the spacers to the high voltage power supply module connector.
- a. DIN rail mounting bracket
- Fix the DIN rail mounting bracket to the controller and high voltage power supply module using M4 screws. Recommended tightening torque: 1.30 to 1.50 N.m.

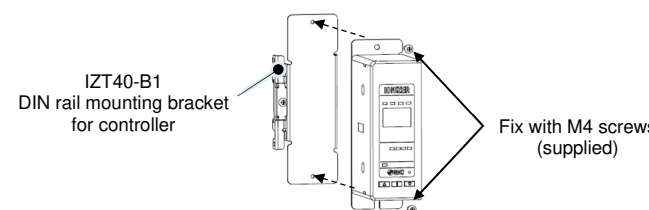

#### b. Mounting on the DIN rail.

- After installing the DIN rail mounting bracket, fix the controller and high voltage power supply module to the DIN rail using M4 screws. Recommended tightening torque: 1.30 to 1.50 N.m.

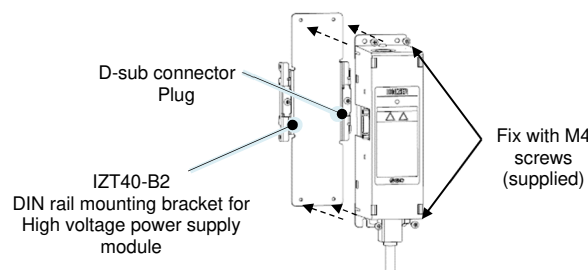

#### c. Connection of separate cable

- Mount the spacers (supplied) to fix the separate cable to the high voltage power supply module.
- Fix the spacers (2pcs.) to the plug (male side) of the D-sub connector with high voltage power supply module.
- Connect the controller and high voltage power supply module after mounting the spacers and fix them using M2.6 screws. Spacer tightening torque: 0.4 to 0.6 N.m. Separate cable tightening torque: 0.25 to 0.35 N.m.

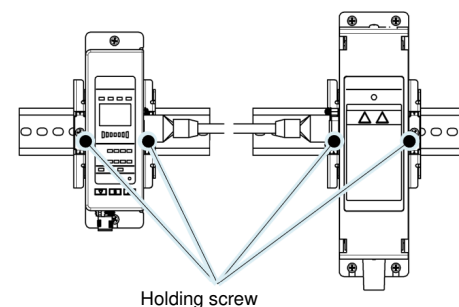

### 3 Installation (continued)

#### C) When the high voltage power supply module is added directly

- Removal of the fixing bracket.
  - Remove the fixing bracket from the DIN rail mounting bracket at the adjoining faces indicated at location E.

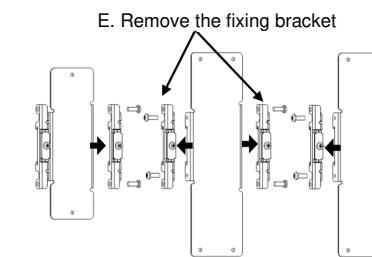

#### b. Mounting of DIN rail mounting bracket

- Fix the controller and high voltage power supply module to the DIN rail mounting bracket using M4 screws. Recommended tightening torque: 1.30 to 1.50 N.m.

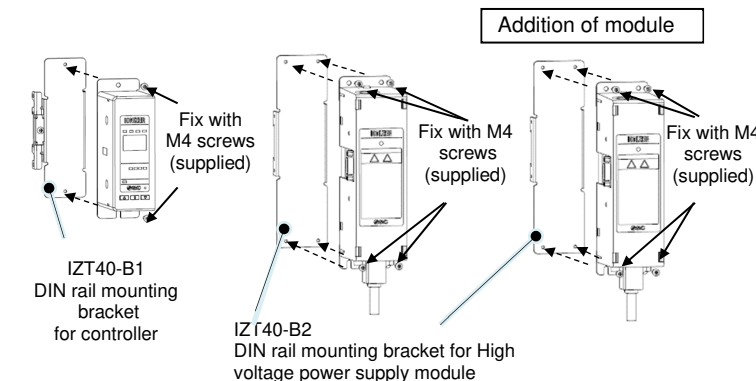

#### c. Connect the controller and high voltage power supply module

- Connect the D-sub connector in location C and fix the controller and high voltage module together using M4x30 screws (2 pcs. supplied). Recommended tightening torque: 0.22 to 0.24 N.m.

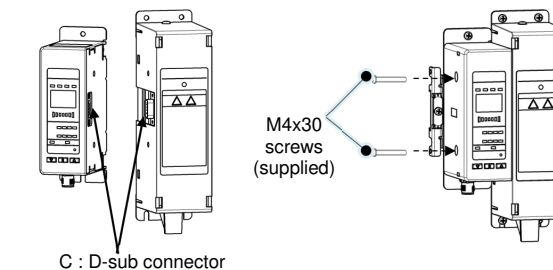

#### d. Install to DIN rail

- Mount them on to the DIN rail and connect the additional high voltage power supply module D-sub connector.

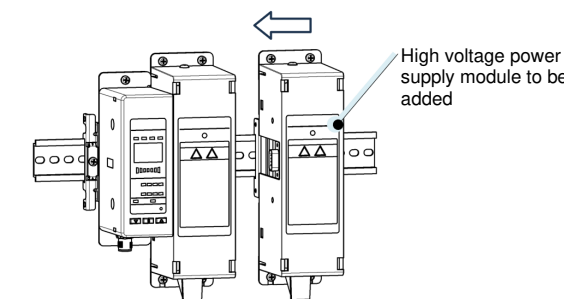

### 3 Installation (continued)

e. Mount the fixing bracket (supplied) in location D.

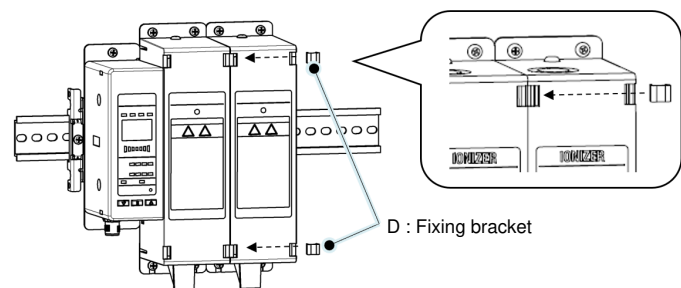

f. Fix to DIN rail.

After installing to the DIN rail, fix the controller and high voltage power supply module using set screws.

Recommended tightening torque: 1.30 to 1.50 N.m.

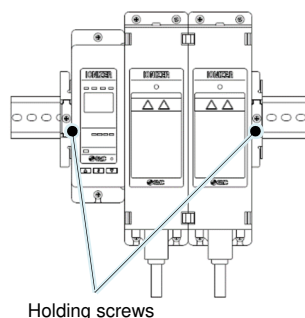

g. High voltage power supply module.

Set the CH number setting switch for all connected high voltage power supply modules.

- Set the CH number so that it does not duplicate the set number of other channels.

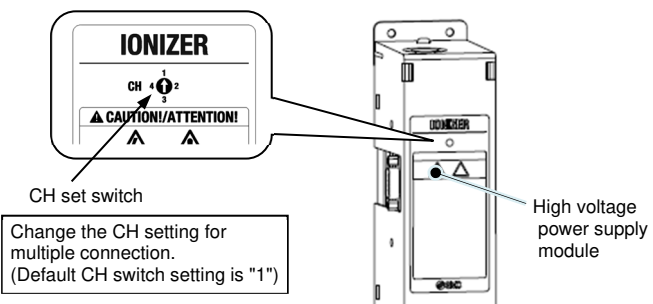

### 3.6 Installing the controller with HV power supply for IZT44

- The controller with high-voltage power supply can be installed with screws or on a DIN rail using DIN rail mounting brackets.

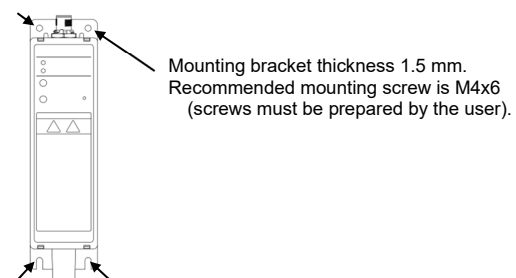

- Use an optional DIN rail mounting bracket.

After installing the DIN rail mounting bracket, fix the bracket to the DIN rail using screws. Recommended tightening torque: 1.30 to 1.50 N.m.

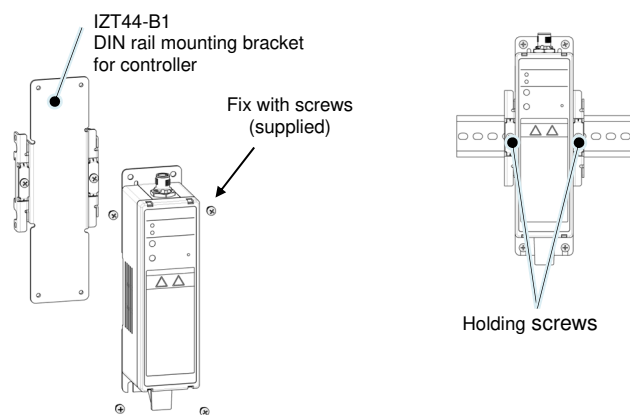

### 4 Wiring

#### 4.1 Routing of cables

- Do not apply excess stress to the mounting part of the connector.
- When the cable is bent, maintain the minimum bend radius.  
Minimum bending radius: Power supply cable: 40 mm  
Separate cable (optional): 40 mm  
High voltage cable: 30 mm

##### 1) Power supply cable

- The power supply cable supplies power to the product and external equipment used to control this product.
- When removing the power supply cable, pull it out straight. If mounted or removed in an inappropriate direction, the connector may be damaged and cause operation failure.
- Fix the cable around the connecting part so that stress is not applied to the connector.
- Connect the lead wires according to the wiring diagram. Unused wires should be cut short or insulated using insulation tape.
- For IZT45, to satisfy the current capacity, make sure to wire 2 brown cables in which a voltage of 24 VDC is supplied and 2 blue cables in which 0V is connected.

##### 2) Separate cable (optional for IZT45)

- Cable for connecting the controller and high voltage power supply module and connecting extension modules separately. This cable is not necessary when the modules are directly connected.
- Before connecting the cable, mount the spacers (supplied) in the male side of the D-sub connector plug on the high voltage power supply module. Connect the controller and high voltage power supply module.
- It is not necessary to mount spacers to the controller D-sub connector and the D-sub connector (socket) of the high voltage power supply module because spacers are already mounted to them.
- When the separate cable is mounted or removed, press the connector lever and insert or take out the plug straight. If mounted or removed in an inappropriate direction, the connector may be damaged and cause operation failure.
- After connecting the separate cable, fix the connector screws. Mount the

dust cover to any D-sub connector which is not used.

##### 3) High voltage cable

- Connect the high voltage cable connector to the IZT44/45 controller.
- When connecting and disconnecting the high voltage cable, hold the plugs together with the plug bodies, and insert or pull out straight. If mounted or removed in an inappropriate direction, the mounting part of the modular connector may be damaged and cause operation failure.
- Do not touch part A when handling the plug. Be careful so that moisture oil or foreign matter does not adhere to the plug. This may cause high voltage electric leakage. If anything adheres to part A, wipe it with ethanol.
- After connecting the high voltage cable to the controller, fix the cable using 2 cross recessed pan head screws (M4x10 mm) supplied. Recommended tightening torque: 0.49 to 0.53 N.m.

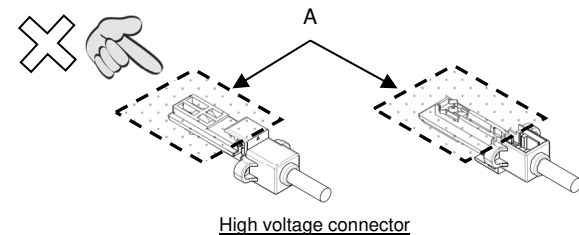
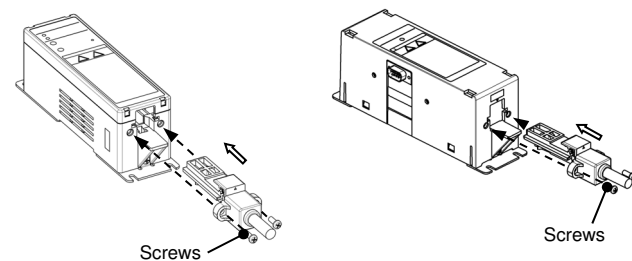

### 4 Wiring (continued)

- When installing the high voltage cable, use the specified high voltage cable holder.
- For installation of the High voltage cable holder (straight), use 2 cross recessed pan head screws (screws must be prepared by the user). Mounting bracket thickness 1.6 mm. Recommended mounting screw is cross recessed pan head screw M4x6 mm.
- For installation of the High voltage cable holder (elbow), use 3 cross recessed pan head screws (screws must be prepared by the user). Mounting bracket thickness 3.8 mm. Recommended mounting screw is cross recessed pan head screw M4x8 mm.
- When they are used in layers, select the screw length considering the thickness of the high voltage cable holder (14.8 mm / holder).
- When holding the high voltage cable to the cable holder, align the cable in the holding position and mount it by pressing the cable. Recommended tightening torque: 0.19 to 0.21 N.m.

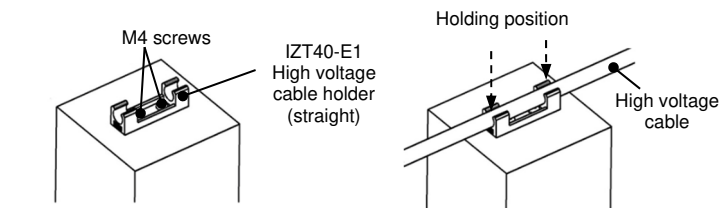

#### Installation example 1

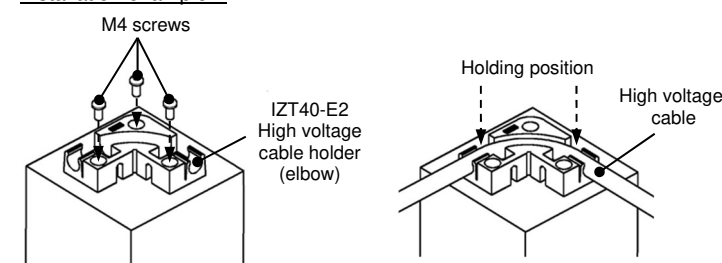

#### Installation example 2

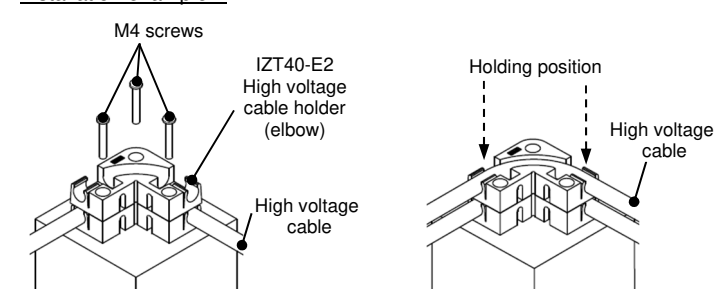

#### Installation example 3

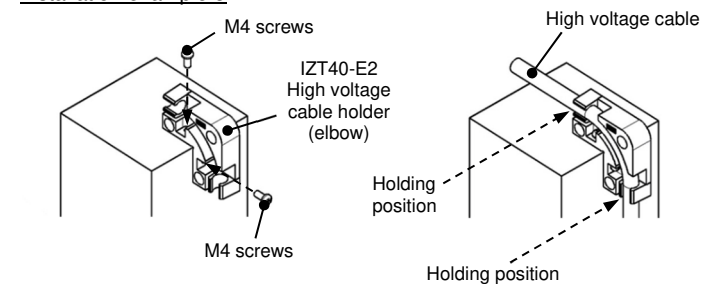

#### 4) Ionizer Bar branch wiring

- By using branch cables, two bars can be connected to one controller.

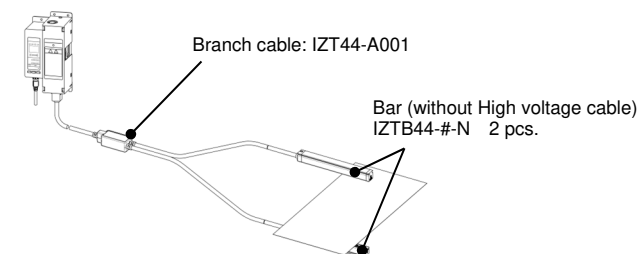

### 4 Wiring (continued)

Assembly procedure

(1) Insert the branch cable into each bar.

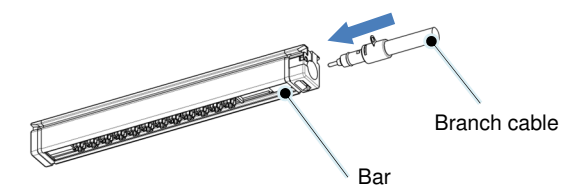

(2) Fasten using the clip and screw. Insert the clip firmly all the way to the bottom to prevent it from falling out.

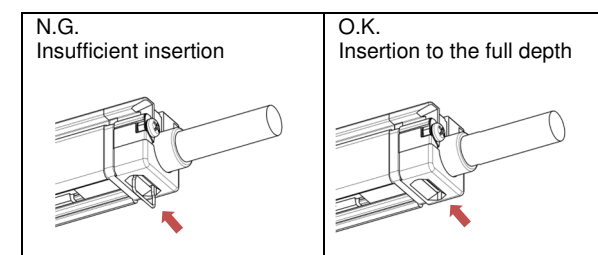
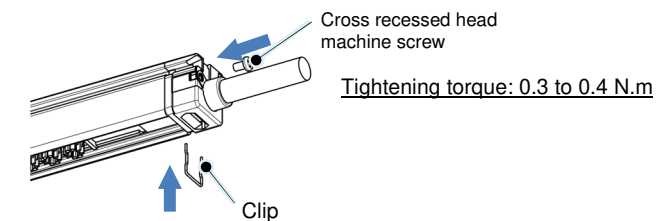

(3) Install the bar and insert the branch cable into the controller and fix it with screw.

#### 4.2 Electrical connection

- Wire power cables according to the wiring diagram and table.
- Do not apply excess stress to the mounting part of the controller connector.
- When the power supply cable is bent, maintain the minimum bend radius. Minimum bend radius: 40 mm
- Unused wires should be cut short or protected using insulation tape.
- For IZT45, to satisfy the current capacity, make sure to use 2 cables "brown and brown-white" in which a voltage of 24 VDC is supplied and 2 cables "blue and blue-white" in which 0 V is connected.

#### Warning

- Before wiring, ensure that the power supply capacity meets the specification and that the voltage is within the specification. Product damage or malfunction can result.
- To maintain product performance, the power supply should be UL Class 2 certified by National Electric Code (NEC) or evaluated as a limited power source according to UL60950.
- To maintain the product performance, ground the product with an earth ground cable with a resistance of 100 Ω or less. If the product is not grounded, it is not possible to secure the performance and may lead to product failure or malfunction.
- Wiring (including insertion and removal of the power supply connector) should never be carried out with the power supply ON. Otherwise, an electrical shock or accident may occur.
- Use the specified cable for connecting the controller, High voltage power supply module and bar for this product. Do not disassemble or retrofit them. Disassembling or modifying the product may cause a failure. The product will not be guaranteed if it is disassembled and/or modified.
- Ensure the safety of wiring and surrounding conditions before supplying power.
- Do not connect or disconnect the connectors (including power source) while the power is ON. Failure to follow this procedure may cause product malfunction.
- If the power and high voltage cables are routed together, the product may malfunction due to noise. Route the ionizer wires separately.
- Confirm that the wiring is correct before operation. Incorrect wiring will lead to product damage or malfunction.

**4 Wiring (continued)**

**4.2.1 Ground the F.G. cable**

- Make sure to ground the F.G. cable with a resistance of 100 Ω max.
- The F.G. cable is used as a reference electric potential for static neutralization (Functional earth). If the F.G. cable is not grounded, an optimal ion balance cannot be obtained, and it may damage the product and power supply.

**4.2.2 Grounding at DC mode**

- When an ionizer is used in DC mode, make sure to ground the F.G. cable (green) and DC(-) cable (blue) of the input power supply with a resistance of 100 Ω max. Without grounding the DC(-) cable, the ionizers and/or power supply may be damaged.

1) Wiring of IZT44

Wire colour	Signal	Description
Brown	DC(+)	Connect power supply to operate the ionizer.
Blue	DC(-)	
Green	F.G.	Frame ground.
Black	COM	Common terminal for error signal. NPN output: Connected to 0V (Negative common) PNP output: Connected to DC+24V (Positive common)
White	OUT (B contact)	Error signal. OFF when there is a problem.

**NPN**

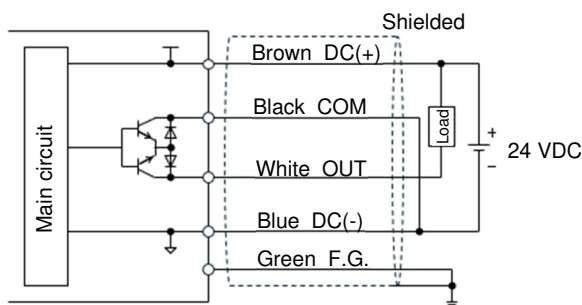

**PNP**

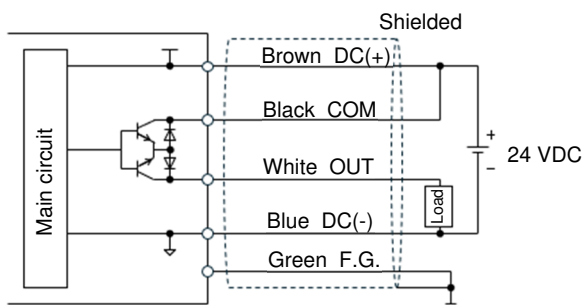

2) Wiring of IZT45

Wire colour	Signal	Description
Brown	DC(+)	Connect power supply to operate the ionizer.
Brown-White		
Blue	DC(-)	
Blue-White		
Green	F.G.	Frame ground.
Yellow	IN	Signal input to turn ON/OFF ion generation.
Black	OUT1 (A contact)	Maintenance detection signal. Turns ON when emitter needs cleaning.
White	OUT2 (B contact)	Error signal. Turns OFF when there is problem.

**4 Wiring (continued)**

**NPN**

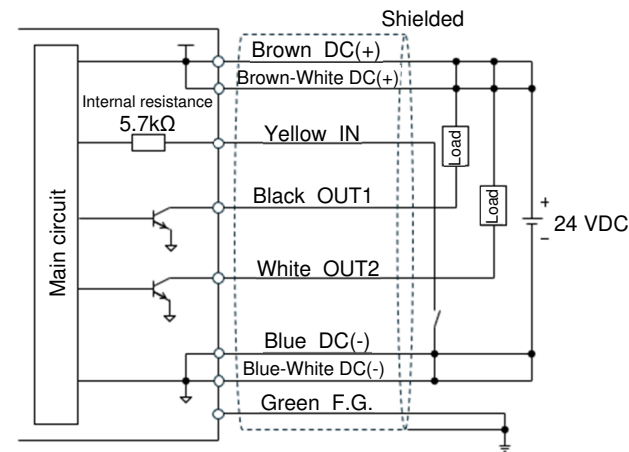

**PNP**

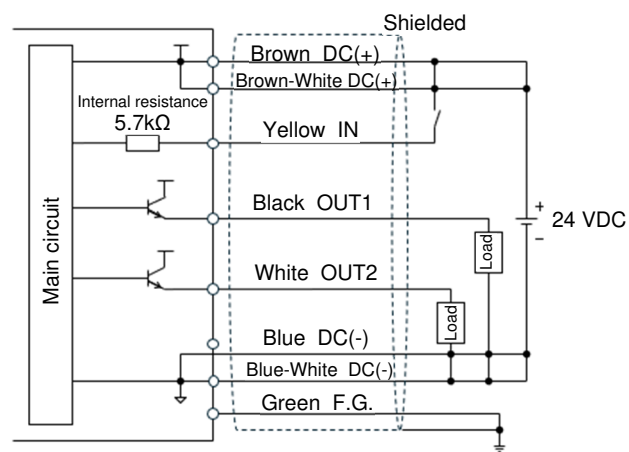

3) Connection of the AC adapter

- Perform F.G. wiring with the ground terminal (F.G.) of AC cord when the AC adapter is used. If the AC cord is plugged in, plug it into a grounded outlets with less than 100Ω. Use an AC cord with ground terminal, if it is prepared by the user.
- The ground terminal (F.G.) is used as a reference electric potential for static neutralization. If the ground terminal is not grounded, the ionizer will not be able to achieve the optimal offset voltage (ion balance).
- When an AC adapter is used, the input/output signal cannot be used.

**5 Name and Function of parts**

**5.1 Controller**

1) IZTC44

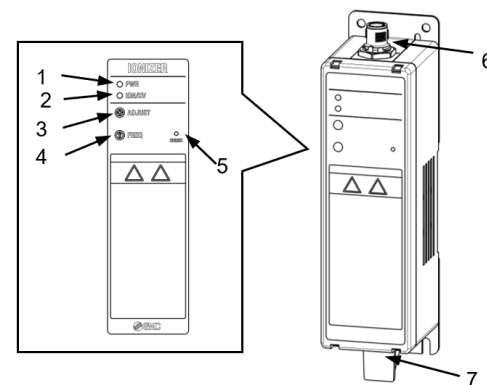

**5 Name and Function of parts (continued)**

No.	Name	Indication	Type	Description
1	Power supply LED	PWR	LED (Green)	ON during operation. Flashes in case of abnormality.
2	Ion emission / high voltage error LED	ION/HV	LED (Green / Red / Orange)	ON during static neutralization, ON red or flashing red in case of abnormality. Flashing orange during output check.
3	Offset voltage adjustment trimmer	ADJUST	Trimmer	Used to set offset voltage adjustment.
4	Frequency set switch	FREQ	Rotary switch	Used to set ion generating frequency.
5	CHECK button	CHECK	Push button	Outputs a signal for confirmation.
6	Power supply connector	-	M12 Connector	Connect the power cable.
7	High voltage cable connector	-	Connector	Connects to the High voltage cable of the bar.

2) IZTC45

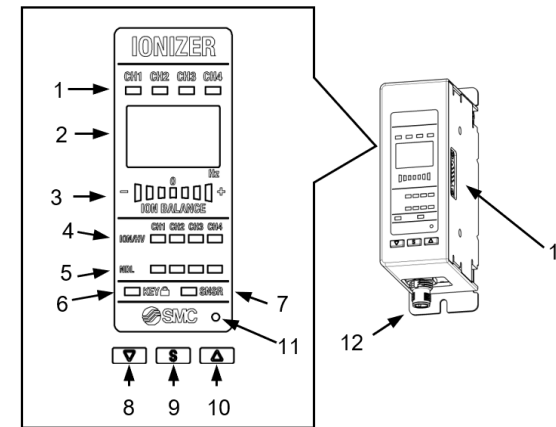

No.	Name	Indication	Type	Description
1	CH display	CH□	LED (Green)	LED of CH connected to the controller is ON (green), LED of the selected CH flashes (green).
2	Frequency display	Hz	LED (Green)	LED (green) is ON during operation. LED flashes (green) during setting and each abnormality.
3	Ion balance display	ION BALANCE	LED (Green / Orange)	LED (green) indicates the balance status by lighting up during operation. LED (green) flashes during offset voltage adjustment. LED (orange) flashes when ion balance is maximum or minimum during offset adjustment.
4	Ion emission/High voltage error display	ION/HV	LED (Green / Red)	LED (green) is ON during static neutralization. LED (red) is ON or flashes when abnormality exists.
5	Maintenance display	NDL	LED (Green)	LED (green) is ON when emitter contamination is detected.
6	Key-lock display	KEY	LED (Green)	LED (green) is ON when Key lock is ON.
7	Sensor LED	SNSR	LED (Green)	LED (green) is ON when Auto balance function is ON.
8	▼ button	-	Push button	Decrease the set value.
9	S button	-	Push button	Change the mode and set a set value.
10	▲ button	-	Push button	Increase the set value.
11	Reset button	-	Push button	Return the setting values of each mode to the default condition.
12	Power supply connector	-	M12 Connector	Connect the power cable.
13	High voltage power supply	-	D-sub	Connect high voltage power supply module or separate cable.

**5 Name and Function of parts (continued)**

**5.2 High voltage power supply module**

1) IZTP41-L

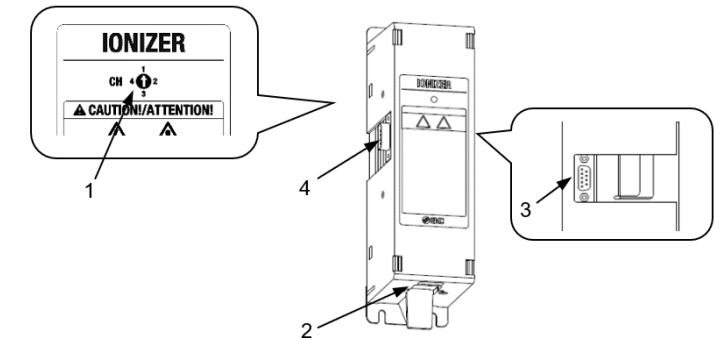

No.	Name	Panel indication	Type	Description
1	CH number set switch	CH	Rotary switch	• High voltage power supply module CH number setting.
2	High voltage cable connector	-	Connector	• Connect with the high voltage cable of the bar/nozzle.
3	High voltage power supply module connector	-	D-sub Connector (socket)	• Connect high voltage power supply module or separate cable.
4	Controller/High voltage power supply module connector	-	D-sub connector (plug)	• Connect the controller, high voltage power supply module or separate cable.

**6 Setting**

**6.1 Operation Flow chart**

**IZT44**

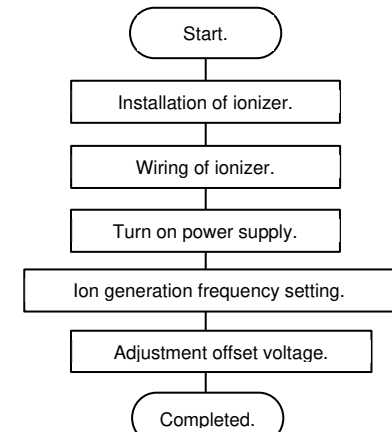

**IZT45**

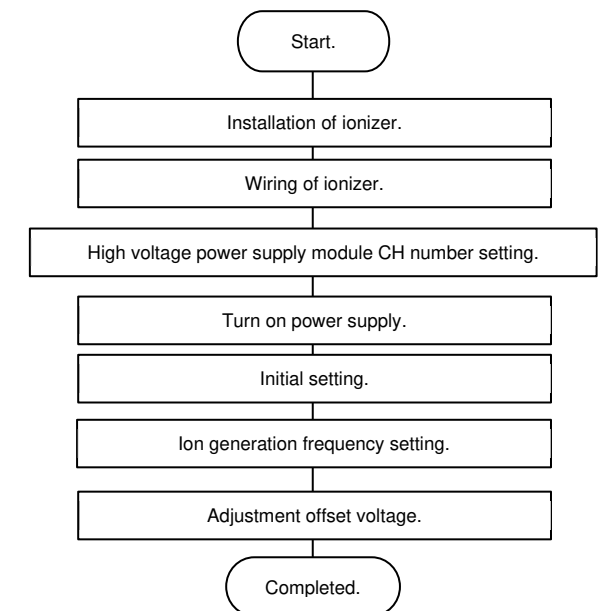

## 6 Setting (continued)

### 6.2 Initial setting for IZT45

#### 6.2.1 Selection of NPN / PNP input and output

- The input/output specification (NPN/PNP) of the external signals can be selected by controller operation.
- When the reset button is pressed for 3 seconds or longer in the factory default or during use, "10" is displayed in the frequency display section.
- When "10" is displayed, press the ▼ or ▲ button to select NPN or PNP specification. After selecting NPN or PNP, press the S button to go to the initial setting for maintenance detection if the product is operated for the first time from the factory, or to the CH selection mode if done from the reset button, and save the set specification.
- The settings saved here will be maintained until the reset button is pressed.

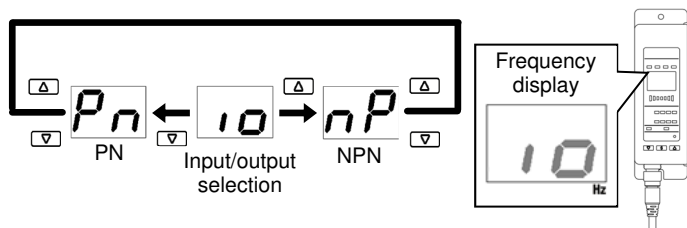

[Selecting the input/output is necessary in following cases]

- When "10" is displayed in the frequency display area.
- When the input/output specification of the device used has been changed.

\*Press and hold the Reset button and confirm that "10" is displayed in the frequency display section before making settings.

#### 6.2.2 Maintenance detection initialization

- This product has a function which constantly monitors the emitter contamination. When the emitter contamination is detected, it is indicated by a signal output and LED. Initial setting is necessary for maintenance detection.

- If the product is operated for the first time from the factory, after setting the input/output specifications, "10" is displayed in the frequency display. Select a bar for initialization, and press and hold the S button for more than 3 seconds to start initialization.
- If the Reset button is pressed during normal operation, "10" is displayed in the frequency display and the module is initialized. If the S button is pressed and held for more than 3 seconds, the initialization of the selected CH of bar is started. Connect and install the ionizer bar to be used before setting.
- When multiple bars are connected, assign the channel for which initial setting is necessary.
- Do not disconnect the power supply during setting (Initial setting is completed within 60 seconds).

[Initial setting is necessary in the following cases]

- When "10" is displayed in the frequency display.
- Bar is replaced.
- Installation environment is changed.

\*For 2) and 3), perform the initial setting after pressing the reset button and make sure that "10" is displayed in the frequency display. It is recommended to start the initial setting for 3) after replacing the bar. If initial setting is performed while the emitter cartridge is not clean or is worn out, maintenance detection may not operate correctly.

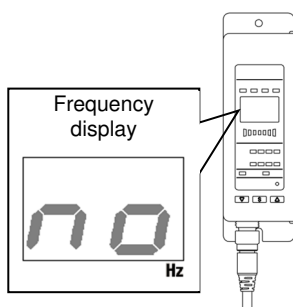

## 6 Setting (continued)

### 6.3 High voltage power supply module CH number setting for IZT45

- When multiple high voltage power supply modules are connected to one controller, the CH number must be set for each high voltage power supply module to identify the information and set time.
- The CH number can be assigned from 1 to 4 (up to 4 modules can be connected). Set the CH number using the rotary switch on the high voltage power supply module.
- The CH number set for the high voltage power supply module corresponds to the CH number displayed on the controller.
- When multiple high voltage power supply modules are used (max 4 pcs.) the CH number must not be duplicated. Duplication of the CH number will generated an error (error code: E<sup>1</sup>).

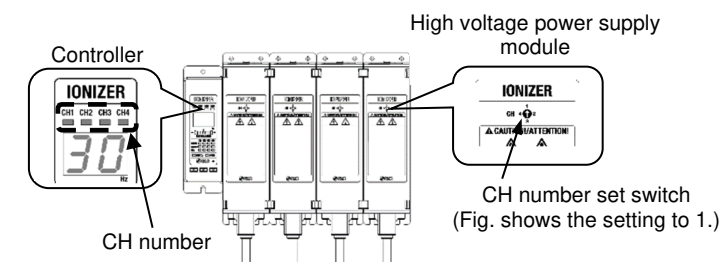

### 6.4 Controller setting

#### 1) Setting IZT44

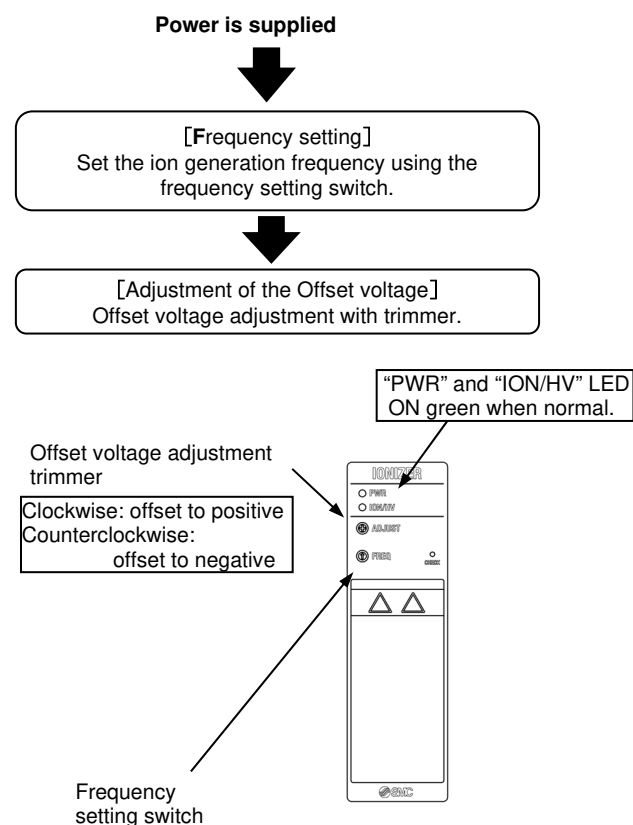

No.	Ion generation frequency [Hz]
0	1
1	3
2	5
3	8
4	10
5	15
6	20
7	30
8	DC +
9	DC -

## 6 Setting (continued)

### 2) Setting IZT45

(Default condition)  
 Frequency setting: 30Hz  
 Key lock: OFF  
 Built-in sensor: OFF  
 Emitter contamination: MIDDLE

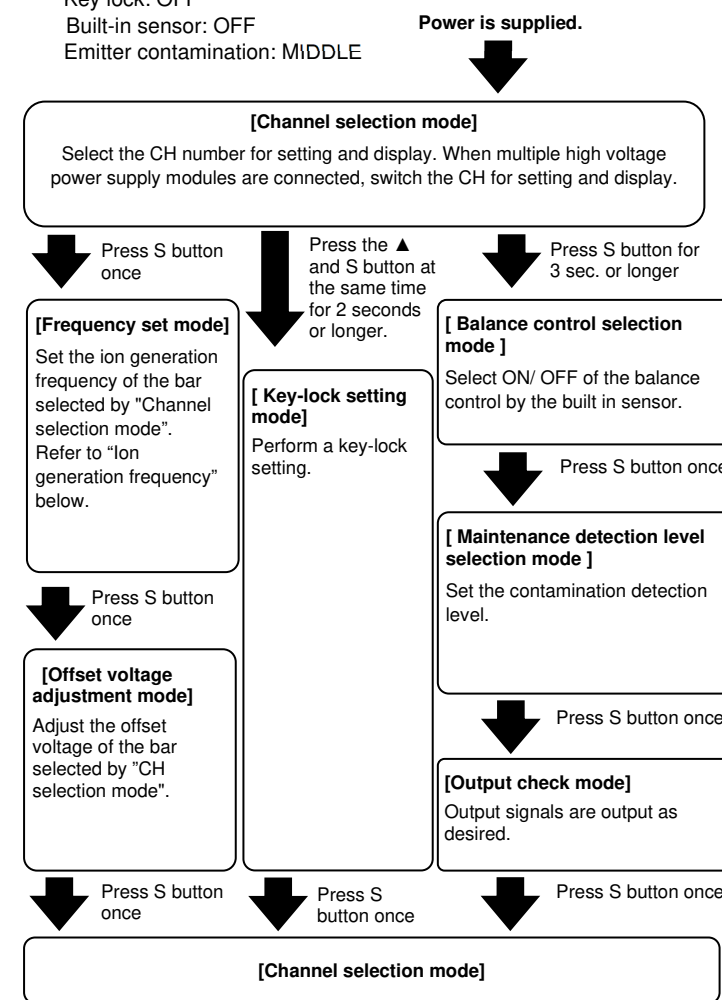

Note) In each setting mode, the selected bar moves on to the ion generation stop mode by pressing ▼ and ▲ button simultaneously for 2 s or longer and stops the ion generation (Operation is not possible while the key lock is ON or externally input signal is ON). To release, press the S button once or turn the power off and on again.

Ion generation frequency [Hz]
1
3
5
8
10
15
20
30
DC +
DC -

Ion generation frequency

## 7 How to Order

Refer to drawings or catalogue for 'How to Order'.

## 8 Outline Dimensions

Refer to drawings or catalogue for outline dimensions.

## 9 Maintenance

### 9.1 General Maintenance

#### Caution

- Not following proper maintenance procedures could cause the product to malfunction and lead to equipment damage.
- Before performing maintenance, turn off the power supply.
- If any electrical connections are disturbed during maintenance, ensure they are reconnected correctly and safety checks are carried out as required to ensure continued compliance with applicable national regulations.
- Do not make any modification to the product.
- Do not disassemble the product, unless required by installation or maintenance instructions.

### 9.2 Maintenance

- If this product is used for an extended period of time, contamination such as dust will stick to the emitters,
- reducing the static neutralization performance.
- The IZT45 is equipped with a maintenance detection function, so clean the emitter when it detects contamination.
- If the maintenance detection function is not used in the IZT45 or if the IZT44 is used, perform a neutralizing performance test and set a maintenance cycle for periodic cleaning.
- The emitter contamination and maintenance detection time is different depending on the installation environment, etc.
- If the maintenance LED is ON upon completion of cleaning the emitter, it may not have been cleaned sufficiently or it may be worn or damaged. If the emitters are worn out or damaged, replace the bar.
- If the emitter is worn out or damaged, the static electricity elimination performance will decrease.

#### Warning

- Perform maintenance regularly and clean the emitters.
- Be sure to remove power supply to the controller bar before cleaning the emitter or replacing the bar.
- Do not disassemble or modify the product.

- Do not operate the product with wet hands.
- This product contains a high voltage generation circuit. When performing maintenance inspection, be sure to confirm that the power supply to the ionizer is turned off.
- Never disassemble or modify the product, as this can cause loss of product functionality, and there is also a risk of electric shock and earth leakage.
- Do not touch the end of the emitters. They have a sharp end and touching them directly with your fingers may cause injury.
- Only people who have sufficient knowledge are allowed to clean the emitters.

#### Cleaning procedure of emitter

- It is highly recommended that the emitter cleaning kit (IZT44-M3) is used to clean the emitter needles.
  - Before cleaning the emitters, turn off the power supply.
  - Place the cleaning kit on the bar so that the brush touches the emitter and move it along the groove to clean it.

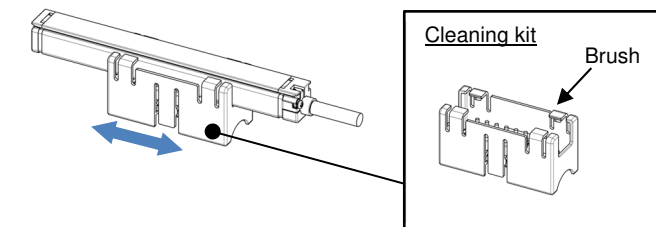

- If you do not have a cleaning kit, an alcohol saturated cotton ball can be used for cleaning the electrodes. Use caution to prevent damage to the electrode needles.
- The alcohol used should be reagent ethanol class 1 99.5 vol% or more.

## 9 Maintenance (continued)

### Bar Replacement

- If ionization is still not possible after cleaning the emitter, the emitter may be worn or damaged. If this is the case, replace the bar according to the following procedure.

- Raise the lever on the end bracket.



- Slide the bar out.

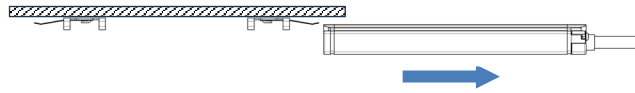

- Remove the clip and the cross-holed small screw from the bar.

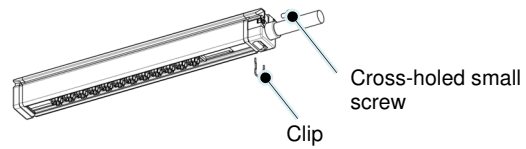

- Disconnect the high voltage cable.

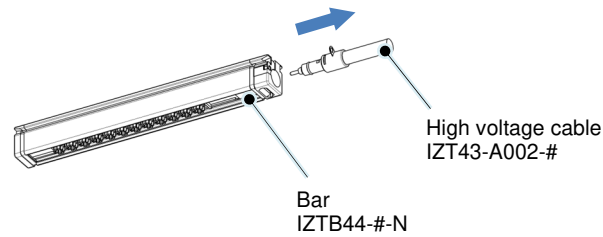

- For installation, reverse the above steps.
- Tightening torque for small screws with cross holes during installation 0.3 to 0.4 N.m
- Insert the clip firmly all the way to the back to prevent it from falling out.

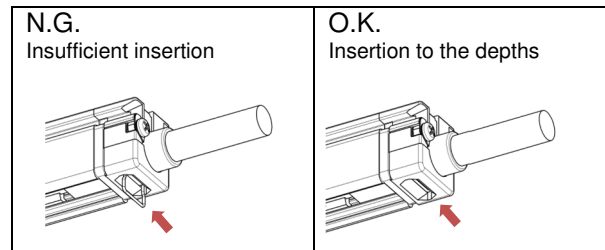

## 10 Limitations of Use

### 10.1 Limited warranty and disclaimer/compliance requirements

- Refer to Handling Precautions for SMC Products.

#### Caution

- Do not apply excessive external force or shock (100m/s<sup>2</sup> or more) to the product. Even if there are no problems with the appearance of the controller, High-voltage power supply module or bar, the damage of the internal components may cause malfunction.
- Hold the ends and the middle of the bar so that moment load is not applied. Handling the product by holding either end of the bar may cause deformation or damage to the product.
- Power cable must be connected and disconnected by hand. Open and close too much may damage the drain cock. Hold the connector by hand and straightly pull it out.
- If smoking, fire or smell occurs in the product, immediately shut off the power supply.
- Do not touch the A part of the high voltage connector in figure shown in "3.7 Routing of cables" by hand. Be careful so that moisture or foreign matter does not adhere to the connector. If moisture, oil, or foreign matter adheres to the A part, wipe it with ethanol.

## 11 Product disposal

- This product shall not be disposed of as municipal waste. Check your local regulations and guidelines to dispose of this product correctly, in order to reduce the impact on human health and the environment.

## 12 Contacts

Refer to [www.smcworld.com](http://www.smcworld.com) or [www.smc.eu](http://www.smc.eu) for your local distributor/importer.

## SMC Corporation

URL : <https://www.smcworld.com> (Global) <https://www.smc.eu> (Europe)  
SMC Corporation, 4-14-1, Sotokanda, Chiyoda-ku, Tokyo 101-0021, Japan  
Specifications are subject to change without prior notice from the manufacturer.  
© SMC Corporation All Rights Reserved.  
Template DKP50047-F-085N