

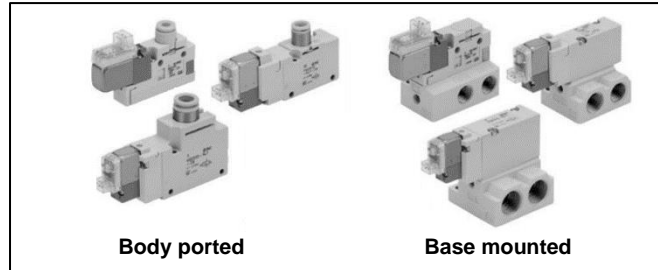

Instruction Manual
3 Port Solenoid Valve
Series VQZ100/200/300-1



The intended use of this product is to control the movement of an actuator.

1 Safety Instructions

These safety instructions are intended to prevent hazardous situations and/or equipment damage. These instructions indicate the level of potential hazard with the labels of "Caution," "Warning" or "Danger." They are all important notes for safety and must be followed in addition to International Standards (ISO/IEC¹⁾, and other safety regulations.

- ¹⁾ ISO 4414: Pneumatic fluid power - General rules relating to systems.
- ISO 4413: Hydraulic fluid power - General rules relating to systems.
- IEC 60204-1: Safety of machinery - Electrical equipment of machines. (Part 1: General requirements)
- ISO 10218-1: Robots and robotic devices - Safety requirements for industrial robots - Part 1: Robots.
- Refer to product catalogue, Operation Manual and Handling Precautions for SMC Products for additional information.
- Keep this manual in a safe place for future reference.

Caution	Caution indicates a hazard with a low level of risk which, if not avoided, could result in minor or moderate injury.
Warning	Warning indicates a hazard with a medium level of risk which, if not avoided, could result in death or serious injury.
Danger	Danger indicates a hazard with a high level of risk which, if not avoided, will result in death or serious injury.

Warning

- Always ensure compliance with relevant safety laws and standards.
- All work must be carried out in a safe manner by a qualified person in compliance with applicable national regulations.
- If this equipment is used in a manner not specified by the manufacturer, the protection provided by the equipment may be impaired.

Caution

- The product is provided for use in manufacturing industries only. Do not use in residential premises.

2 Specifications

2.1 Valve specifications

Series	VQZ100	VQZ200/300	
Valve construction	Poppet seal	Metal seal	Rubber seal
Fluid	Air		
Internal pilot operating pressure range [MPa] ^{Note 1)}	0.15 to 0.7	0.1 to 0.7	0.15 to 0.7
External pilot operating pressure range [MPa] ^{Note 1, 2)}	Operating pressure range	-100 kPa to 0.7	
	Pilot pressure range	0.2 to 0.7	0.1 to 0.7
Ambient and fluid temperature [°C]	-10 to 50 (No freezing)		
Minimum operating frequency	1 cycle / 30 days		
Maximum operating frequency [Hz]	20	5	
Pilot exhaust method	Common exhaust ^{Note 3)}	Individual exhaust	
Response Time	Refer to catalogue		
Flow rate	Refer to catalogue		
Lubrication	Not required (See 3.4)		

2 Specifications - continued

Series	VQZ100	VQZ200/300
Manual override	Push type, Locking type (Tool required)	
Duty cycle	Contact SMC	
Mounting orientation	Free	
Impact / Vibration resistance [m/s ²] ^{Note 4)}	150 / 30	
Enclosure (based on IEC60529)	IP40 equivalent (DIN terminal: IP65 ^{Note 5)}	
Weight	Refer to catalogue	

Table 1.

- Note 1) In case of the high pressure type, upper limit of max. operating pressure and external pilot pressure range is 1 MPa.
- Note 2) For VQZ100, when using the valve for a vacuum application, vacuum air through 1(P) port. When supplying vacuum-release air, supply it through 3(R) port. The release pressure must be set at 50% of external pilot pressure or less. When the VQZ100 operating pressure is greater than 0.2 MPa ensure that the external pilot pressure is greater than or equal to the operating pressure.
- Note 3) When using body ported type as a single unit, individual exhaust is used.
- Note 4) **Impact resistance:** No malfunction occurred when it is tested with a drop tester in the axial direction and at the right angles to the main valve and armature in both energized and de-energized states once for each condition. (Values quoted are for a new valve).
- Vibration resistance:** No malfunction occurred in one sweep test between 45 and 2000 Hz. Test was performed to axis and right-angle directions of the main valve and armature when pilot signal is ON and OFF. (Values quoted are for a new valve).
- Note 5) When IP65 compliant DIN terminals are selected.

2.2 Solenoid specifications

Electrical entry	Grommet(G), L type plug connector (L), M type plug connector (M), DIN terminal (Y)	
	G, L, M	Y
Coil rated voltage [V]	DC 24, 12 AC [50/60 Hz] 100, 110, 200, 220	
Coil insulation class	Contact SMC	
Allowable voltage fluctuation ^{Note 3)}	±10% of rated voltage ^{Note 2)}	
Power consumption [W]	Standard	0.35 (With indicator light: 0.4)
	High pressure type	0.9 (With indicator light: 0.95)

Apparent voltage [VA] ^{Note 1)}	AC	100V	110V	115V	200V	220V	230V
		0.78 (With light: 0.81)	0.86 (With light: 0.89)	0.94 (With light: 0.97)	1.18 (With light: 1.22)	1.3 (With light: 1.34)	1.42 (With light: 1.46)

Table 2.

- Note 1) Common solenoid between 110 VAC and 115 VAC, and between 220 VAC and 230 VAC.
- Note 2) For 115 VAC and 230 VAC, the allowable voltage is -15% to +5% of rated voltage.
- Note 3) Valve state is not defined if electrical input is outside of specified operating ranges.

2.3 Manifold specifications

Series	VQZ100	VQZ200	VQZ300
Max. number of stations	20		
Port size	1(P), 3(R)	Rc1/8	
	2(A)	C3, C4, C6 M5	C4, C6 M5

Table 3.

2.4 Pneumatic symbols

Refer to catalogue for Pneumatic symbols.

2.5 Indicator light

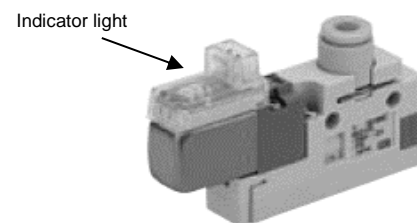

Figure 1.

2 Specifications - continued

2.6 Construction

Refer to catalogue for N.C type valve and see figure below for N.O. type. Description and material of component parts are the same for N.C. and N.O. types.

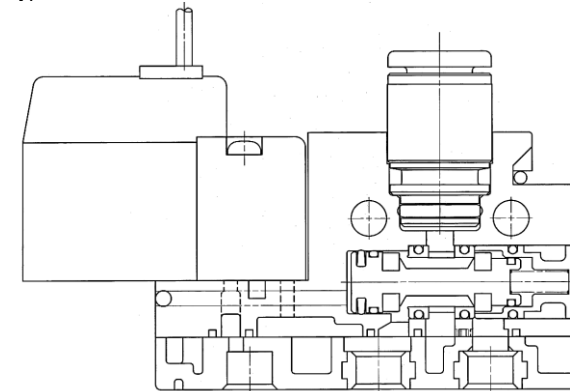

Figure 2. VQZ125 N.O. type

2.7 Special products

Warning

Special products (-X) might have specifications different from those shown in this section. Contact SMC for specific drawings.

3 Installation

3.1 Installation

Warning

- Do not install the product unless the safety instructions have been read and understood.

3.2 Environment

Warning

- Do not use in an environment where corrosive gases, chemicals, salt water or steam are present.

- Do not use in an explosive atmosphere.
- Do not expose to direct sunlight. Use a suitable protective cover.
- Do not install in a location subject to vibration or impact in excess of the product's specifications.
- Do not mount in a location exposed to radiant heat that would result in temperatures in excess of the product's specifications.
- Products compliant with IP65 enclosures are protected against dust and water, however, these products cannot be used in water.
- Products compliant with IP65 enclosures satisfy the specifications by mounting each product properly. Be sure to read the Specific Product Precautions for each product.
- Do not use in high humidity environment where condensation can occur.
- Contact SMC for altitude limitations.

3.3 Piping

Caution

- Before connecting piping make sure to clean up chips, cutting oil, dust etc.
- When installing piping or fittings, ensure sealant material does not enter inside the port. When using seal tape, leave 1 thread exposed on the end of the pipe/fitting.
- Tighten fittings to the specified tightening torque.

Connection thread size [R, NPT]	Tightening Torque [N·m]
1/8	3 to 5
M5	1 to 1.5

Table 4.

3.4 Lubrication

Caution

- SMC products have been lubricated for life at manufacture, and do not require lubrication in service.
- If a lubricant is used in the system, refer to catalogue for details.

3 Installation - continued

3.5 Air supply

Warning

- Use clean air. If the compressed air supply includes chemicals, synthetic materials (including organic solvents), salinity, corrosive gas etc., it can lead to damage or malfunction.

Caution

- Install an air filter upstream of the valve. Select an air filter with a filtration size of 5 µm or smaller.

3.6 Manual override

Warning

- Regardless of an electric signal for the valve, the manual override is used for switching the main valve. Connected actuator is started by manual operation. Only use the manual override after confirming that there is no danger.
- Locked manual overrides might prevent the valve responding to being electrically de-energised or cause unexpected movement in the equipment.
- Refer to the catalogue for details of manual override operation.

Caution

- Do not apply excessive torque when turning the locking type. (0.1 N·m or less).

3.7 Mounting

Caution

3.7.1 Valve mounting

- Ensure gaskets are in good condition, not deformed and are dust and debris free.
- When mounting valves ensure gaskets are present, aligned and securely in place and tighten screws to a torque as per table below.

Model	Proper tightening torque [N·m]
VQZ100	0.13 to 0.19
VQZ200	0.25 to 0.35
VQZ300	0.5 to 0.7

Table 5.

3.7.2 DIN rail and valve mounting / removal

Caution

Removing

- Loosen the clamp screws on the Ⓐ side of both ends of the manifold.
- Lift the Ⓐ side ⇒ of the manifold off the DIN rail and slide it in the direction of the Ⓑ side.

Mounting

- Catch the hook of the DIN rail bracket on the Ⓑ side on the DIN rail.
- Push Ⓐ side onto the DIN rail and tighten the clamp screw. The recommended tightening torque for screws is 0.3 to 0.4 N·m.

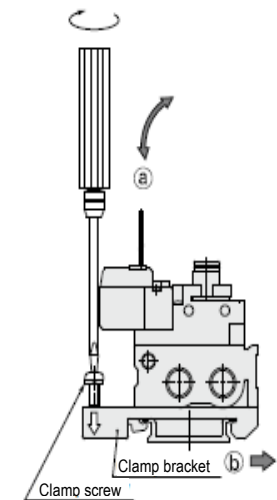

Figure 3.

3.8 Light/surge voltage suppressor

Caution

- If a valve type without suppression is used, suppression should be provided as close as possible to the valve by the host controller.

3 Installation - continued

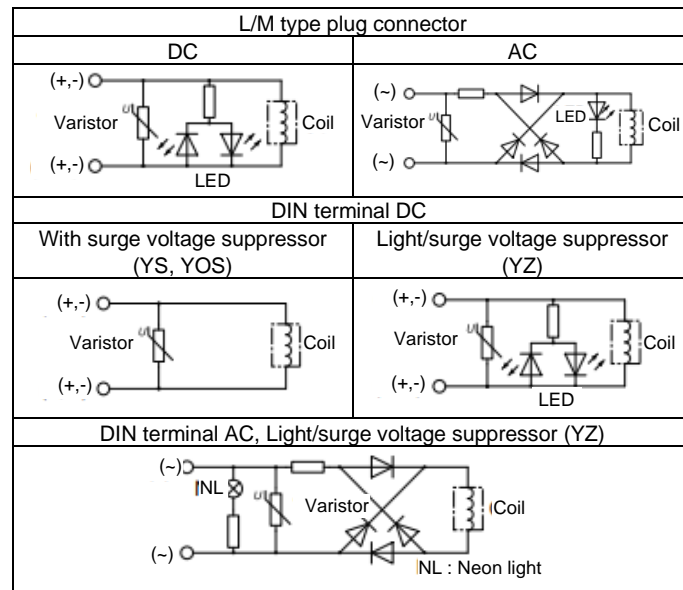

Figure 4

- Surge voltage suppressor of varistor has residual voltage corresponding to the protective element and rated voltage; therefore, protect the controller side from the surge.

3.9 Residual voltage

Caution

- The suppressor arrests the back EMF voltage from the coil to a level in proportion to the rated voltage.
- Ensure the transient voltage is within the specification of the host controller.
- Contact SMC for the varistor residual voltage.
- Valve response time is dependent on surge suppression method selected.

3.10 Countermeasure for surge voltage

Caution

- At times of sudden interruption of the power supply, the energy stored in a large inductive device may cause non-polar type valves in a de-energized state to switch.
- When installing a breaker circuit to isolate the power, install a surge absorption diode across the output of the breaker.

3.11 Extended periods of continuous energization

Warning

- Use standard (DC) specification for continuous duty.
- Refer to '3, 4, 5 port solenoid valves precautions' for more details.
- When solenoid valves are mounted in a control panel, employ measures to radiate excess heat, so that temperatures remain within the valve specification range. Use special caution when three or more adjacent valve stations are continuously energized. This will cause a rapid temperature rise; therefore, do not touch the valves.

3.12 Wiring

Caution

External force applied to lead wire

If an excessive force is applied to the lead wire, this may cause faulty wiring. Take appropriate measures so that a force of 30 N or more is not applied to the lead wire. When instructions are given to the Specific Product Precautions, follow these specifications.

3.12.1 How to use L/M type plug connector

Caution

3.12.1.1 Attaching and detaching connectors

Refer to catalogue for additional details.

3 Installation - continued

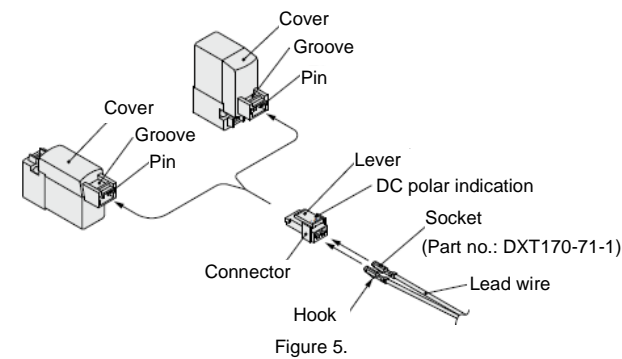

Figure 5.

3.12.2 Lead wire connection

3.12.2.1 Crimping connection of a lead wire and socket

Refer to catalogue for additional details.

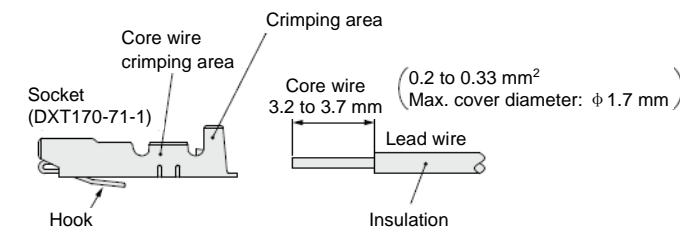

Figure 6.

3.12.3 Attaching and detaching sockets with lead wires

Refer to Specific Product Precautions in the catalogue for more details.

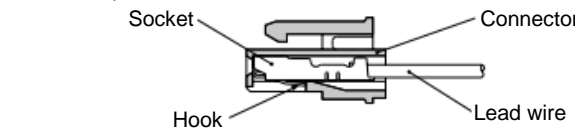

Figure 7.

3.13 How to use DIN connector

3.13.1 EN175301-803C (former DIN 43650C) (8 mm between pins)

Refer to catalogue for additional information.

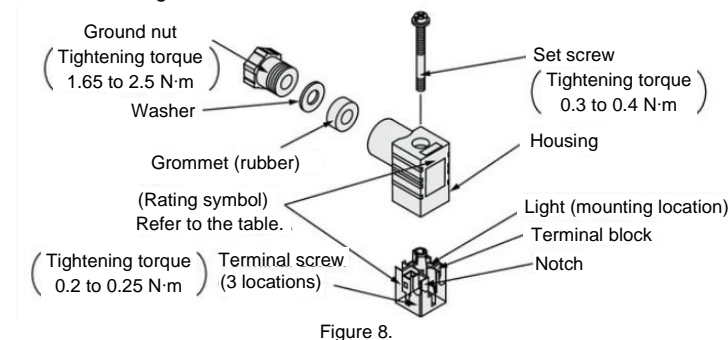

Figure 8.

Note 1) Applicable cable diameter Ø3.5 mm to Ø7 mm.

Note 2) (Reference) 0.5mm², 2-core or 3-core, equivalent to JIS C 3306.

3.14 Circuit diagram with light

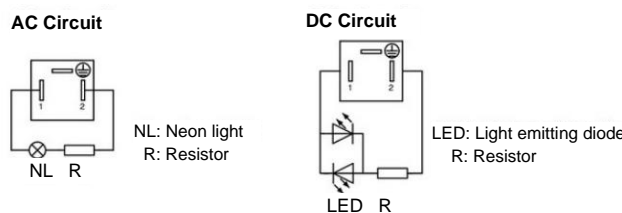

Figure 9.

3.15 Solenoid valve for AC specification

Warning

AC specification solenoid valves with grommet or L/M-type plug connector have a built-in rectifier circuit in the pilot section to operate the DC coil. With AC specification pilot valves, this built-in rectifier generates heat when energized. The surface may become hot depending on the energized condition; therefore, do not touch the solenoid valves.

3 Installation - continued

3.16 Precautions on other tube brands

Caution

Refer to the Specific Product Precautions in the fittings and tubing catalogue.

3.17 Effect of back pressure when using a manifold

Warning

Use caution when valves are used on a manifold, because an actuator may malfunction due to back-pressure.

For single acting cylinder, take appropriate measures to prevent malfunction.

4 How to Order

4.1 Standard products

Refer to catalogue for 'How to order' information.

Note: For VQZ125 follow the "How to order" options of VQZ115.

4.2 Special products

For special products (-X number) refer to product drawing for 'How to order' details and specifications.

5 Outline Dimensions

Refer to catalogue for outline dimensions.

6 Maintenance

6.1 General maintenance

Caution

- Not following proper maintenance procedures could cause the product to malfunction and lead to equipment damage.
- If handled improperly, compressed air can be dangerous.
- Maintenance of pneumatic systems should be performed only by qualified personnel.
- Before performing maintenance, turn off the power supply and be sure to cut off the supply pressure. Confirm that the air is released to atmosphere.
- After installation and maintenance, apply operating pressure and

power to the equipment and perform appropriate functional and leakage tests to make sure the equipment is installed correctly.

- If any electrical connections are disturbed during maintenance, ensure they are reconnected correctly and safety checks are carried out as required to ensure continued compliance with applicable national regulations.
- Do not make any modification to the product.
- Do not disassemble the product, unless required by installation or maintenance instructions.

6.2 Replacement parts

Refer to catalogue for details regarding replacement parts such as blanking plate assembly, blanking plug, DIN rain, silencer, port plug, plug connector assembly, one-touch fittings, pilot valve assembly, gasket and screw assembly, sub-plate and bracket assembly, and DIN connector.

6.2.1 One-touch fittings

The built-in fittings on the valve can be changed easily. Refer to Specific Product Precautions in the catalogue for more details.

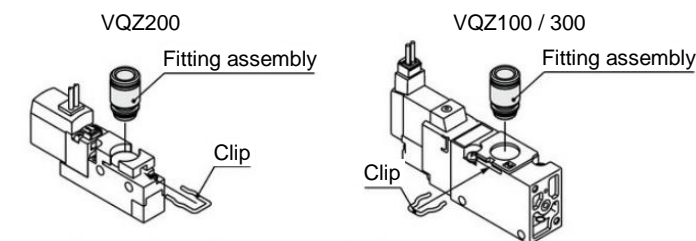

Figure 10.

6.2.2 Bracket assembly

Caution

Tightening torque when mounting a bracket on the valve is 0.25 to 0.35 N·m.

7 Limitations of Use

Warning

The system designer should determine the effect of the possible failure modes of the product on the system.

7.1 Limited warranty and disclaimer/compliance requirements

Refer to Handling Precautions for SMC Products.

Warning

7.2 Air/spring returned spool valves

7.2.1 Internal pilot type

For internal pilot type, the main valve returns to the original (de-energized) position by means of the spring when the air supply is cut. When only the electrical power is cut, the return is by means of the pilot pressure and spring force.

7.2.2 External pilot type

For external pilot type, the main valve returns to the original (de-energized) position by means of the spring when the main air supply, and the external pilot supply, is cut. When only the electrical power is cut, the return is by means of the external pilot pressure and spring force.

7.3 Holding of pressure

Since valves are subject to air leakage, they cannot be used for applications such as holding pressure (including vacuum) in a system.

7.4 Cannot be used as an emergency shut-off valve

This product is not designed for safety applications such as an emergency shut-off valve. If the valves are used in this type of system, other reliable safety assurance measures should be adopted.

7.5 Safety relays or PLC

If a safe output from a safety relay or PLC is used to operate this valve, ensure that any output test pulse duration is shorter than 1 ms to avoid the valve solenoid responding.

Caution

7.6 Leakage voltage

Ensure that any leakage voltage caused by the leakage current when the switching element is OFF is ≤3% of the rated voltage across the valve for

DC coils and ≤8% for AC coils.

7.7 Low temperature operation

Unless otherwise indicated in the specifications for each valve, operation is possible to -10°C, but appropriate measures should be taken to avoid solidification or freezing of drainage and moisture, etc.

8 Product disposal

This product shall not be disposed of as municipal waste. Check your local regulations and guidelines to dispose this product correctly, in order to reduce the impact on human health and the environment.

9 Contacts

Refer to www.smcworld.com or www.smc.eu for your local distributor/importer.

SMC Corporation

URL : <https://www.smcworld.com> (Global) <https://www.smc.eu> (Europe)
SMC Corporation, 4-14-1, Sotokanda, Chiyoda-ku, Tokyo 101-0021, Japan
Specifications are subject to change without prior notice from the manufacturer.
© 2022 SMC Corporation All Rights Reserved.
Template DKP50047-F-085I